

## AD 2 AERODROMES

## RJTT AD 2.1 AERODROME LOCATION INDICATOR AND NAME

## RJTT - TOKYO International

## RJTT AD 2.2 AERODROME GEOGRAPHICAL AND ADMINISTRATIVE DATA

1	ARP coordinates and site at AD	353312N/1394652E 301° /2.3km from RWY 34R THR
2	Direction and distance from (city)	14km (7.6nm) S of Tokyo Station (Japan Railway)
3	Elevation/ Reference temperature	21ft / 31°C (2004-2008)
4	Geoid undulation at AD ELEV PSN	117.6FT
5	MAG VAR/ Annual change	8°W (2021) /0.07°E
6	AD Administration, address, telephone, telefax, telex, AFS, e-mail and/or Web-site addresses	Civil Aviation Bureau, Ministry of Land, Infrastructure, Transport and Tourism. Tokyo International Airport, 3-1. 3-chome, Haneda-Kuko, Ota-ku, Tokyo, 144-0041 Japan. Tel : 03-5757-3000, Fax : 03-5756-1511 Tel(AIS) : 03-5756-1530(FPL only),1531,1532, Fax : 03-5756-1528 AFS : RJTTYFYX
7	Types of traffic permitted (IFR/VFR)	IFR/VFR
8	Remarks	Nil

## RJTT AD 2.3 OPERATIONAL HOURS

1	AD Administration	H24
2	Customs and immigration	H24
3	Health and sanitation	H24
4	AIS Briefing Office	H24
5	ATS Reporting Office(ARO)	Nil
6	MET Briefing Office	H24
7	ATS	H24
8	Fuelling	H24
9	Handling	H24
10	Security	H24
11	De-icing	Nil
12	Remarks	Nil

**RJTT AD 2.4 HANDLING SERVICES AND FACILITIES**

1	Cargo-handling facilities	All the modern institutions that deal with the weight thing to Boeing747-8F type freighter.
2	Fuel/ oil types	Fuel Grades : JET A-1 Oil grades : Turbine grades
3	Fuelling facilities / capacity	Hydrant refueling, fuel truck/Not limitation
4	De-icing facilities	Nil
5	Hangar space for visiting aircraft	Nil
6	Repair facilities for visiting aircraft	Nil
7	Remarks	Nil

**RJTT AD 2.5 PASSENGER FACILITIES**

1	Hotels	At Airport
2	Restaurants	At Airport
3	Transportation	Monorail, Railways, Busses and Taxis
4	Medical facilities	First aid treatment, ambulance
5	Bank and Post Office	At Airport
6	Tourist Office	At Airport
7	Remarks	Nil

**RJTT AD 2.6 RESCUE AND FIRE FIGHTING SERVICES**

1	AD category for fire fighting	CAT 10
2	Rescue equipment	Chemical fire fighting truck x 5, Water-supply truck, Lighting power supply truck, Emergency medical equipments conveyance truck
3	Capability for removal of disabled aircraft	To be issued later
4	Remarks	Nil

**RJTT AD 2.7 SEASONAL AVAILABILITY-CLEARING**

1	Types of clearing equipment	Snow remove equipments: 1) 6 snow sweepers 2) 8 snow plows 3) 2 rotaries 4) 2 motor graders 5) 5 loaders
2	Clearance priorities	1) RWY16R/34L and 16L/34R, Taxiways attached to the RWY 2) RWY04/22 and 05/23, Taxiways attached to the RWY
3	Remarks	Seasonal availability : All seasons. Snow removal will be commenced, if the RWY and TWY are covered with a depth of 3cm snow or more.



RJTT AD 2.8 APRONS, TAXIWAYS AND CHECK LOCATIONS DATA

1	Apron surface and strength	<p>Terminal 1, Terminal 2 Surface : Concrete Strength : PCN 74/R/B/X/T</p> <p>Terminal 3 Surface : Concrete Strength : PCN 78/R/B/X/T</p> <p>N Area Surface : Concrete Strength : PCN 48/R/B/X/T</p> <p>N Area Spot NR951-956, 961-969 Surface : Concrete Strength : PCN 91/R/B/X/T</p> <p>Compass Area Surface : Concrete Strength : PCN 74/R/B/X/T</p>
2	Taxiway width, surface and strength	<p>Surface : Asphalt-concrete, concrete Strength : PCN 75/F/B/X/T, PCN 74/R/B/X/T Width :</p> <p>34m(111FT) : A6, A9, A11, B2, B5, B7, C8, C9, E3(between C and E), E4, E5, E8(between C and E), E9(between C and E), E12(between C and E), G(between C and E), H(between A and W), H(between C and E), J(between A and W), J(between C and E), K(between A and W), L4, L6, L9, L11, M2(between C and E), W6 THRU W10, W11(between A and W), W13</p> <p>32m(105FT) : A1, A2, A4, B1, C1, E1, E2, E10(between C and E), G(between A and W), K(between C and E), L3, R(between G and H), R(between K and J), W1</p> <p>30m(98FT) : A, A3, A5, A7, A8 THRU A10, A12 THRU A16, B, B3, B4, B6, B8 THRU B14, C, C2 THRU C7, C10 THRU C14, D, D1 THRU D7, E3(between E and R), E, E8(between E and R), E9(between E and R), E10(from spot NR55 to spot NR51), E12(between E and R), G(between E and W), H(between E and W), H1, H2, R1, J(between E and W), J1, J2, K(between E and W), L, L5, L10, L12 THRU L16, M, M1, M2(between E and R), N(between spot NR981 and N7), N1, N5, N7, P, P3 THRU P11, Q, Q1, Q2, R(between A and G), R(between E8 and E9), R(between E10 and J), R(between K and C), R(between A and S), S, S1 THRU S3, T, T1 THRU T9, T11, T12, T14, U2, U4, V, W, W11(between W and R1), Y1</p> <p>23m(75FT) : Other</p>
3	ACL and elevation	Not available
4	VOR checkpoints	Not available

5	INS checkpoints	<p><i>Spot NR</i></p> <p>1 : 353244.87N/1394715.45E      101 : 353235.61N/1394632.63E                  2 : 353243.91N/1394713.19E      102 : 353234.38N/1394630.02E                  3 : 353242.77N/1394710.79E      103 : 353233.14N/1394627.41E                  4 : 353241.67N/1394708.47E      104 : 353231.90N/1394624.80E                  5R : 353240.61N/1394706.99E      105F : 353230.68N/1394622.23E                  5 : 353240.85N/1394707.04E      105P : 353230.91N/1394620.33E                  5L : 353240.41N/1394705.84E      106 : 353233.11N/1394618.77E                  6 : 353241.75N/1394705.46E      106R : 353233.52N/1394618.36E                  7 : 353243.30N/1394705.33E      106L : 353233.25N/1394620.00E                  8 : 353245.27N/1394705.86E      107 : 353236.04N/1394617.83E                  9 : 353248.11N/1394704.81E      107R : 353236.45N/1394617.42E                  10 : 353250.36N/1394703.25E      107L : 353236.11N/1394619.13E                  11 : 353252.33N/1394700.22E      108 : 353238.48N/1394616.10E                  12 : 353252.76N/1394658.54E      108R : 353238.89N/1394615.69E                  13 : 353254.41N/1394657.37E      108L : 353238.58N/1394617.37E                  14 : 353255.85N/1394657.64E      109 : 353240.52N/1394614.66E                  15 : 353258.98N/1394657.09E      110 : 353242.55N/1394613.21E                  16 : 353301.21N/1394655.50E      111 : 353244.59N/1394611.77E                  17 : 353303.24N/1394652.77E      112 : 353246.90N/1394610.12E                  18 : 353303.50N/1394650.89E      113 : 353248.94N/1394608.68E                  19 : 353304.80N/1394648.96E      114 : 353250.97N/1394607.23E                  20 : 353306.09N/1394648.17E                  21 : 353306.70N/1394649.16E                  22 : 353307.44N/1394651.14E                  23 : 353308.19N/1394653.09E                  24 : 353309.70N/1394655.12E</p> <p>31 : 353313.19N/1394648.39E                  32 : 353314.60N/1394647.42E                  33 : 353316.57N/1394646.03E                  34 : 353318.53N/1394644.64E                  35 : 353320.50N/1394643.24E                  36 : 353322.46N/1394641.85E                  37 : 353324.43N/1394640.45E                  38 : 353326.39N/1394639.06E                  39 : 353328.36N/1394637.66E                  40 : 353330.32N/1394636.27E                  41 : 353332.28N/1394634.87E</p> <p>51 : 353316.97N/1394710.41E                  52 : 353318.11N/1394712.58E                  53 : 353319.25N/1394714.98E                  54 : 353320.22N/1394717.28E                  55 : 353321.20N/1394719.34E                  56 : 353318.42N/1394721.31E                  57 : 353317.26N/1394719.15E                  58 : 353314.90N/1394715.68E                  59 : 353311.22N/1394717.32E                  60 : 353309.26N/1394718.72E                  61 : 353307.29N/1394720.11E                  62 : 353305.33N/1394721.51E                  63 : 353303.36N/1394722.90E                  64 : 353301.40N/1394724.30E                  65 : 353259.43N/1394725.69E                  66 : 353256.29N/1394729.18E                  67R : 353257.40N/1394732.54E                  67 : 353257.49N/1394732.99E                  67L : 353258.73N/1394733.01E                  68 : 353258.54N/1394734.99E                  69 : 353255.82N/1394737.27E                  70 : 353254.33N/1394735.67E                  71 : 353253.92N/1394733.45E                  72 : 353252.85N/1394731.08E                  73 : 353251.67N/1394728.59E                  81 : 353313.04N/1394725.84E                  82 : 353311.01N/1394727.27E                  83 : 353306.60N/1394730.41E                  84 : 353304.57N/1394731.84E</p> <p>121 : 353240.65N/1394626.06E                  122 : 353242.75N/1394624.57E                  123 : 353247.53N/1394621.33E                  124 : 353249.20N/1394620.14E</p> <p>131 : 353241.47N/1394627.80E                  132 : 353243.58N/1394626.30E                  133 : 353248.25N/1394622.84E                  134 : 353249.91N/1394621.66E</p> <p>140 : 353254.40N/1394614.86E                  141 : 353255.60N/1394617.04E                  142 : 353300.16N/1394613.74E                  143 : 353258.90N/1394611.08E                  144 : 353257.70N/1394608.54E                  145 : 353256.46N/1394605.92E                  146 : 353255.26N/1394603.39E                  147 : 353253.79N/1394600.30E                  148 : 353252.61N/1394557.81E                  149 : 353251.43N/1394555.32E</p> <p>151 : 353306.65N/1394610.75E                  152 : 353305.54N/1394608.40E                  153 : 353304.42N/1394606.05E                  154 : 353303.31N/1394603.69E                  155 : 353302.19N/1394601.34E</p> <p>201 : 353204.82N/1394732.11E                  202 : 353206.22N/1394731.32E                  203 : 353208.26N/1394730.08E                  204 : 353210.22N/1394728.69E                  205 : 353212.18N/1394727.29E                  206 : 353214.15N/1394725.90E                  207 : 353216.11N/1394724.51E                  208 : 353218.08N/1394723.11E                  209 : 353220.04N/1394721.72E                  210 : 353222.10N/1394720.51E                  211 : 353223.98N/1394718.93E                  212 : 353226.39N/1394717.22E                  213 : 353228.44N/1394716.01E                  214 : 353230.32N/1394714.43E</p>
---	-----------------	--

5	INS checkpoints	<p><i>Spot NR</i></p> <p>301 : 353346.49N/1394639.93E      701 : 353244.66N/1394744.06E  302 : 353347.63N/1394642.33E      702 : 353242.69N/1394745.45E  303 : 353348.77N/1394644.73E      703 : 353240.73N/1394746.85E  304 : 353349.54N/1394647.40E      704 : 353238.69N/1394748.09E  305 : 353350.96N/1394649.27E      705 : 353236.95N/1394749.96E  311 : 353345.88N/1394639.02E      706 : 353234.93N/1394751.24E  312 : 353346.52N/1394641.55E      707 : 353232.78N/1394752.46E  313 : 353347.66N/1394643.96E      708 : 353227.03N/1394756.76E  314 : 353349.22N/1394646.06E      709 : 353224.95N/1394758.47E  315 : 353349.85N/1394648.59E      710 : 353223.03N/1394759.83E    711 : 353220.90N/1394801.11E  712 : 353218.93N/1394802.74E    331 : 353359.72N/1394651.90E      801 : 353243.57N/1394744.54E  332 : 353355.35N/1394656.39E      802 : 353241.85N/1394746.45E  333 : 353353.78N/1394658.18E      803 : 353239.66N/1394747.37E  341 : 353400.48N/1394651.39E      804 : 353238.00N/1394749.39E  342 : 353359.07N/1394653.13E      805 : 353235.73N/1394750.16E  343 : 353354.96N/1394657.15E      806 : 353233.68N/1394751.61E  344 : 353353.92N/1394659.52E      807 : 353232.03N/1394753.62E    808 : 353225.94N/1394757.33E  809 : 353223.75N/1394758.66E  810 : 353221.85N/1394800.23E  811 : 353219.87N/1394801.65E    901 : 353308.45N/1394528.21E  902 : 353310.37N/1394529.86E  903 : 353312.29N/1394531.51E  904 : 353314.22N/1394533.16E  905 : 353316.15N/1394534.81E  906 : 353318.08N/1394536.46E  907 : 353320.00N/1394538.11E  908 : 353321.93N/1394539.77E  909 : 353323.10N/1394541.72E    401R : 353336.59N/1394658.56E      951 : 353333.71N/1394541.04E  401 : 353335.21N/1394659.00E      952 : 353335.65N/1394539.40E  402 : 353333.22N/1394700.44E      953 : 353337.58N/1394537.76E    954 : 353339.52N/1394536.13E  955 : 353341.45N/1394534.49E  956 : 353343.39N/1394532.86E    406 : 353331.04N/1394702.17E  407 : 353329.08N/1394703.57E  408 : 353327.11N/1394704.96E      961 : 353343.77N/1394524.31E  501 : 353345.29N/1394702.69E      962 : 353344.36N/1394525.56E  502 : 353343.54N/1394704.16E      963 : 353344.95N/1394526.80E  503 : 353341.52N/1394705.44E      964 : 353345.54N/1394528.05E  504 : 353339.55N/1394706.83E      965 : 353346.13N/1394529.29E  505 : 353334.60N/1394710.28E      966 : 353346.72N/1394530.54E  506 : 353332.80N/1394711.63E      967 : 353347.31N/1394531.79E  507 : 353330.89N/1394713.13E      968 : 353347.90N/1394533.03E  508 : 353328.92N/1394714.53E      969 : 353348.59N/1394534.48E  509 : 353326.96N/1394715.92E    981 : 353302.38N/1394519.18E  982 : 353306.41N/1394518.19E  983 : 353308.63N/1394518.73E  984 : 353310.56N/1394520.38E  985 : 353312.21N/1394522.64E    601 : 353238.52N/1394736.98E  602 : 353236.85N/1394738.16E  603 : 353235.18N/1394739.35E  604 : 353233.10N/1394740.97E  605 : 353231.06N/1394742.41E    V1 : 353322.75N/1394707.47E  V2 : 353324.85N/1394705.98E  VN : 353341.08N/1394654.86E  VS : 353338.04N/1394656.82E</p>
6	Remarks	Nil

## RJTT AD 2.9 SURFACE MOVEMENT GUIDANCE AND CONTROL SYSTEM AND MARKINGS

1	Use of aircraft stand ID signs, TWY guide lines and Visual docking/ parking guidance system of aircraft stands	ACFT stand ID sign : NR1 THRU NR4, NR5, NR6 THRU NR24, NR51 THRU NR66, NR67, NR68 THRU NR73, NR105P, NR106, NR107, NR108, NR109 THRU NR114, NR140 THRU NR149, NR406 THRU NR408 ACFT stand taxi lane : E8(BTN E and R), E9(BTN E and R), R(from E8 to E9) Visual docking guidance system : See below figure
2	RWY and TWY markings and LGT	<p>RWY: RWY 16L/34R, 16R/34L, 04/22, 05/23 (Marking) RWY designation, RWY CL, RWY THR, Aiming point, TDZ, RWY side stripe, RWY middle point, Displaced THR(RWY 16L/34R, 16R) (LGT) RCLL, REDL, RTHL, RENL, RTZL(RWY16L/34R, 16R/34L, 22, 23), WBAR(RWY16L/34R, 16R/34L, 22, 23)</p> <p>TWY: C10, D3 and D5 (LGT) Rapid exit taxiway indicator lights</p> <p>TWY: ALL TWY (Marking) TWY CL, RWY HLDG PSN, TWY side stripe (LGT) TWY edge LGT(except F), TWY CL LGT(except B12, D(between D7 and E), F, N1, N2, N3, N4, N, Y(between SPOT 312 and J2)), Taxiing guidance sign(except B12) TWY CL LGT on C4, C6, C7, C10, C11, B4, B6, T4, T6, A2, A5, A10, A12, L5 and L12 The intensity of the TWY CL LGT is more increased than that of other TWY CL LGT.</p> <p>TWY: C1 THRU C14 (LGT) Stop bar LGT, RWY guard LGT(90m off the runway center line)</p> <p>TWY: A1 THRU A16, C1, C2, C3, C5, C12, C13, C14, D1 THRU D5, L3 THRU L16 (LGT) RWY guard LGT(75m off the runway center line)</p> <p>TWY: A, E, M, R (Marking) Intermediate Holding Position (LGT) Intermediate Holding Position (see attached chart)</p> <p>TWY: A1, A3, A4, A6, A11, A13, A14, A15, A16, B1, B2, B5, B7, B9, B10, B11, L3, L4, L6, L11, L14, L15, L16, T1, T2, T5, T7, T9, T11 (LGT)Variable Message Signs (RWY status LGT) (see attached chart)</p> <p>SFC painted direction sign (See Figure "Type of Surface Painted Markings")</p>
3	Stop bars	<p>Stop Bar Lights Operations</p> <ol style="list-style-type: none"> <li>1) Stop Bar Lights are installed at each RWY holding position associated with RWY16L/34R</li> <li>2) Stop Bar Lights will be operated when the visibility or the lowest RVR of the RWY16L/34R is at or less than 600m.</li> <li>3) Stop Bar Lights on TWY C1, C2, C13 and C14 are controlled individually by ATC</li> <li>4) Stop Bar Lights on TWY C3 THRU C12 are not controlled individually by ATC.</li> <li>5) During the period Stop Bar Lights operated, TWY C3 THRU C12 are not available for departure aircraft.</li> </ol>
4	Remarks	<p>(Marking) Overrun area, ACFT PRKG PSN, Apron TWY CL (LGT) Apron flood LGT</p> <p>Runway Guard Lights Operations: Either Runway Guard Lights of 75m off runway center line or Runway Guard Lights of 90m off runway center line turn on in the daytime regardless of visibility condition of TWY C1, C2, C3, C5, C12, C13, C14</p>

MARKING AIDS

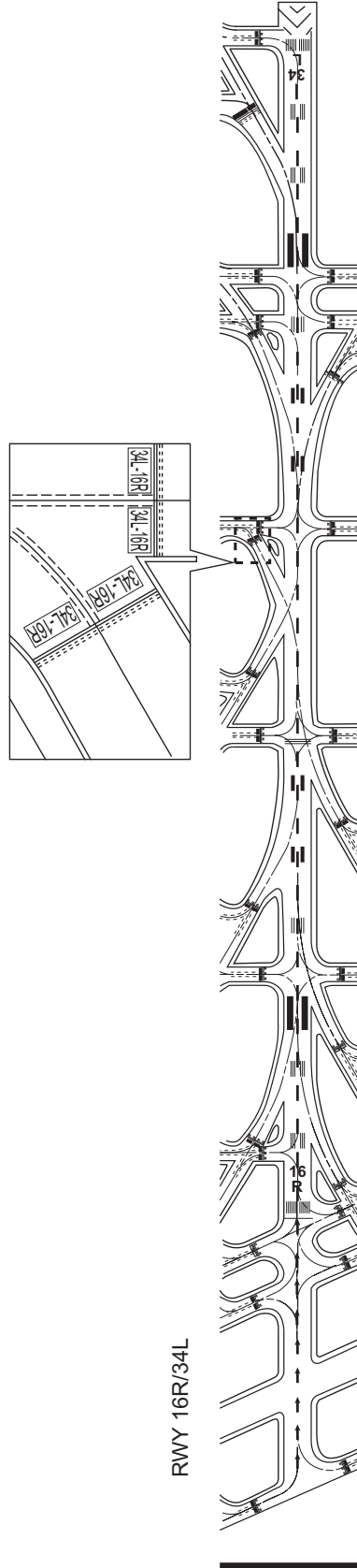
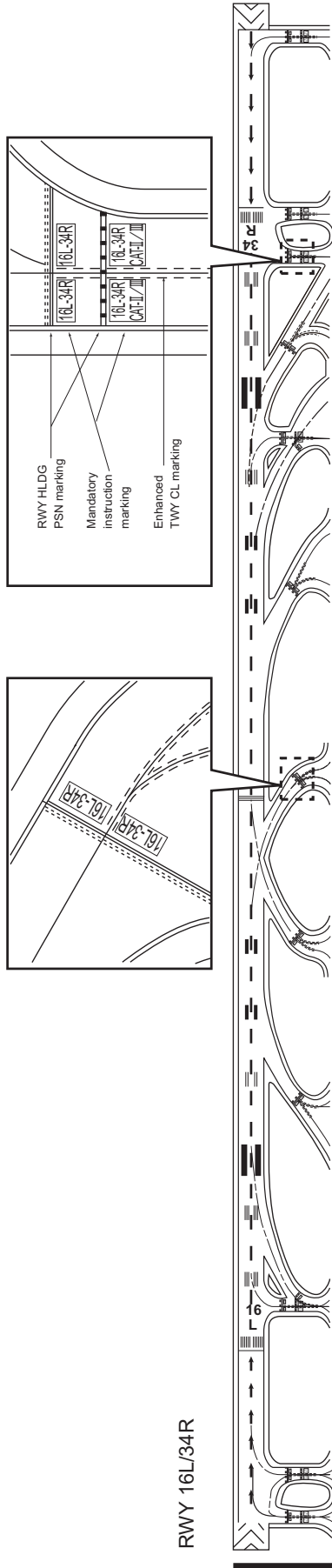

MARKING AIDS

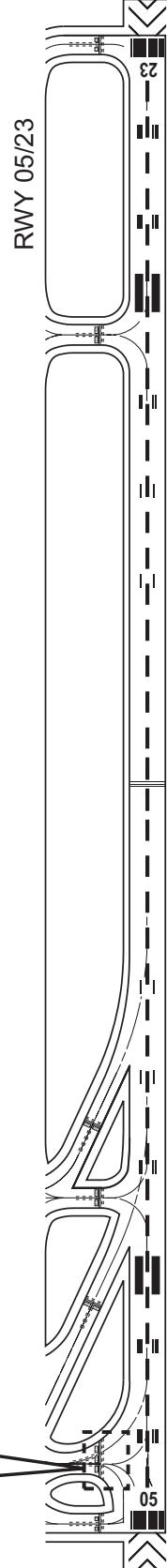
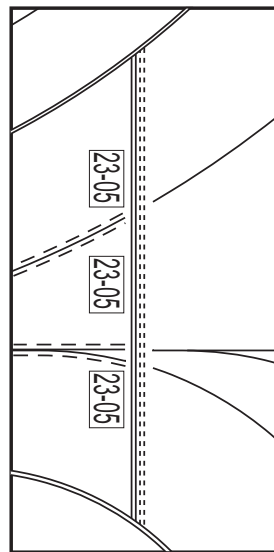
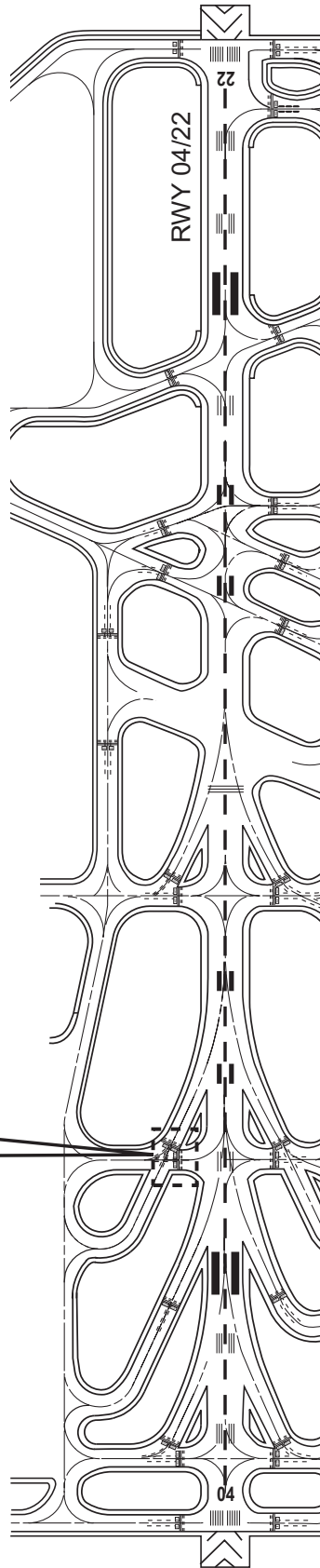
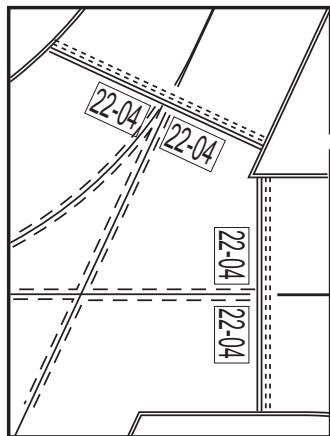

**Intermediate Holding Position Marking and Intermediate Holding Position Lights**

1. The Intermediate Holding Position Marking indicates the position where aircraft is to hold to prevent collision with other aircraft on the taxiway. The Intermediate Holding Position Lights are collocated with the Intermediate Holding Position Marking and synchronized with the taxiway center line lights. The Intermediate Holding Position Lights consist of 5 yellow lights and the Intermediate Holding Position Marking is a single broken line as illustrated in the figure below;

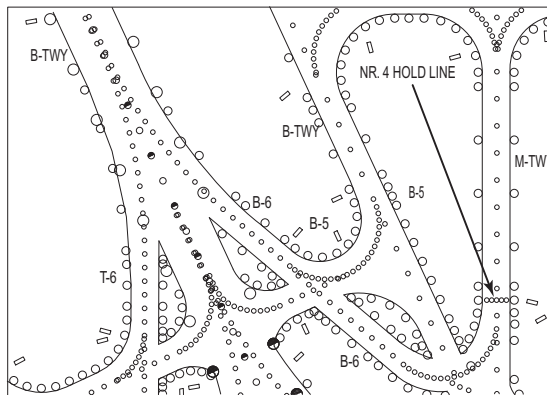
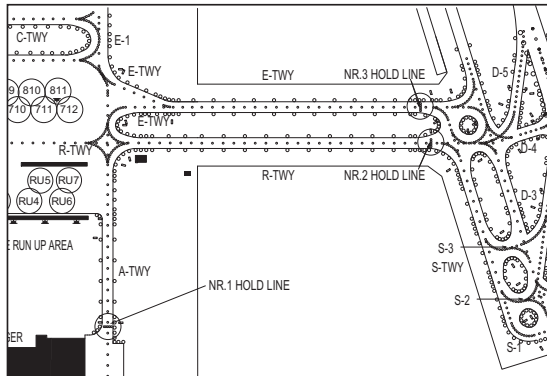
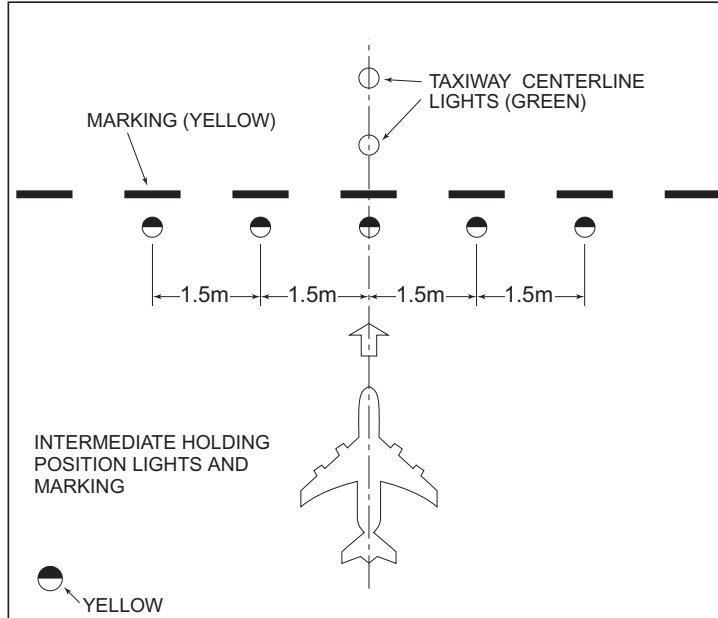

2. Operational procedure  
See AD 2.20.6.4.

### Variable Message Signs (VMS)

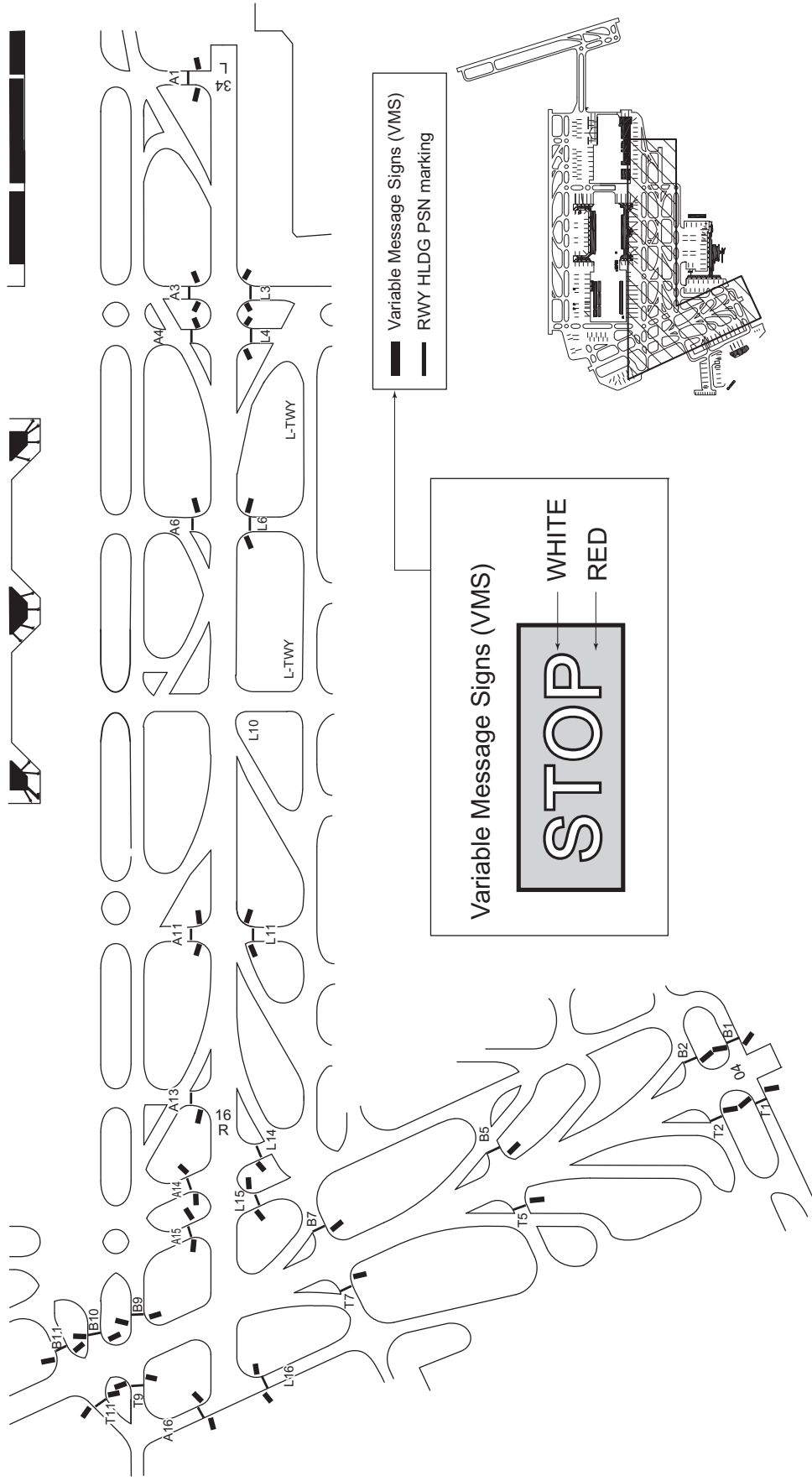

NOTE : The TWY names and RWY HLDG PSN markings in this ATTACHMENT are depicted only for the TWYs where VMS are installed.



## Type of Surface Painted Markings

### 1.Type of Surface Painted Markings

- Surface Painted Direction Sign

This type of marking at a taxiway intersection indicates the designation and direction of the taxiway leading out of an intersection. Black inscriptions with an arrow with a yellow background.

- Surface Painted Location Sign

This type of marking indicates the designation of the taxiway on which the aircraft is located. Yellow inscriptions with a black background and yellow frame.

2.On each of the taxiways A, A14, A15, A16, B, B6, B7, B9, B10, F, H, J, K, L, L13, L15, L16, M, N, N2, N3, N4, N5, T, T7, T9, T11, U2, U4, W, surface painted markings are provided (refer attached drawing).

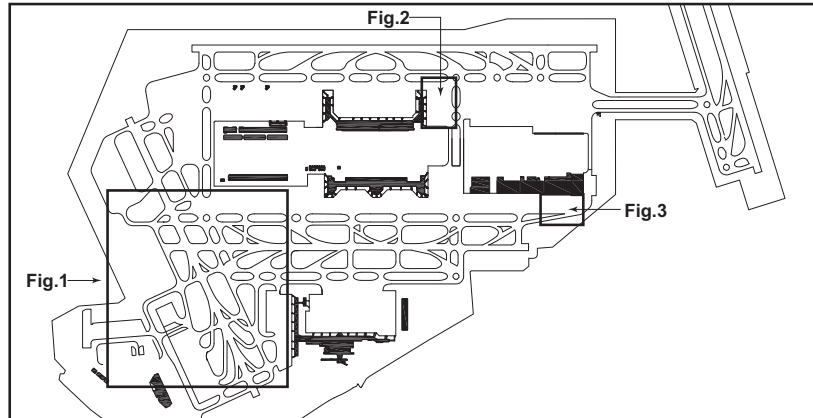
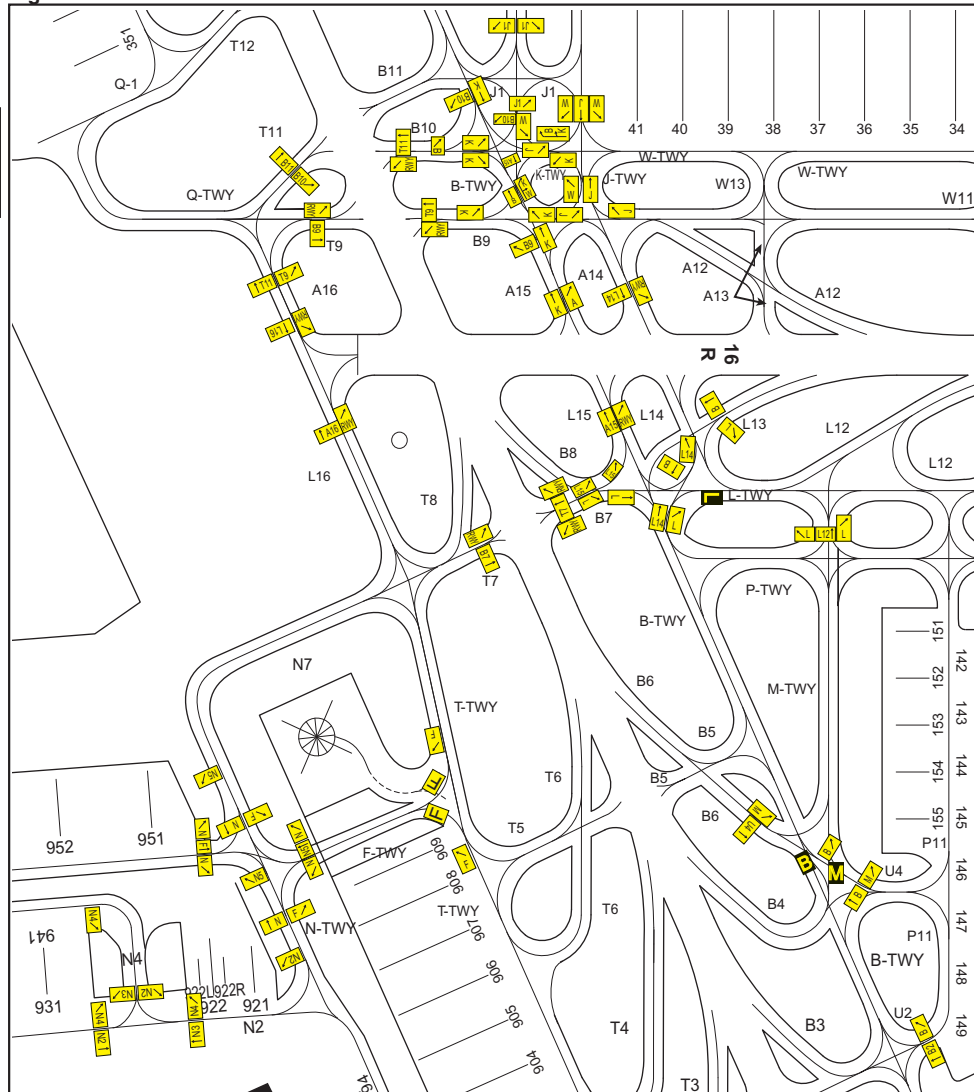
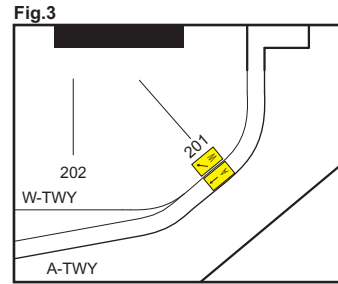
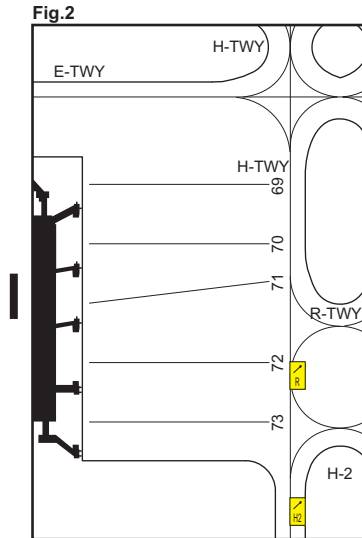

Fig.1





**VISUAL DOCKING GUIDANCE SYSTEM**

**I. SAFEDOCK**

**1. General**

(1) Aircraft parking stands NR1 THRU NR4, NR5, NR6 THRU NR24, NR51 THRU NR66, NR67, NR68 THRU NR73, NR105P, NR106, NR107, NR108, NR109 THRU NR114, NR140 THRU NR149, NR406 THRU NR408 are equipped with a SAFEDOCK visual docking guidance system.

The pilots of an arriving aircraft assigned to park at one of these parking stands can use this system to be guided and stop the aircraft at the correct parking position.

(2) This system is operational only in the automatic mode and in an event of a system failure, the aircraft shall be manually guided by a marshaller to the stopping position.

(3) The SAFEDOCK visual docking system consists of a display screen for pilots and a laser scanner.

The system detects and analyses the aircraft type of an approaching aircraft, tracks it through the laser scanner, and displays these results on the display screen.

(4) The display screen indicates the following information:

- a) type of the approaching aircraft
- b) deviation from the lead-in center line, and
- c) distance to the stopping position.

The above information is provided equally to the pilots on both left seat and right seat.

**2. Aircraft Type Indication**

(1) A message about the aircraft type from Spot Control System shall be confirmed and put into the system by ground operator.

The system then carries out internal calibration and starts laser scanning simultaneously.

The system shows the aircraft type on the display screen and then will begin to indicate yellow lead-in arrows scrolling upwards prompting the aircraft to proceed.(Fig.1)

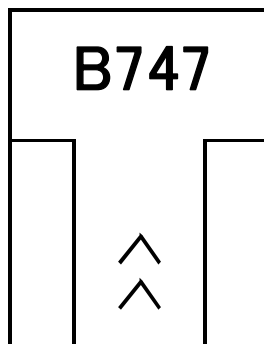

Fig.1

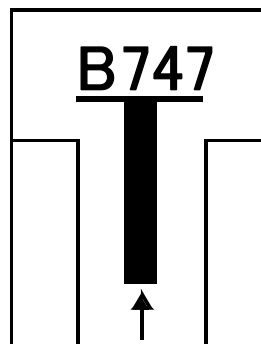

Fig.2

(2) When the laser scanner detects the approaching aircraft, the display screen will indicate the aircraft type, a "T" bar, and a lead-in upward arrow in yellow.(Fig.2)

(3) At least until the approaching aircraft arrives at a point 12 meters before the stopping position, the system will identify the aircraft type and will compare with the previously input aircraft type, If these data match, the system will continue its operation. If they do not match, the display screen will repeatedly indicate "STOP", "ID" and "FAIL" in sequence and will indicate 2 illuminated red squares simultaneously.

NOTE:At this moment, the pilots must stop the aircraft immediately.

When the operator re-input the correct aircraft type into the system and the system finds it correct, it resumes normal operations indicating the correct aircraft type on its display screen

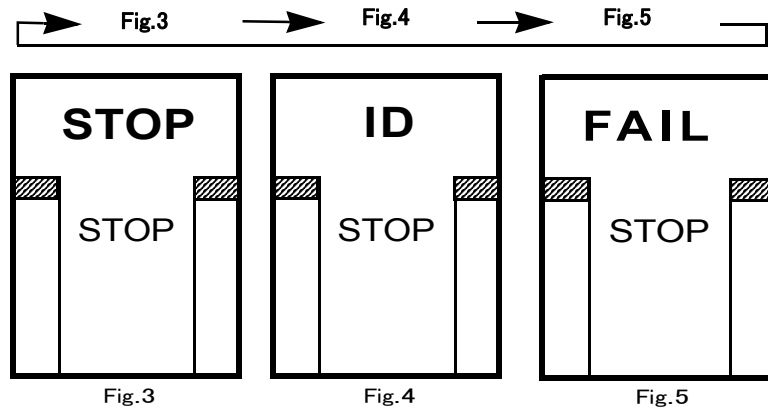

3. Taxiing and Lateral Center line Guidance

- (1) While taxiing the aircraft using the system, the pilots should maneuver the aircraft at a low speed to the stopping position. In an event when "SLOW" is indicated on the display screen, the pilots should further decelerate the taxiing speed to avoid overshooting.(Fig.6)

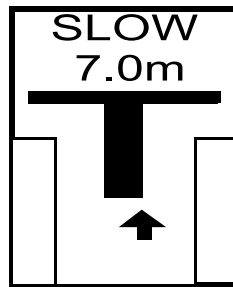

Fig.6

- (2) Deviation of an upward yellow arrow from the center line of "T" indicates the deviation of the approaching aircraft relative to the center line of the parking stand either to right or left. Further, an additional flashing red arrow on the either side indicates the required direction for the aircraft to turn.(Fig.7, Fig.8)

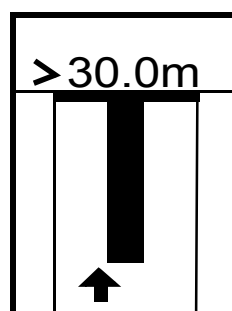

Fig.7

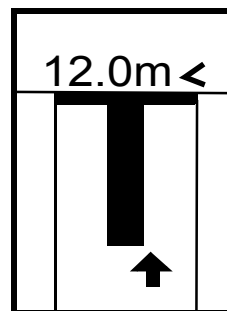

Fig.8

4. Stop Guidance

- (1) When the approaching aircraft is within 30 meters from the stopping position, display of digital countdown will start. As the aircraft approaches the stopping position, digital countdown is for every 1.0 meter(from 30.0 to 2.0 meters to the stop position) or for every 0.2 meters (from 2.0 to 0.0 meters to the stop position).

- (2) When the approaching aircraft is within 16 meters from the stopping position, the shaft of the illuminated "T" will start to reduce in its length from the bottom to indicate the approaching rate of the aircraft, indicating the remaining distance to the stopping position successively.(Fig.9, Fig.10)  
As the aircraft approaches the stopping position, the shaft of the illuminated "T" retract one row for every 0.5 meters.

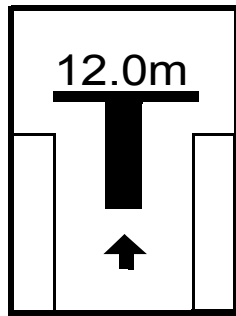

Fig.9

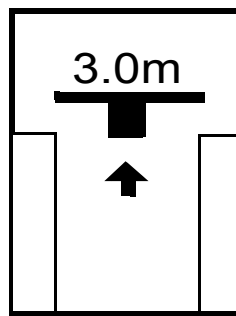

Fig.10

- (3) When the aircraft reaches the stopping position, a message "STOP" will be displayed on the screen together with two red squares, one each at the either side of the screen at the positions previously used for indication of a direction to turn. (Fig.11)

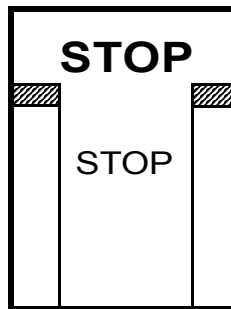

Fig.11

- (4) When the aircraft is stopped at the correct stopping position, a message "OK" will be displayed on the screen in several seconds.(Fig.12)

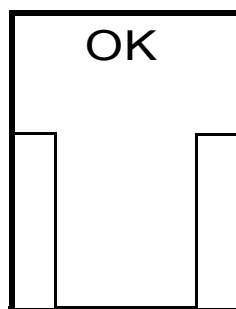

Fig.12

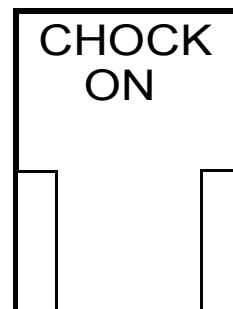

Fig.13

- (5) When the operator applies chocks, and switches on "CHOCK ON" switch, the display screen will display "CHOCK ON".(Fig.13)

- (6) If the aircraft stops at a position beyond the correct stopping position, a message "TOO FAR" will be displayed on the screen.(Fig 14).

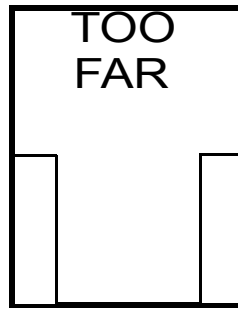

Fig.14

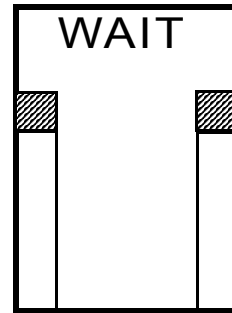

Fig.15

5. Cautions and Safety

- (1) When the system displays an incorrect aircraft type, or when such a message as "STOP", "ID", "FAIL", or "WAIT" appears on the display screen, the pilots should stop the aircraft immediately. (Fig.3, Fig.4, Fig.5, Fig.11, Fig.15)
- (2) Bad weather condition, during heavy fog, rain or snow, the visibility for the docking system can be reduced. When the system is activated and in capture mode, the display screen will deactivate the floating arrows and indicate "Aircraft type" and "SLOW".  
This message will be superseded by the "T" bar, as soon as the system detects the approaching aircraft.  
The pilot must not proceed beyond the bridge, unless the "SLOW" text has been superseded by the "T" bar.

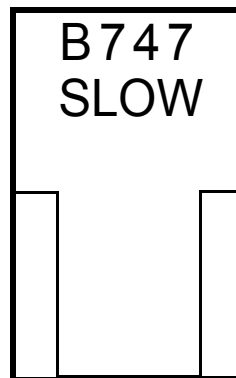

Fig.16

- (3) System breakdown, in case of a severe system failure, the display screen will go black, except for 2 red squares indicator. A manual backup procedure must be used for docking guidance.(Fig.17)

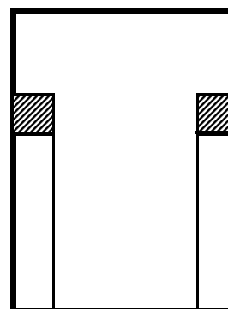

Fig.17

## RJTT AD 2.10 AERODROME OBSTACLES

SEE RJTT AD2.24 AERODROME OBSTRUCTION CHART-ICAO

In approach / TKOF Areas

RWY/Area affected	Obstacle type	Coordinates	Elevation	Markings/LGT	Remarks
-	Lightning Rod	353218.52N 1394402.50E	217ft	-/-	above the conical surface
-	Lightning Rod	353218.50N 1394404.09E	220ft	-/LGTD	above the conical surface
-	Lightning Rod	353218.50N 1394404.56E	217ft	-/-	above the conical surface
-	Lightning Rod	353219.07N 1394404.53E	217ft	-/-	above the conical surface
-	Lightning Rod	353219.69N 1394404.53E	217ft	-/LGTD	above the conical surface
-	Lightning Rod	353220.08N 1394404.55E	217ft	-/-	above the conical surface
-	Chimney	353050.7N 1394547.4E	291ft	-/LGTD	above the conical surface
-	Building	353958.9N 1394459.0E	875ft	-/LGTD	above the conical surface
-	Building	353951.2N 1394415.7E	893ft	-/LGTD	above the conical surface

In circling area and at AD

Obstacle type	Coordinates	Elevation	Markings/ LGT	Remarks
Chimney	353107.42N 1394619.09E	177ft	-/LGTD	above the horizontal surface

## RJTT AD 2.11 METEOROLOGICAL INFORMATION PROVIDED

1	Associated MET Office	TOKYO
2	Hours of service MET Office outside hours	H24
3	Office responsible for TAF preparation Periods of validity	TOKYO 30 Hours
4	Trend forecast Interval of issuance	TREND 30min
5	Briefing/ consultation provided	P, Ja, En
6	Flight documentation Language(s) used	C En
7	Charts and other information available for briefing or consultation	S <sub>6</sub> , U <sub>85</sub> , U <sub>7</sub> , U <sub>5</sub> , U <sub>3</sub> , U <sub>25</sub> , U <sub>2</sub> /T <sub>r</sub> , P <sub>S</sub> , P <sub>5</sub> , P <sub>3</sub> , P <sub>25</sub> , P <sub>SWE</sub> , P <sub>SWF</sub> , P <sub>SWG</sub> , P <sub>SWI</sub> , P <sub>SWM</sub> , P <sub>SW</sub> (domestic), E, C, W <sub>E</sub> , W <sub>F</sub> , W <sub>G</sub> , W <sub>I</sub> , W, N
8	Supplementary equipment available for providing information	Doppler Radar and Lidars for Airport Weather(see attached chart)
9	ATS units provided with information	TWR, APP, ATIS
10	Additional information(limitation of service, etc.)	Nil

### Airspace for the advisory service concerning low level wind shear (RWY16L/34R)

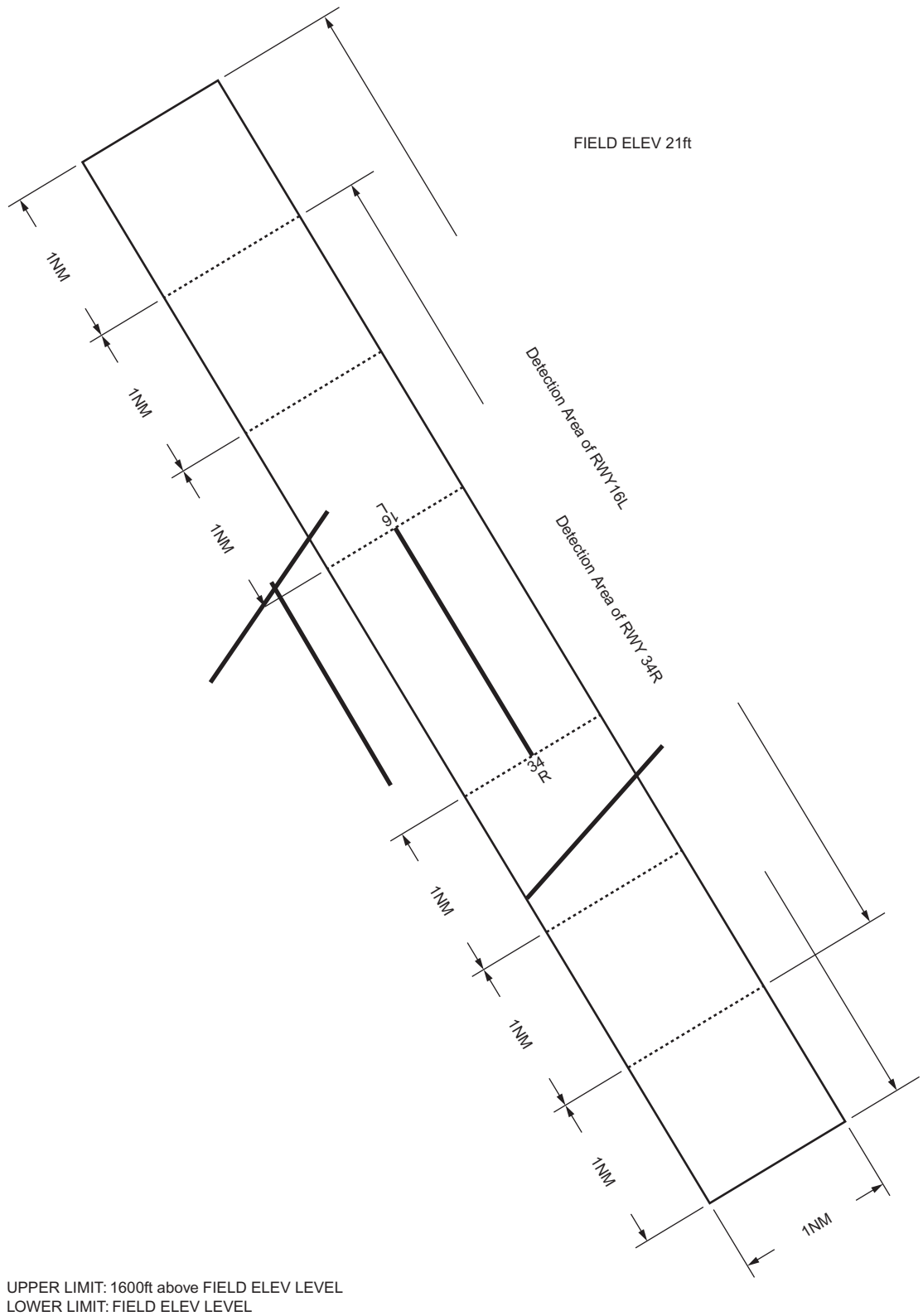

### Airspace for the advisory service concerning low level wind shear (RWY16R/34L)

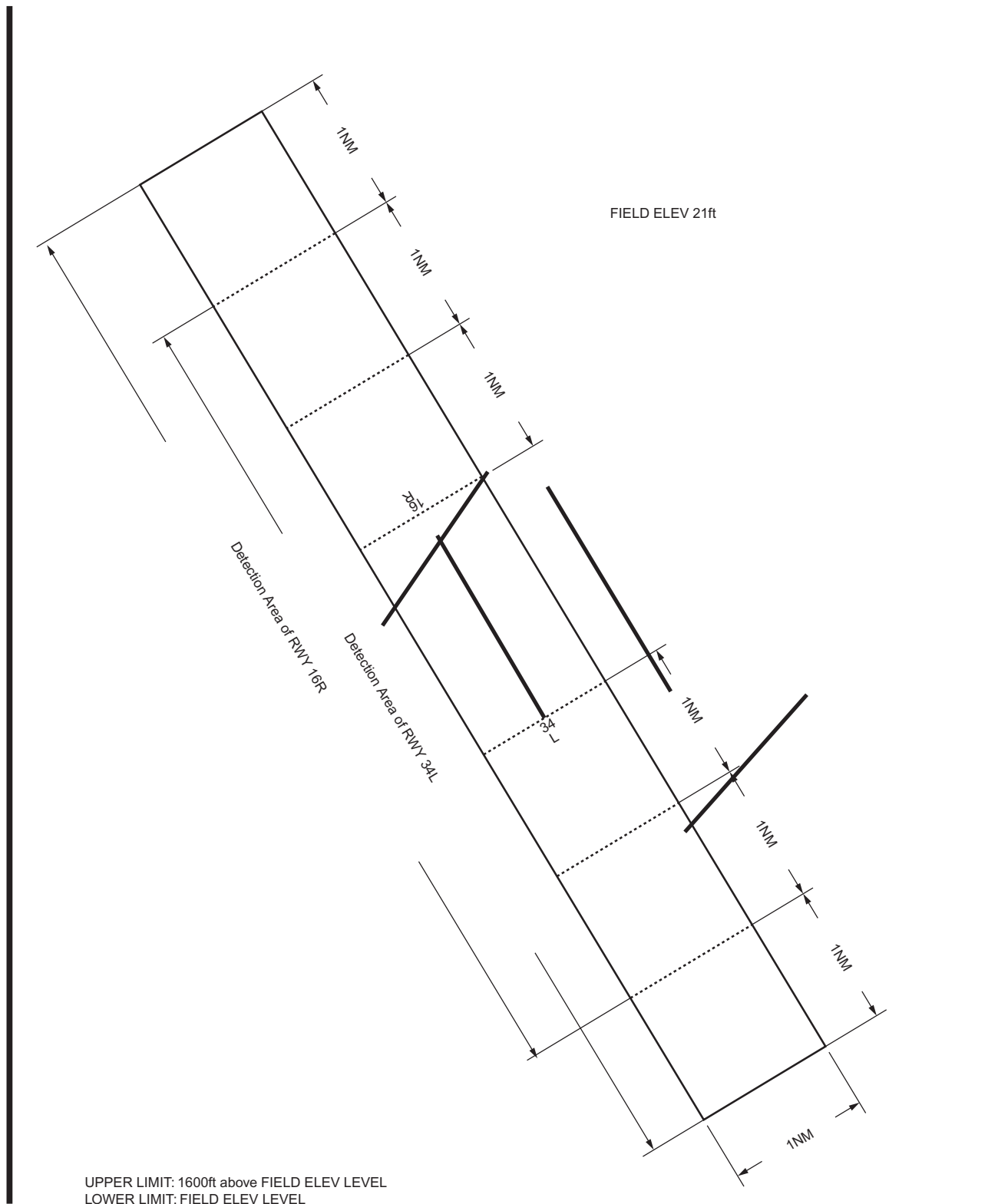



Airspace for the advisory service concerning low level wind shear (RWY04/22)

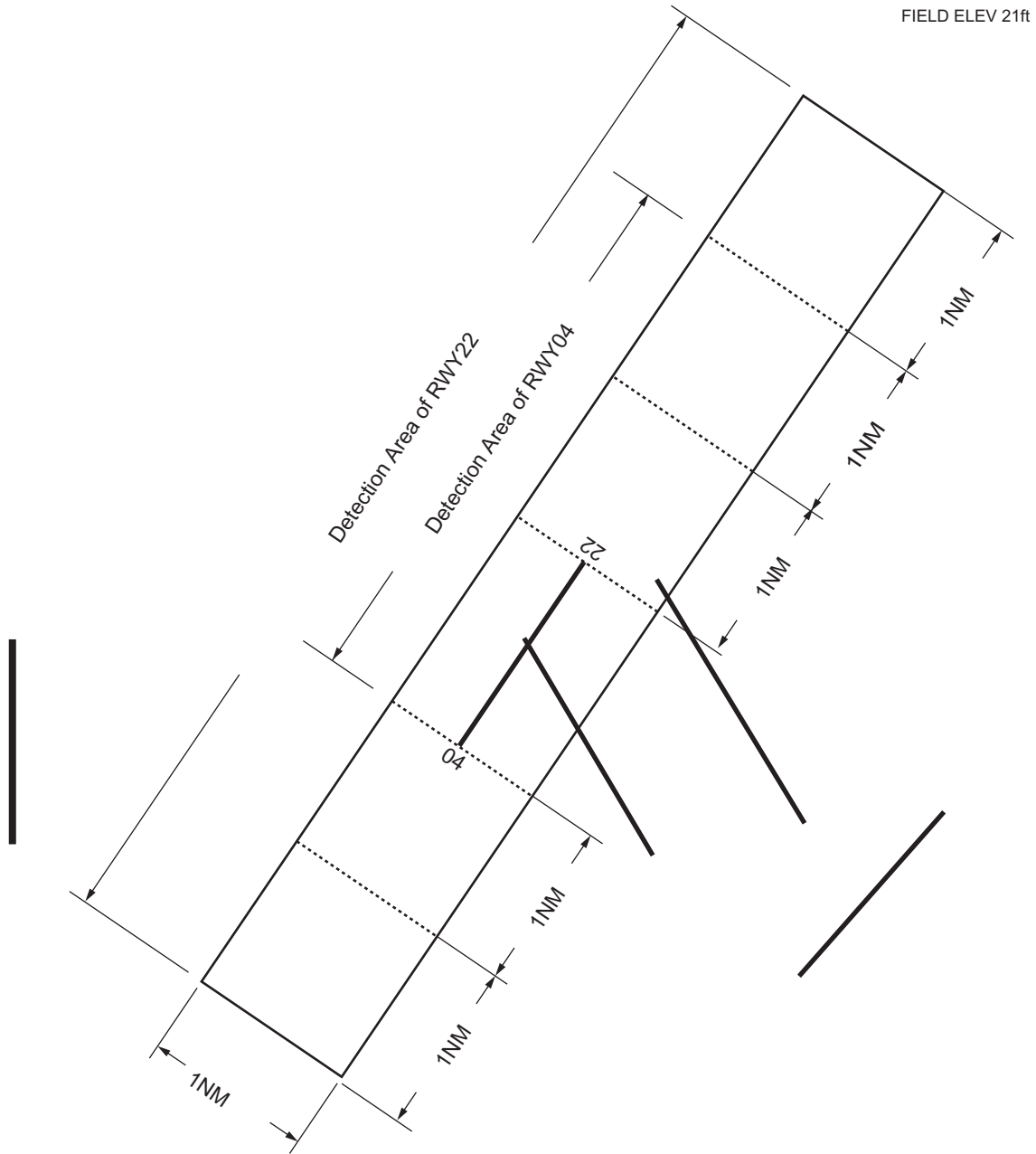

UPPER LIMIT: 1600ft above FIELD ELEV LEVEL  
LOWER LIMIT: FIELD ELEV LEVEL

### Airspace for the advisory service concerning low level wind shear (RWY05/23)

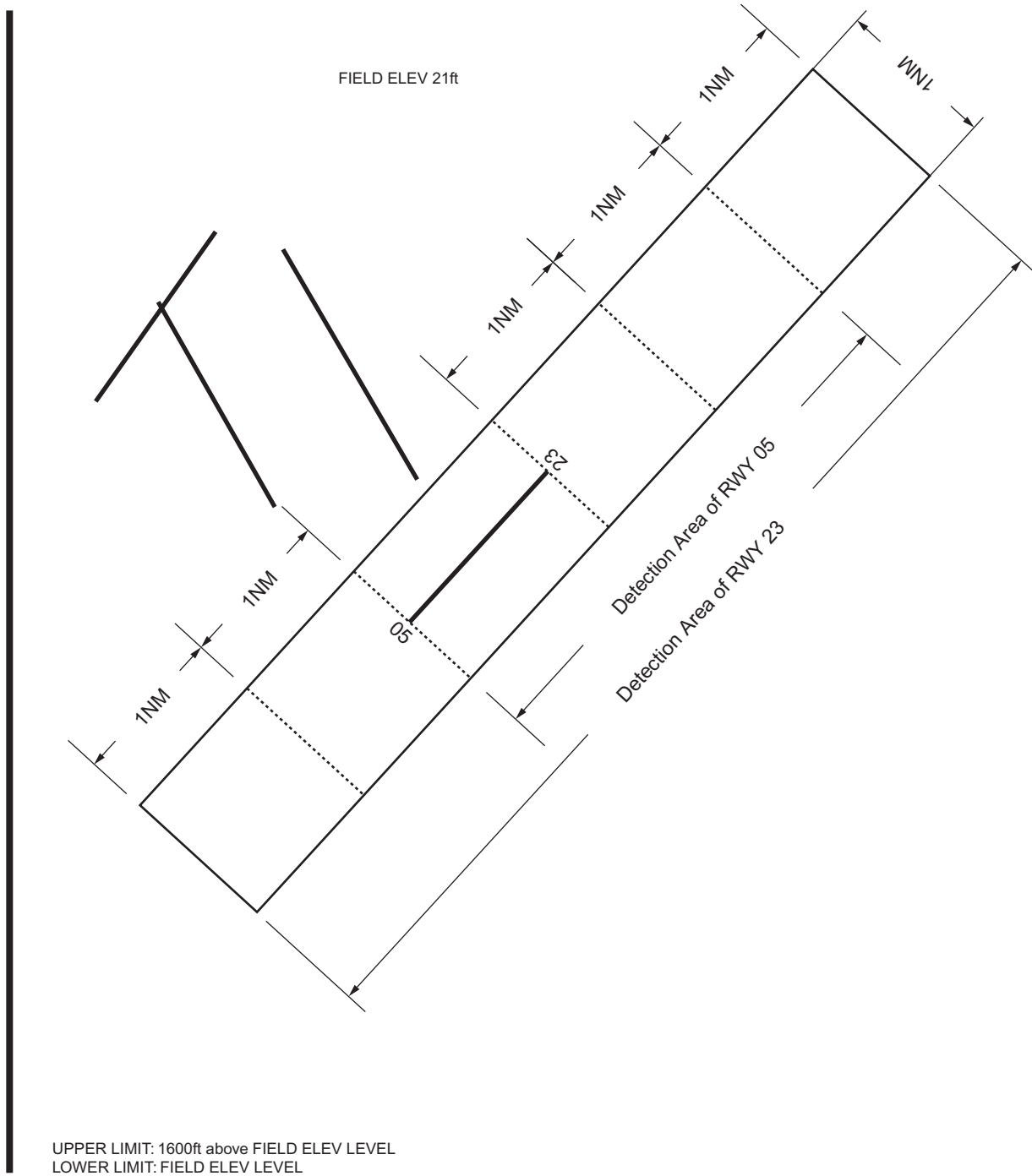

## RJTT AD 2.12 RUNWAY PHYSICAL CHARACTERISTICS

Designations RWY NR	TRUE BRG	Dimensions of RWY(M)	Strength(PCN) and surface of RWY	THR coordinates THR geoid undulation	THR elevation and highest elevation of TDZ of precision APP RWY
1	2	3	4	5	6
16L	149.88°	3360×60	PCN 95/F/B/X/T Asphalt Concrete	353357.23N 1394711.59E 117.7FT (Displaced THR) 353346.27N 1394719.34E 117.8FT	THR ELEV : 21.8FT  (Displaced THR) THR ELEV : 19.2FT TDZ ELEV : 19.2FT
34R	329.88°	3360×60	PCN 95/F/B/X/T Asphalt Concrete	353222.90N 1394818.49E 117.1FT (Displaced THR) 353233.02N 1394811.34E 117.2FT	THR ELEV : 27.8FT  (Displaced THR) THR ELEV : 19.7FT TDZ ELEV : 21.0FT
16R	149.88°	3000×60	PCN85F/B/X/T Asphalt Concrete	353335.95N 1394608.64E 117.9FT (Displaced THR) 353322.47N 1394618.19E 117.9FT	THR ELEV : 20.5FT  (Displaced THR) THR ELEV : 16.4FT TDZ ELEV : 16.4FT
34L	329.88°	3000×60	PCN 85/F/B/X/T Asphalt Concrete	353211.76N 1394708.41E 117.3FT	THR ELEV : 18.2FT TDZ ELEV :18.4FT
04	035.01°	2500×60	PCN 85/F/B/X/T Asphalt Concrete	353256.47N 1394540.60E 117.8FT	THR ELEV : 19.0FT TDZ ELEV :19.3FT
22	215.01°	2500×60	PCN 85/F/B/X/T Asphalt Concrete	353402.88N 1394637.61E 117.9FT	THR ELEV : 35.0FT TDZ ELEV :35.0FT
05	042.56°	2500×60	PCN 102/F/B/X/T* Asphalt Concrete	353126.41N 1394812.47E 116.9FT	THR ELEV : 45.5FT TDZ ELEV :45.5FT
23	222.56°	2500×60	PCN 102/F/B/X/T* Asphalt Concrete	353226.15N 1394919.61E 116.9FT	THR ELEV : 54.7FT TDZ ELEV :54.7FT

Slope of RWY	Strip Dimensions(M)	RESA(Overrun) Dimensions(M)	Arresting System	Remarks
7	10	11	12	14
See below figure	3480×300	150×300		RWY grooving: RWY 16L/34R 3360mx40m RWY 16R/34L 3000mx40m RWY 04/22 2500mx40m RWY 05/23 2500mx40m  *REF AD2.23.7
	3480×300	240×300		
	3120×300	40x(MNM:255 MAX:300)**	EMAS(84.5mx62.8m) *See RJTT AD2.23.8	CAUTION : THR of RWY 16L is displaced by 390m inward. In case of landing, the usable length of RWY 16L is 2,970m. In case of take-off, the usable length of RWY 16L is 3,360m.
	3120×300	240×300		THR of RWY 34R is displaced by 360m inward. In case of landing, the usable length of RWY 34R is 3,000m. In case of take-off, the usable length of RWY 34R is 3,360m.
	2620×300	186x(MNM:210 MAX:300)**		
	2620×300	240×300		
	2620×300	240×300		THR of RWY 16R is displaced by 480m inward. In case of landing, the usable length of RWY 16R is 2,520m. In case of take-off, the usable length of RWY 16R is 3,000m.
	2620×300	240×300 **For detail, ask airport administrator		Usable length of RWY 34L is 3,000m for both landing and take-off.

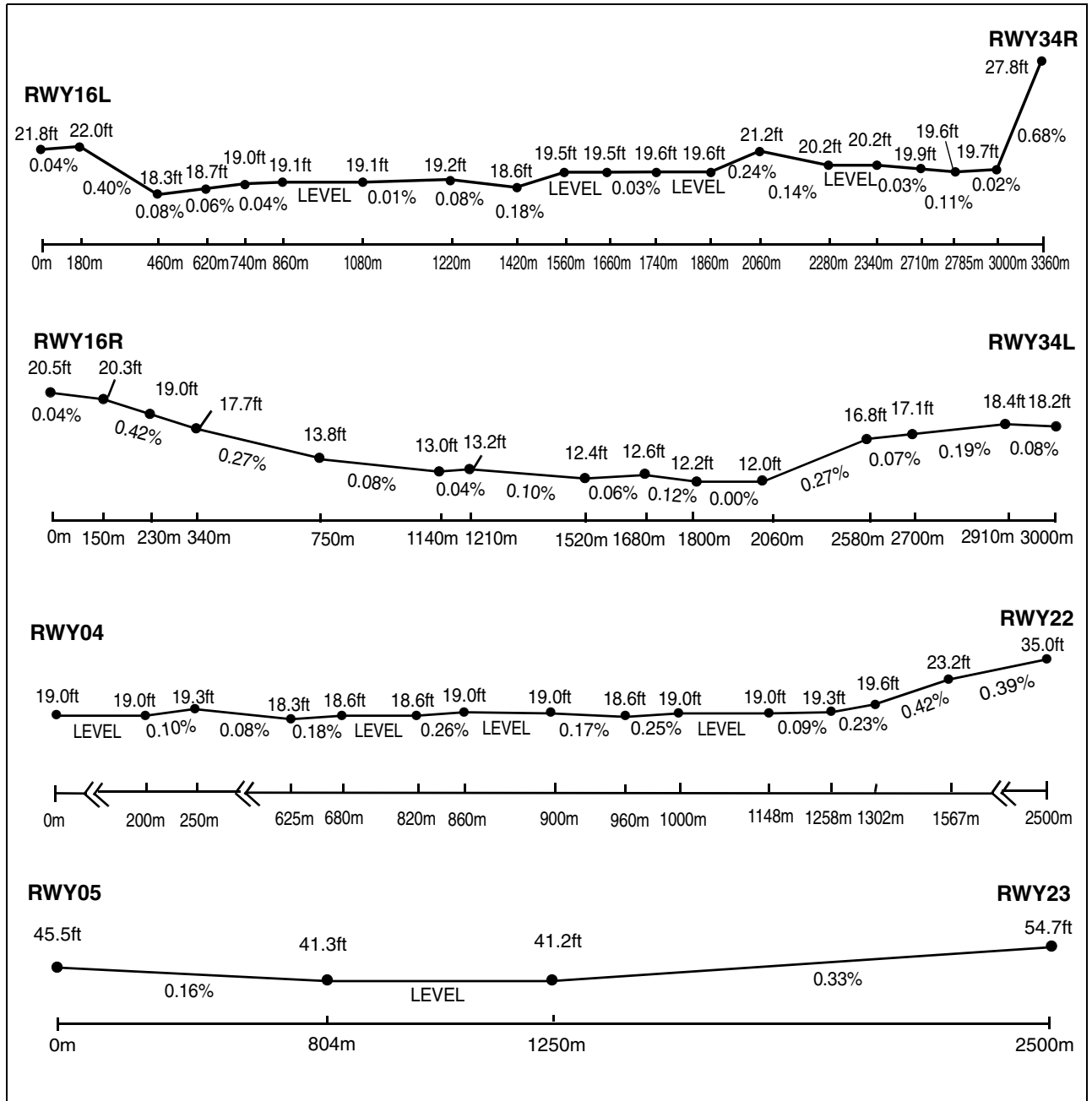

**RJTT AD 2.13 DECLARED DISTANCES**

RWY Designator	TORA (m)	TODA (m)	ASDA (m)	LDA (m)	Remarks
1	2	3	4	5	6
16L 34R	3360 3360	3360 3360	3360 3360	2970 3000	Nil Nil
16R 34L	3000 3000	3000 3000	3000 3000	2520 3000	Nil Nil
04 22	2500 2500	2500 2500	2500 2500	2500 2500	Nil Nil
05 23	2500 2500	2500 2500	2500 2500	- 2500	Not usable for LDG Nil

## RJTT AD 2.14 APPROACH AND RUNWAY LIGHTING

RWY Designator	APCH LGT type LEN INTST	RTHL Color WBAR	PAPI (VASIS) Angle DIST FM THR MEHT	RTZL LEN	RCLL LEN Spacing Color INTST	REDL LEN Spacing Color INTST	RENL Color WBAR	STWL LEN Color
1	2	3	4	5	6	7	8	9
16L	PALS 900M LIH	Green Green	PAPI 3.0°/LEFT 412M 65FT	900M	3360M 15M Coded color (White/Red) LIH	3360M 30M Coded color (White/Yellow/Red) LIH	Red	Nil (*1)
34R	PALS (CAT III) 900M LIH	Green Green	PAPI 3.0°/RIGHT 416M 66FT	900M	3360M 15M Coded color (White/Red) LIH	3360M 30M Coded color (White/Yellow/Red) LIH	Red	Nil (*1)
16R	PALS 900M LIH	Green Green	PAPI 3.0°/LEFT 434M 65FT	900M	3000M 30M Coded color (White/Red) LIH	3000M 60M Coded color (White/Yellow/Red) LIH	Red	Nil (*1)
34L	PALS (CAT I) 900M LIH	Green Green	PAPI 3.0°/LEFT 449M 66FT	900M	3000M 30M Coded color (White/Red) LIH	3000M 60M Coded color (White/Yellow) LIH	Red	Nil (*1)
04	-	Green -	PAPI(*2) 3.0°/LEFT 369M 61FT	-	2500M 30M Coded color (White/Red) LIH	2500M 60M Coded color (White/Yellow) LIH	Red	Nil (*1)
22	PALS (CAT I) 900M LIH	Green Green	PAPI 3.0°/LEFT 438M 63FT	900M	2500M 30M Coded color (White/Red) LIH	2500M 60M Coded color (White/Yellow) LIH	Red	Nil (*1)
05	-	Green -	-	-	2500M 30M Coded color (White/Red) LIH	2500M 30M Coded color (White/Yellow) LIH	Red	Nil (*1)
23	PALS (CAT I) 870M LIH	Green Green	PAPI 3.0°/LEFT 452M 66FT	900M	2500M 30M Coded color (White/Red) LIH	2500M 30M Coded color (White/Yellow) LIH	Red	Nil (*1)
Remarks								
10								
Overrun area edge LGT(LEN:60M(RWY16L,34R,34L,04,22, 05, 23) 77M(RWY16R), Color:Red) (*1) CGL for RWY 16L APCH guidance LGT for RWY16L,16R RWY THR ID LGT for RWY04, RWY22 and RWY16L THR(Color:White) Rapid exit taxiway indicator lights prior to exit to TWY C10, D3 and D5(Color:Yellow) Usable area of PAPI for RWY04 is within 2.4NM FM RWY04 THR(*2)								

**RJTT AD 2.15 OTHER LIGHTING, SECONDARY POWER SUPPLY**

1	ABN/IBN location, characteristics and hours of operation	ABN: 353238N/1394557E, White/Green EV4.3sec, HO
2	LDI location and LGT Anemometer location and LGT	LDI:Nil Anemometer: RWY16L: 358m from RWY16L THR, LGTD RWY34R: 710m from RWY34R THR, LGTD RWY16R: 226m from RWY16R THR, LGTD RWY34L: 270m from RWY34L THR, LGTD RWY04: 273m from RWY04 THR, LGTD RWY22: 400m from RWY22 THR, LGTD RWY05: 381m from RWY05 THR, LGTD RWY23: 319m from RWY23 THR, LGTD
3	TWY edge and center line lighting	TWY edge LGT: Blue TWY CL LGT: ALTN Green/Yellow FM RWY leaving report point, other Green
4	Secondary power supply / switch-over time	Within 1 sec: PALS(RWY34R), PAPI(RWY16L/34R), RCLL(RWY16L/34R), RTZL(RWY34R), RENL(RWY16L/34R), RTHL(RWY16L/34R), WBAR(RWY16L/34R), Overrun area edge LGT(RWY16L/34R), Stop Bar LGT  Within 15 sec : PALS(RWY16L/16R/34L/22/23), CGL(RWY16L), PAPI(RWY16R/34L/04/22/23), REDL(RWY16L/34R/16R/34L/04/22/05/23), RCLL(RWY16R/34L/04/22/05/23), RTZL(RWY16L/16R/34L/22/23), RENL(RWY16R/34L/04/22/05/23), RTHL(RWY16R/34L/04/22/05/23), WBAR(RWY16R/34L/22/23), RWY THR ID LGT(RWY16L/04/22), Overrun area edge LGT(RWY16R/34L/04/22/05/23), RWY guard LGT, ABN, TWY edge LGT, TWY CL LGT, Intermediate Holding Position Light, Rapid exit taxiway indicator lights, Taxiing guidance sign, WDI LGT, Variable Message Signs
5	Remarks	WDI LGT

**RJTT AD 2.16 HELICOPTER LANDING AREA**

Nil
-----

**RJTT AD 2.17 ATS AIRSPACE**

Designation and lateral limits		Vertical limits (ft)	Airspace classification	ATS unit call sign Language	Remarks
1		2	3	4	6
TOKYO CTR	Area defined as follows. Area within a radius of 5nm of TOKYO INTERNATIONAL ARP (35°33'N/139°47'E).	3 000 or below (900)	D	TOKYO TOWER En	
TOKYO PCA	SEE RJTT ATTACHED CHART		C		
TOKYO ACA	SEE RJTT ATTACHED CHART		E		
TOKYO TCA	SEE RJTT ATTACHED CHART		E		

東京特別管制区  
Tokyo Positive Control Area

NAME	LATERAL LIMITS	UPPER LIMIT (AMSL) ----- LOWER LIMIT (AMSL) M(ft)	UNIT PROVIDING SERVICE	REMARKS
1	2	3	4	5
Tokyo	下図に示される区域 The area shown below  (1) 東京第一特別管制区 Tokyo NR1 Positive control Area  (2) 東京第二特別管制区 Tokyo NR2 Positive control Area		Primary Tokyo APP 119.1MHz 119.7MHz  Secondary Tokyo Tower 118.1MHz 124.35MHz	当該空域を飛行しようとする航空機は東京アプローチ又はタワーに連絡し、コールサイン、現在位置、高度及び意図を通報し指示を受けなければならない。なお、東京第一特別管制区にあっては24時間、東京第二特別管制区にあっては0600UTCから1000UTCの間とする。 Pilot requiring transit of Tokyo NR1/NR2 Positive Control Area must call Tokyo Approach or Tower prior to the point of entry to provide aircraft identification, position, altitude and intention. This rule is enforced 24 hours a day for Tokyo NR1 Positive Control Area and between 0600UTC and 1000UTC for Tokyo NR2 Positive Control Area.

Tokyo Positive Control Area

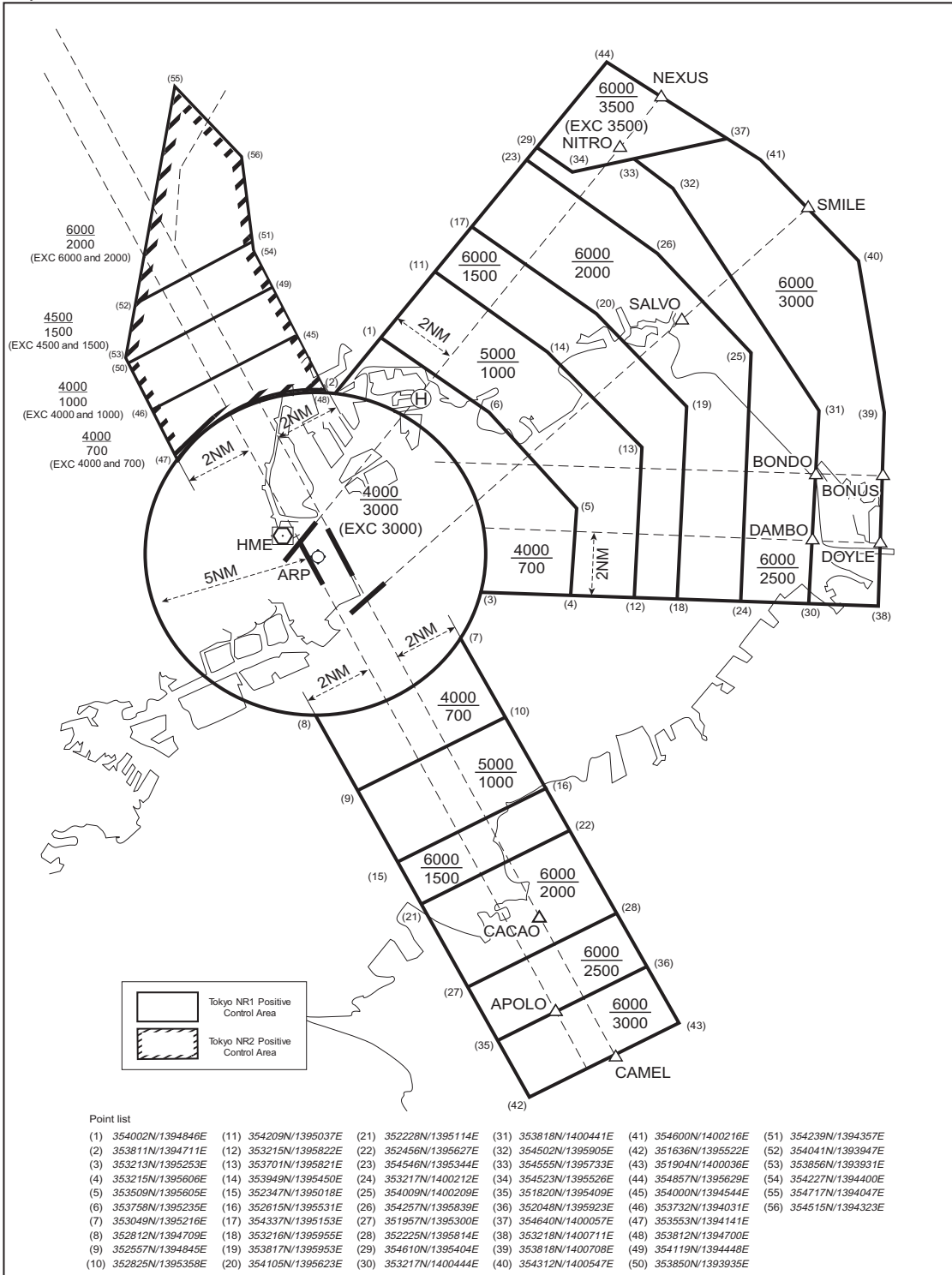



東京進入管制区  
Tokyo Approach Control Area

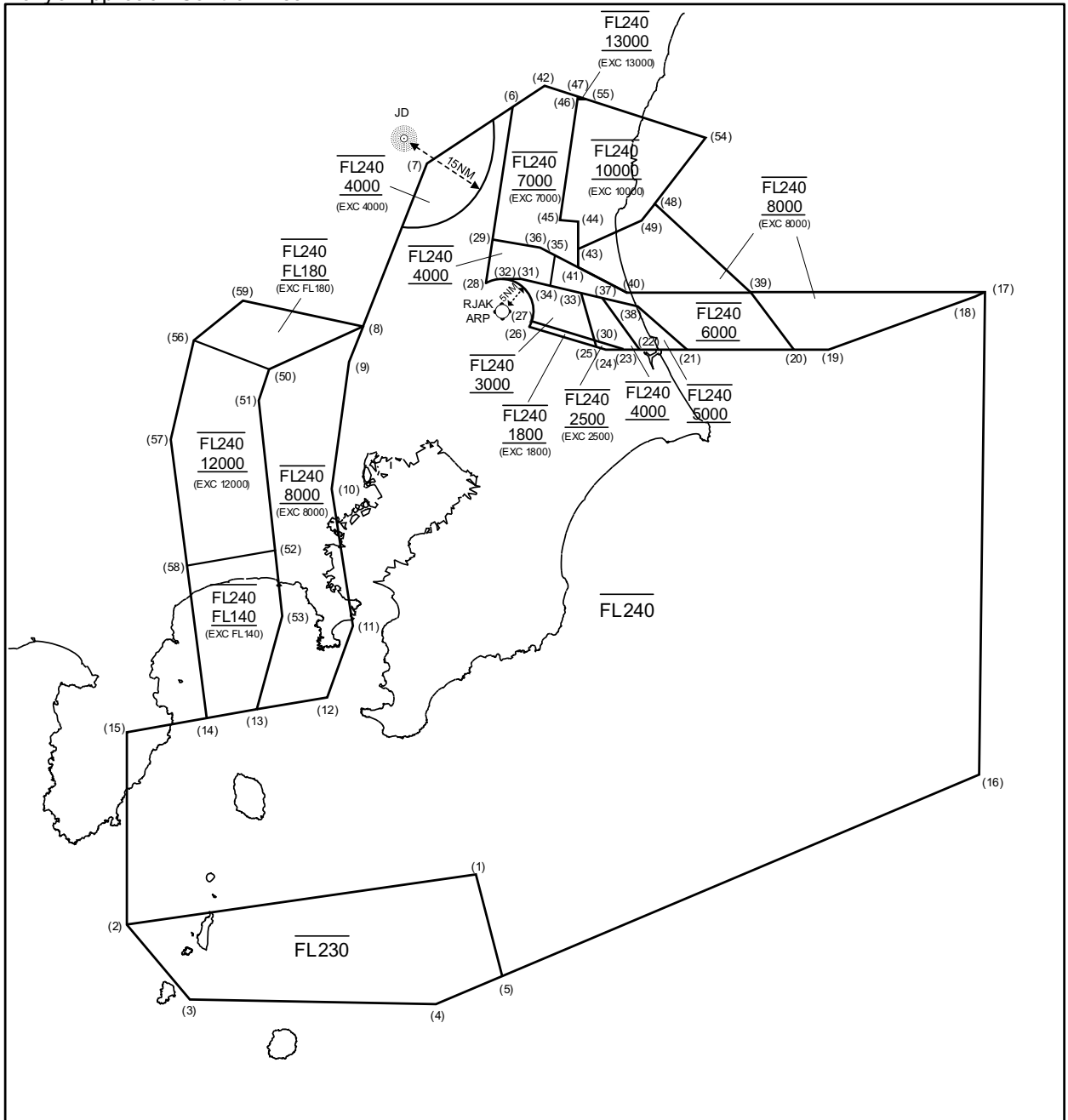

Point list

(1) 343224N/1400724E	(18) 360419N/1414409E	(35) 361053N/1402147E	(52) 352343N/1392749E
(2) 342337N/1390033E	(19) 355600N/1411534E	(36) 361204N/1401853E	(53) 351301N/1392926E
(3) 341153N/1391255E	(20) 355600N/1410841E	(37) 360407N/1403112E	(54) 362938N/1405126E
(4) 341141N/1395954E	(21) 355600N/1404746E	(38) 360250N/1403803E	(55) 363540N/1402812E
(5) 341614N/1401235E	(22) 355600N/1403828E	(39) 360503N/1410017E	(56) 355626N/1390939E
(6) 363429N/1401317E	(23) 355600N/1403535E	(40) 360500N/1403600E	(57) 354316N/1390433E
(7) 362515N/1395633E	(24) 355600N/1403154E	(41) 360858N/1402626E	(58) 352134N/1390812E
(8) 355918N/1394424E	(25) 355626N/1403002E	(42) 363752N/1401937E	(59) 360223N/1391842E
(9) 355339N/1394146E	(26) 355930N/1401651E	(43) 361152N/1402623E	
(10) 353325N/1393840E	(27) 360023N/1401723E	(44) 361619N/1402619E	
(11) 351136N/1394310E	(28) 360623N/1400824E	(45) 361628N/1402245E	
(12) 350019N/1393818E	(29) 361321N/1400930E	(46) 363547N/1402606E	
(13) 345811N/1392443E	(30) 355732N/1402939E	(47) 363611N/1402610E	
(14) 345614N/1391225E	(31) 360705N/1401514E	(48) 361913N/1404125E	
(15) 345412N/1385949E	(32) 360705N/1401134E	(49) 361630N/1403849E	
(16) 344816N/1414417E	(33) 360453N/1402703E	(50) 355218N/1392608E	
(17) 360500N/1414604E	(34) 360602N/1402056E	(51) 354715N/1392411E	

東京ターミナルコントロールエリア  
Tokyo Terminal Control Area

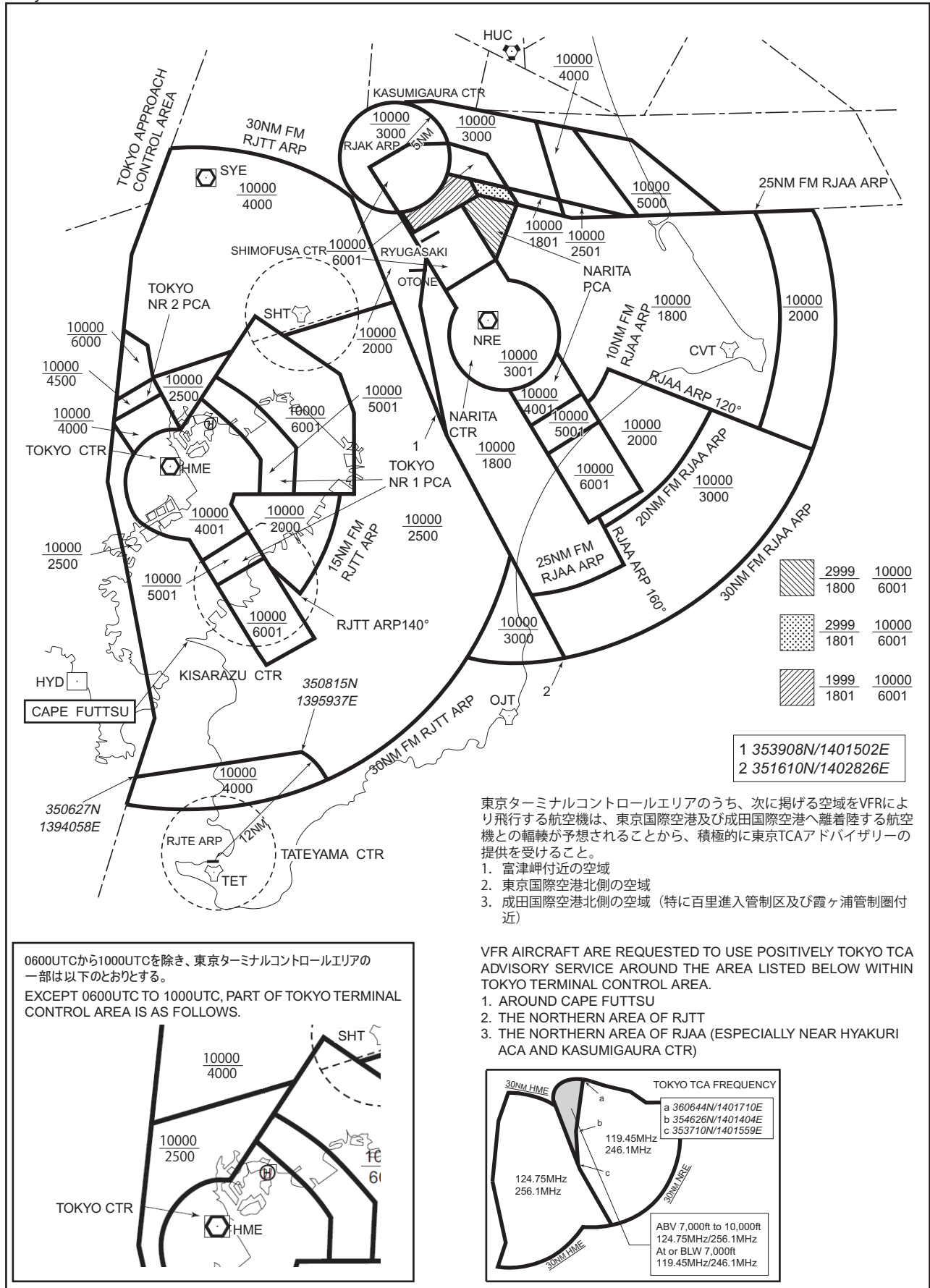

東京ターミナルコントロールエリアのうち、次に掲げる空域をVFRにより飛行する航空機は、東京国際空港及び成田国際空港へ離着陸する航空機との輻輳が予想されることから、積極的に東京TCAアドバイザーの提供を受けること。  
 1. 富津岬付近の空域  
 2. 東京国際空港北側の空域  
 3. 成田国際空港北側の空域（特に百里進入管制区及び霞ヶ浦管制圏付近）

0600UTCから1000UTCを除き、東京ターミナルコントロールエリアの一部は以下のとおりとする。  
 EXCEPT 0600UTC TO 1000UTC, PART OF TOKYO TERMINAL CONTROL AREA IS AS FOLLOWS.

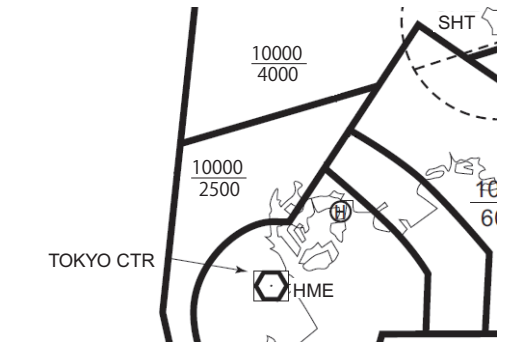

VFR AIRCRAFT ARE REQUESTED TO USE POSITIVELY TOKYO TCA ADVISORY SERVICE AROUND THE AREA LISTED BELOW WITHIN TOKYO TERMINAL CONTROL AREA.  
 1. AROUND CAPE FUTTSU  
 2. THE NORTHERN AREA OF RJTT  
 3. THE NORTHERN AREA OF RJAA (ESPECIALLY NEAR HYAKURI ACA AND KASUMIGAURA CTR)

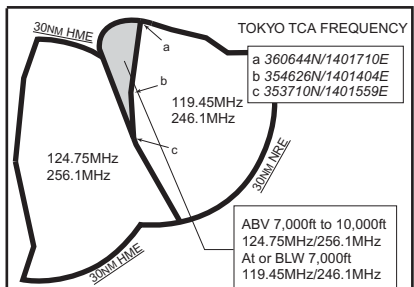

RJTT AD 2.18 ATS COMMUNICATION FACILITIES

Service designation	Call sign	Frequency		Hours of operation	Remarks
1	2	3		4	5
APP	Tokyo Approach	119.1MHz(1) 119.4MHz 119.65MHz 119.7MHz 125.4MHz 232.2MHz 261.2MHz 121.5MHz(E) 243.0MHz(E)	121.275MHz 124.4MHz 125.2MHz 125.8MHz 127.7MHz 225.65MHz	H24	(1)Primary
ASR	Tokyo Radar	124.0MHz 126.5MHz 236.8MHz 261.2MHz 295.9MHz 121.5MHz(E) 243.0MHz(E) 120.2MHz	119.025MHz 120.9MHz 123.6MHz 125.1MHz 283.4MHz	H24	
DEP	Tokyo Departure	126.0MHz(1) 120.8MHz 127.5MHz 127.6MHz 121.5MHz(E) 243.0MHz(E) 124.2MHz 119.6MHz 120.6MHz 125.525MHz		H24	
TCA	Tokyo TCA	124.75MHz(1) 119.7MHz 256.1MHz  119.45MHz 246.1MHz		2300 - 1200  2300 - 1030	
TWR	Tokyo Tower	118.1MHz(1) 118.575MHz 118.725MHz 124.35MHz 118.8MHz 126.2MHz 236.8MHz 121.5MHz(E) 243.0MHz(E)		H24	
GND	Tokyo Ground	118.225MHz 121.625MHz 121.7MHz 121.975MHz 122.075MHz		H24	See RJTT AD2.20.1.2 (14) "GROUND CONTROL Frequency"
DLVRY	Tokyo Delivery	121.825MHz(1) 121.875MHz		H24	
ATIS	Tokyo INTL Airport	128.8MHz		H24	

## RJTT AD 2.19 RADIO NAVIGATION AND LANDING AIDS

Type of aid	ID	Frequency	Hours of operation	Position of transmitting antenna coordinates	Elevation of DME transmitting antenna	Remarks
1	2	3	4	5	6	7
VOR	HME	112.2MHz	H24	353344.34N/ 1394540.14E		VOR Unusable: 1) 230° -240° beyond 15nm BLW 8000ft. 2) 240° -260° beyond 10nm BLW 8000ft.
DME	HME	1020MHz (CH-59X)	H24	353344.34N/ 1394540.14E	63ft	VOR/DME Unusable: 1) 210° -230° beyond 20nm BLW 3000ft. 2) 330° -340° beyond 30nm BLW 3000ft. 3) 340° -020° beyond 20nm BLW 3000ft.
ILS-LOC 16L	IOC	111.95MHz	H24	353217.43N/ 1394822.37E		LOC: 195m(640ft) away FM RWY34R THR, BRG(MAG) 157.41°.
ILS-GP 16L	-	330.95MHz	H24	353335.57N/ 1394721.45E		GP: 312m(1024ft) inside FM RWY16L Displaced THR, 120m(394ft) SW of RCL. HGT of ILS Ref datum 16.3m(53ft). GP angle 3.0°.
ILS-DME 16L	IOC	1143MHz (CH-56Y)	H24	353335.08N/ 1394721.61E	34ft	DME: 320m(1050ft) inside FM RWY16L Displaced THR, 131.5m(431ft) SW of RCL.
ILS-LOC 34R	ITC	108.9MHz	H24	353403.81N/ 1394706.89E		LOC: (ITC) 235m(771ft) away FM RWY16L THR, BRG (MAG) 337°.
ILS-GP 34R	-	329.3MHz	H24	353243.92N/ 1394809.36E		GP: 316m(1037ft) inside FM RWY34R Displaced THR, 126m(413ft) NE of RCL. HGT of ILS Ref datum 16.5m(54ft). GP angle 3.0°.
ILS-DME 34R	ITC	987MHz (CH-26X)	H24	353244.02N/ 1394809.72E	35ft	DME: 314m(1030ft) inside FM RWY34R Displaced THR, 135m(443ft) NE of RCL.
IM 34R	-	75MHz	H24	353220.45N/ 1394820.26E		IM: 446m(1463ft) away FM RWY34R Displaced THR.
ILS-LOC 16R	ITA	111.55MHz	H24	353206.29N/ 1394712.30E		LOC: 195m(640ft) away FM RWY34L THR, BRG(MAG) 157.41°.
ILS-GP 16R	-	332.75MHz	H24	353315.14N/ 1394628.93E		GP: 326m(1070ft) inside FM RWY16R Displaced THR, 120m(394ft) NE of RCL. HGT of ILS Ref datum 16.3m(53ft). GP angle 3.0°.
ILS-DME 16R	ITA	1139MHz (CH-52Y)	H24	353315.97N/ 1394629.22E	31ft	DME: 334m(1096ft) inside FM RWY16L Displaced THR, 125m(410ft) NE of RCL.

Type of aid	ID	Frequency	Hours of operation	Position of transmitting antenna coordinates	Elevation of DME transmitting antenna	Remarks
1	2	3	4	5	6	7
ILS-LOC 34L	IHA	111.7MHz	H24	353343.81N/ 1394603.06E		LOC: (IHA) 280m(919ft) away FM RWY 16R THR, BRG(MAG)337°.
ILS-GP 34L	-	333.5MHz	H24	353223.19N/ 1394705.78E		GP: 338m(1109ft) inside FM RWY34L THR, 120m(394ft) NE of RCL. HGT of ILS Ref datum 16.5m (54ft). GP angle 3.0°.
ILS-DME 34L	IHA	1015MHz (CH-54X)	H24	353223.33N/ 1394706.14E	43ft	DME: 338m(1109ft) inside FM RWY34L THR, 130m (427ft) NE of RCL. DME Unusable: beyond 15° E side of LOC course.
ILS-LOC 22	IAD	108.1MHz	H24	353248.36N/ 1394533.62E		LOC: (IAD)305m (1001ft) away FM RWY04 THR, BRG(MAG) 222°.
ILS-GP 22	-	334.7MHz	H24	353351.52N/ 1394633.91E		GP: 339m(1112ft) inside FM RWY22 THR, 125m (410ft) S of RCL. HGT of ILS Ref datum 16.5m(54ft). GP angle 3.0°.
ILS-DME 22	IAD	979MHz (CH-18X)	H24	353351.23N/ 1394633.96E	44ft	DME: 346.4m(1137ft) inside FM RWY22 THR, 130.9m(429ft) S of RCL.
LDA-LOC 22	IKL	110.1MHz	H24	353613.77N/ 1394908.33E		LOC: (IKL) 5481m(17983ft) outside FM RWY22, 788m(2585ft) S of RCL, BRG(MAG) 277°.
LDA-DME 22	IKL	999MHz (CH-38X)	H24	353612.96N/ 1394908.33E	122ft	DME: 5460m(17914ft) outside FM RWY22, 803m(2635ft) S of RCL.
ILS-LOC 23	ITD	110.5MHz	H24	353151.24N/ 1394835.14E		LOC: (ITD) 950m(3117ft) inside FM RWY05 THR, 97m(318ft) N of RCL. LOC off-set angle 2.0°, BRG(MAG)232°.
ILS-GP 23	-	329.6MHz	H24	353220.86N/ 1394906.93E		GP: 336m(1102ft) inside FM RWY23 THR, 125m(410ft) N of RCL. HGT of ILS Ref datum 16.5m (54ft). GP angle 3.0°.
ILS-DME 23	ITD	1003MHz (CH-42X)	H24	353221.08N/ 1394906.64E	67ft	DME: 336m(1102ft) inside FM RWY23 THR, 135m (443ft) NE of RCL.
LDA-LOC 23	ITL	108.5MHz	H24	353410.37N/ 1394656.13E		LOC: (ITL) 79m(259ft) inside FM RWY23, 4834m(15860ft) N of RCL, BRG(MAG) 277°.
LDA-DME 23	ITL	983MHz (CH-22X)	H24	353411.11N/ 1394656.12E	34ft	DME: 62m(203ft) inside FM RWY23, 4849m(15910ft) N of RCL.
MSAS		1575.42MHz	H24			Transmitting antennas are satellite based.

ILS for RWY 34L

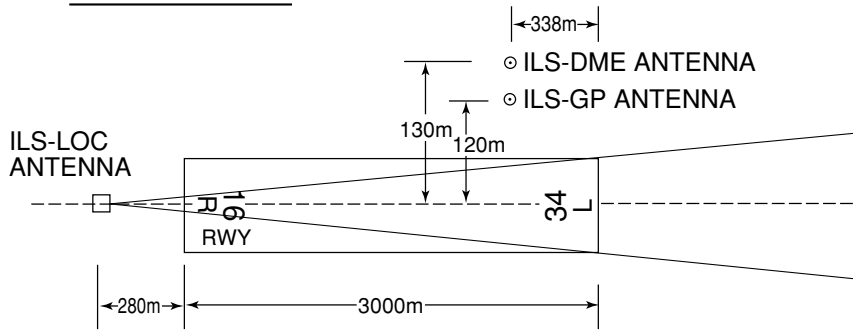

- REMARKS : 1. LOC beam BRG (MAG) 337°  
 2. HGT of ILS REF datum 16.5m(54ft)  
 3. GP Angle 3.0°  
 4. ELEV of ILS-DME 13.0m(43ft)

ILS for RWY 22

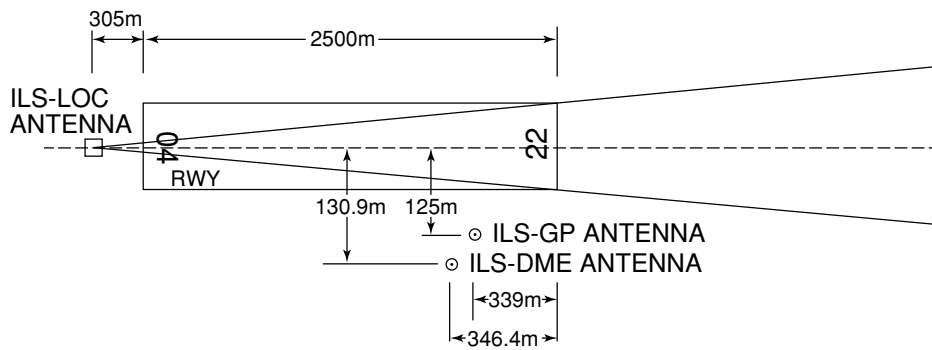

- REMARKS : 1. LOC beam BRG(MAG) 222°  
 2. HGT of ILS REF datum 16.5m(54ft)  
 3. GP Angle 3.0°  
 4. ELEV of ILS-DME 13.5m(44ft)

ILS for RWY 34R

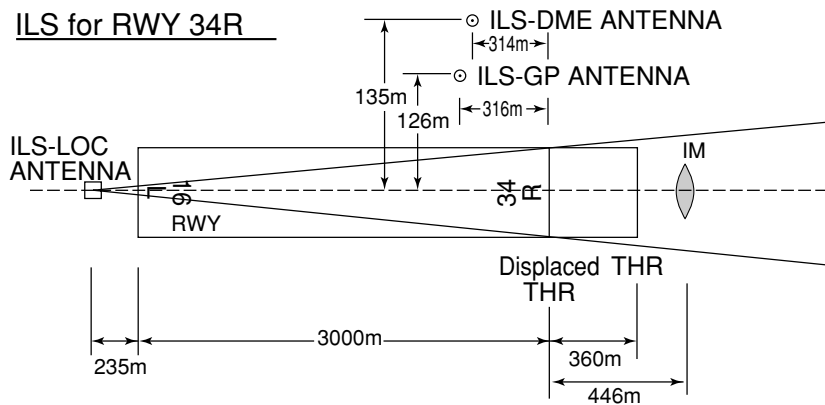

- REMARKS : 1. LOC BEAM BRG(MAG) 337°  
 2. HGT of ILS REF datum 16.5m(54ft)  
 3. GP Angle 3.0°  
 4. ELEV of ILS-DME 10.6m(35ft)

LDA for RWY 22

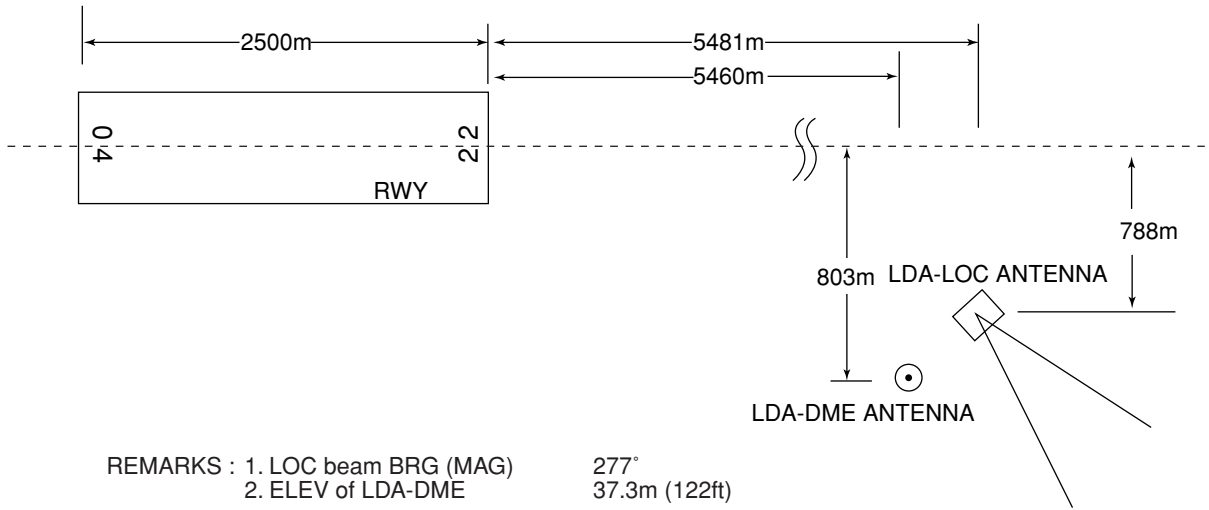

ILS for RWY 23

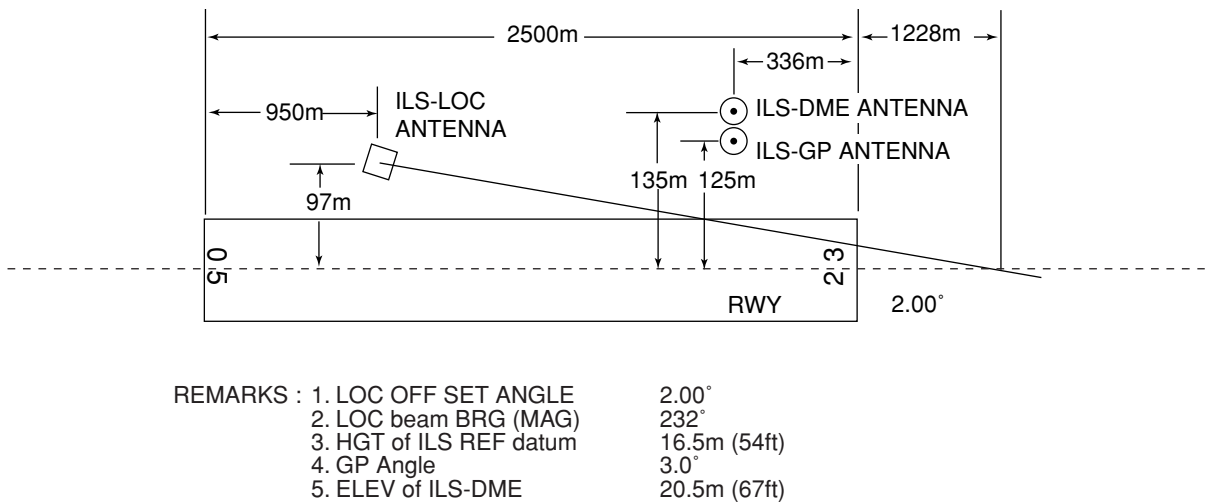

LDA for RWY 23

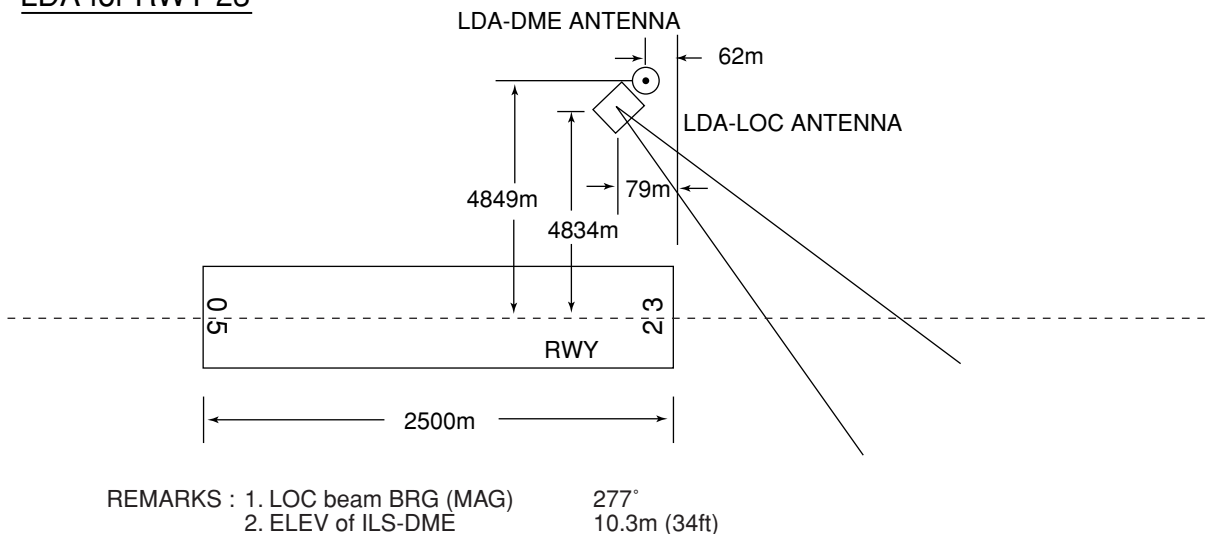

ILS for RWY 16R

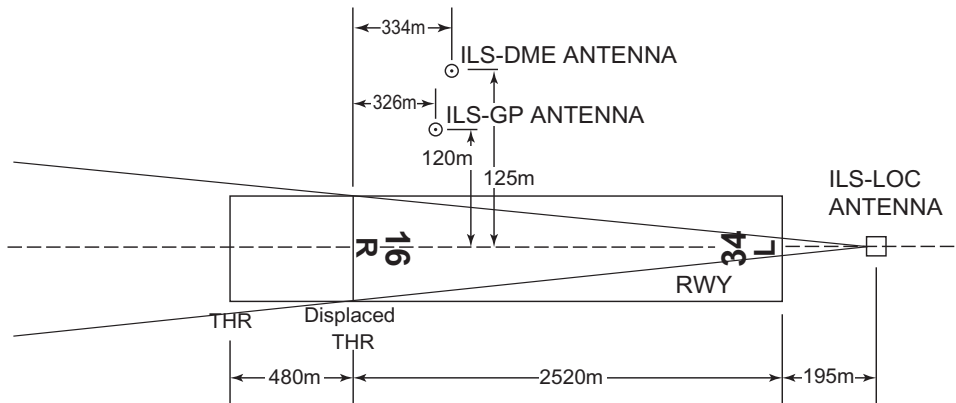

REMARKS : 1. LOC beam BRG (MAG) 157.41°  
 2. HGT of ILS REF datum 16.3m(53ft)  
 3. GP Angle 3.0°  
 4. ELEV of ILS-DME 9.4m(31ft)

ILS for RWY 16L

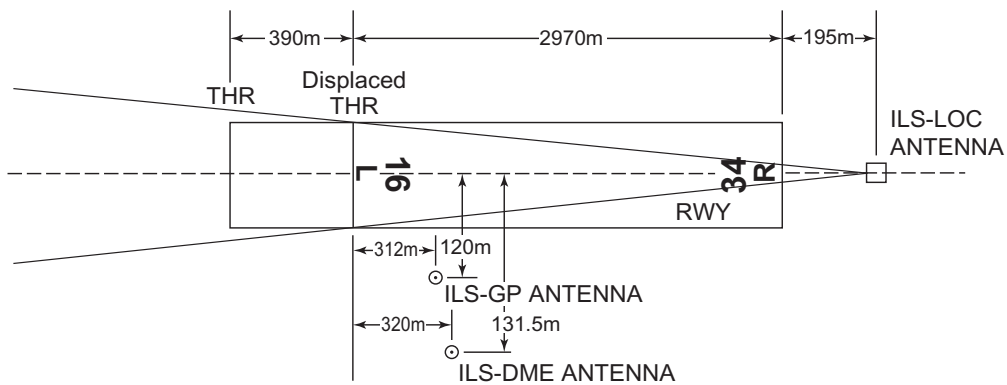

REMARKS : 1. LOC beam BRG (MAG) 157.41°  
 2. HGT of ILS REF datum 16.3m(53ft)  
 3. GP Angle 3.0°  
 4. ELEV of ILS-DME 10.1m(34ft)



**RJTT AD 2.20 LOCAL TRAFFIC REGULATIONS**

1. Airport regulations

1.1 Procedural Speed and Speedy Turn Off Procedure

In order to reduce runway occupancy time with the smooth traffic flow based on safety, arriving aircraft should operate as follows.

(1)Procedural Speed (for IFR)

(a)Unless otherwise instructed by ATC, arriving aircraft should cross each points at the speed listed below.

Approach	Point	Procedural Speed
ILS Z RWY34L LOC Z RWY34L	IHA 10.0DME	180 kt (IAS)
	IHA 5.0DME	160 kt (IAS)
ILS X RWY34L	KAIHO	180 kt (IAS)
	ALLIE	160 kt (IAS)
ILS Z RWY34R LOC Z RWY34R	ITC 10.0DME	180 kt (IAS)
	ITC 5.0DME	160 kt (IAS)
ILS RWY22 LOC RWY22	IAD 10.0DME	180 kt (IAS)
	IAD 5.0DME	160 kt (IAS)
LDA Z RWY22 LDA X RWY22 LDA W RWY22	IKL 8.0DME	180 kt (IAS)
	IKL 3.0DME	160 kt (IAS)
ILS Z RWY23 LOC Z RWY23	ITD 10.0DME	180 kt (IAS)
	ITD 5.0DME	160 kt (IAS)
LDA Z RWY23 LDA X RWY23 LDA W RWY23	ITL 12.0DME	180 kt (IAS)
	ITL 7.0DME	160 kt (IAS)
ILS RWY16R	ITA 10.0DME	180 kt (IAS)
	ITA 5.0DME	160 kt (IAS)
RNAV RWY16R	10.2NM from THR	170 kt (IAS)
ILS RWY16L	IOC 10.0DME	180 kt (IAS)
	IOC 5.0DME	160 kt (IAS)
RNAV RWY16L	9.2NM from THR	170 kt (IAS)

(b)

1)When speed adjustment is made after approach clearance issued, ATC will instruct to comply with Procedural Speed by the phrase as below instead of "RESUME PUBLISHED SPEED (ref. ENR1.6.1.8.7)".

(e.g.) COMPLY WITH PROCEDURAL SPEED.

2)Pilots should advise ATC when unable to comply with Procedural Speed due to an operational or a performance reason.

(e.g.) UNABLE TO COMPLY WITH PROCEDURAL SPEED ([number]KNOTS).

3)Pilots will be informed by ATC when there is no need to comply with Procedural Speed.

(e.g.) PROCEDURAL SPEED ([number]KNOTS) IS NOT REQUIRED.

(e.g.) MAINTAIN PROCEDURAL SPEED OR GREATER.

## (2) Speedy Turn Off Procedure

(a) The exit taxiways, as a rule, from which arriving aircraft should plan to vacate the runway are listed below.

(b) Pilot should vacate the runway for which the nearest side of the arriving spot.

RWY	EXIT TAXIWAY	DISTANCE FROM THRESHOLD (m/ft)	REMARKS
34L	A10	1,500/4,920	for Terminal 1 and Terminal 2*
	A12	2,000/6,560	
	L10	1,320/4,330	for Terminal 3 and "N" Area*
	L12	1,800/5,900	
	L13	2,080/6,820	
16R	A5	1,530/5,020	for Terminal 1 and Terminal 2*
	A2	2,040/6,690	
	L5	1,500/4,920	for Terminal 3 and "N" Area*
34R	C9	1,290/4,230	
	C10	1,670/5,470	
	C11	2,120/6,950	
16L	C7	1,390/4,570	
	C6	1,710/5,640	
	C4	2,000/6,560	
22	B8	1,050/3,440	Except for "N" Area*
	B6	1,530/5,010	
	B4	1,800/5,900	
	B3	2,030/6,660	
	T8	1,050/3,440	for "N" Area*
	T6	1,530/5,010	
	T4	1,800/5,900	
	T3	2,030/6,660	
23	D5	1,500/4,920	
	D3	1,800/5,900	

\*Except for Instructed by ATC when the Aircraft is on the air or on the ground

(c) Pilots should plan which exit taxiway to be used to vacate the runway in approach/landing briefing. Upon landing, pilots should vacate the runway without delay and pass the runway holding position marking on the exit taxiway. It is better, in terms of runway occupancy time, to aim for an exit which can be made, rather than to aim for an earlier one, just to miss it and then to roll slowly to the next.

Note ; The intensity of the taxiway center line lights listed below will be more increased than that of other taxiways to improve the recognition of these exit taxiways.

RWY	TAXIWAY
16L	C4, C6, C7
34R	C10, C11
22	B4
	B6
	T4
	T6
16R	A2, A5, L5
34L	A10, A12
	L12

1.2 Procedures other than 1. and 2. above and information

- (1) Aircraft operations other than scheduled or in emergency  
On use of this airport, aircraft operator is required to obtain the prior permission of the airport administrator.
- (2) A380-800 is prohibited from operating between 2100UTC and 1400UTC.
- (3) When operating A380-800 between 1400UTC and 2100UTC, the aircraft weight restriction is imposed.  
(see RJTT AD2.23.7)
- (4) A380-800 and B747-8 shall equip digital avionics that provide steering commands to maintain an established track during the go-around manoeuvre and they shall be utilized when landing to runway.
- (5) Aircraft without approvals of RNAV1 and RNAV5 is prohibited from operating.
- (6) Preflight call to control tower  
IFR departing aircraft should notify TOKYO DELIVERY of their readiness five minutes prior to starting engines with following items for facilitating ATC service.
  - a. call sign
  - b. spot number
  - c. proposed flight level/altitude and route (only when changed from original Flight Plan)
- (7) Pilot should ensure that they are able to follow the clearance to the take-off position or the take-off clearance without delay to reduce runway occupancy time. Cockpit check should be completed prior to line-up and checks requiring completion on the runway should be kept to a minimum. If unable to do so, notify to Tokyo Tower.
- (8) Pilot should ensure that they are able to follow the instruction for runway crossing without delay. Upon runway crossing, pilot should vacate the runway as soon as possible and pass through the runway holding position marking on the exit taxiway.
- (9) Departure aircraft is required to take off with runway length 2500m except following (a) and (b).
  - (a) Between 2100UTC and 1400UTC : Departure aircraft(\*) for North America, Europe and Turkey.
  - (b) Between 1400UTC and 2100 UTC : Departure specified and allowed in advance(see RJTT AD2.21 NOISE ABATEMENT PROCEDURES 2.Noise Preferential Runways)
 (Note)\*Between 0600UTC and 1000UTC, non-scheduled flight is required to take off with runway length 2500m,even though bound for North America, Europe and Turkey.
- (10) Predetermined Runway depend on the flight direction  
During 2100UTC and 1400UTC, the aircraft will be assigned departure runway depending on the flight direction.

The Airway or Fix filed in Flight Plan (Reference AIC)	Departure Runway		
	North wind operation	South wind operation 1 (RWY22/23 approaches in progress)	South wind operation 2 (RWY16L/R approaches in progress between 0600UTC and 1000UTC)
ROVER, Y884, Y885	RWY34R	RWY16L	RWY16R <sup>(*1)</sup>
Y18(*2)	RWY34R	RWY16L	RWY16R
	RWY05	RWY16R	RWY22
Y20(*2)	RWY34R	RWY16L	RWY16R
	RWY05	RWY16R	RWY22
Y28, Y56, XAC	RWY05	RWY16R	RWY22

(Note1) \*1 Scheduled flight only for North America, Europe and Turkey will be assigned RWY16L.

(Note2) \*2 Departure runway will be assigned when Flight schedule is fixed.

(Note3) ATC may assign other runway that listed above, if required.

- (11) Runway is predetermined by flight direction.  
Aircraft which uses RWY05 for take off shall comply with the aircraft weight restriction. Even though aircraft weight exceeds the restriction, the other runway shall not be used.(see RJTT AD2.23.7)
- (12) Prior notice of spot number before landing  
All arriving aircraft should notify control tower of the parking spot number at initial contact.

(13) GROUND CONTROL Frequency  
See attached chart

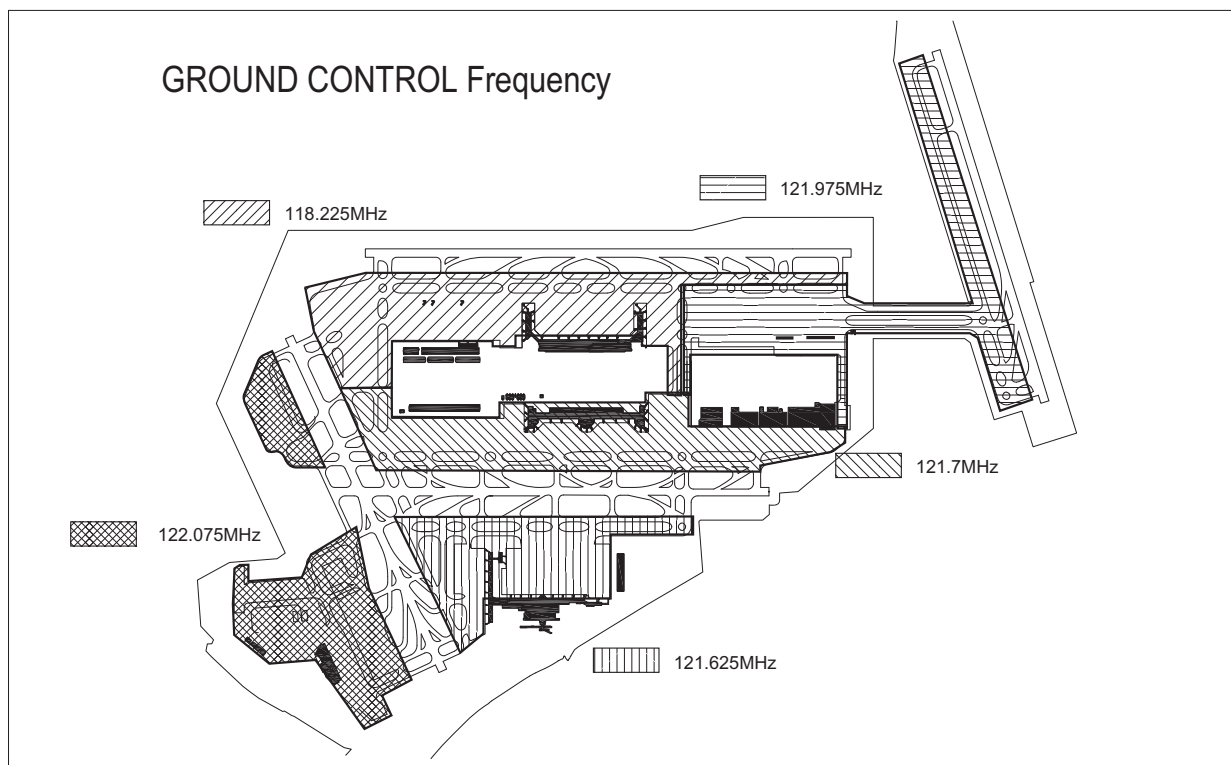

1.3 Intersection departure

- (1) When RWY 34R/16L, 05, 16R, 04/22 is in use, departing aircraft may be instructed intersection departure from C2, C3, C13, D2, A15/L15, A14/L14, B2/T2 or B13 without pilot's consent. Aircraft unable to depart from C2, C3, C13, D2, A15/L15, A14/L14, B2/T2 or B13 intersection shall advise "TOKYO GROUND/TOWER" accordingly.
- (2) Separation for departure as in AD1.1.6.3.2.2(2) will not be applied to aircraft departing from TWY C13, D2, B2/T2, B13, TWY C3 behind departing aircraft from C2 or A14/L14 behind departing aircraft from A15/L15. Aircraft requiring separation in AD1.1.6.3.2.2(2) shall advise "TOKYO GROUND/TOWER" accordingly.
- (3) The remaining runway length for intersection departures are as follows.

RWY	TWY	Remaining RWY length *
34R	C2	2,920m(9,590ft)
	C3	2,820m (9,250ft)
	C5	2,420m (7,930ft)
	C6	2,100m (6,880ft)
	C7	1,780m (5,830ft)
16L	C13	3,180m (10,440ft)
	C12	2,800m (9,190ft)
	C11	2,480m (8,160ft)
	C10	2,030m (6,680ft)
	C9	1,650m (5,430ft)
34L	A2	2,520m (8,260ft)
	A3/L3	2,420m (7,960ft)
	A4/L4	2,320m (7,630ft)
	A5	2,010m (6,590ft)
	L5	1,980m (6,490ft)
	A6/L6	1,890m (6,200ft)
	A7	1,570m (5,150ft)
	A9/L9	1,470m (4,820ft)
	16R	RWY 04/22
A15		2,600m (8,550ft)
L15		2,550m (8,370ft)
A14		2,490m (8,190ft)
L14		2,440m (8,010ft)
A13		2,310m (7,570ft)
A12		2,000m (6,560ft)
L13		2,080m (6,850ft)
L12		1,800m (5,910ft)
A11/L11		1,930m (6,350ft)
A10		1,500m (4,920ft)
04	B2/T2	2,310m (7,570ft)
	B3/T3	2,030m (6,670ft)
	B4/T4	1,800m (5,900ft)
	B5/T5	1,810m (5,950ft)
	B6/T6	1,530m (5,030ft)
22	B13	2,320m (7,620ft)
	B12	1,930m (6,340ft)
	T12	1,880m (6,170ft)
	B11	1,660m (5,460ft)
	T11	1,630m (5,370ft)
	B10	1,580m (5,190ft)
	B9	1,470m (4,830ft)
	T9	1,520m (5,010ft)
05	D2	2,320m (7,620ft)
	D3	1,800m (5,900ft)
	D4	1,880m (6,170ft)
	D5	1,500m (4,920ft)

\*Rounded down to the nearest 10m(10ft) from the measurement between the point where TWY CL meets RWY CL and RWY THR.

1.4 Pilot should hold at RWY-holding position markings beside RWY guard lights are turned on at the TWY C1, C2, C3, C5, C12, C13 and C14.

Remarks; RWY-holding position markings and RWY guard lights are located at 75m and 90m off the runway center line on those TWY.(see RJTT AD2.24-ADC-1)

1.5 機材制限

B747-100/100SR, -200/200SR, -300/300SR 及び -SP (いわゆる、「クラシックジャンボ」) については、緊急機または国の航空機を除き運航は許可されない。

1.5 Aircraft type restrictions

B747-100/100SR, -200/200SR, -300/300SR and -SP(so-called "B747 Classics") are not allowed to operate all day except in emergency or state aircraft.

1.6 補助動力装置 (APU) の使用制限

航空機が対象スポットを使用する場合は、管理者が特に認める場合を除き、次に掲げる時間を超えて補助動力装置を使用してはならない。

- (1) 出発予定時刻前の分 30 間
- (2) 到着後、地上からの動力設備が使用可能となるまでに必要とする最小限度の時間
- (3) 航空機が点検整備のため補助動力装置を必要とする場合は最小限度の時間

注) 対象スポットは、1 ~ 5R、5、6 ~ 24、51 ~ 73、105P、106 ~ 114、142 ~ 149 とする。

1.6 Restrictions about the use of auxiliary power units(APU)  
When an aircraft is using following aircraft parking stand, APU shall not be used outside the time periods specified below except when specifically acknowledged by the authority as necessary.

- (1) Less than 30 minutes prior to the estimated time of departure.
- (2) The minimum time required for switching over to the fixed power facilities, after arrival at the parking stand.
- (3) For the minimum time required for aircraft maintenance purposes if needed.

NOTE) Aircraft parking stand: Spot NR1-5R, 5, 6-24, 51-73, 105P, 106-114, 142-149.

1.7 PDA (parts departing aircraft) reporting to Airport Administration

In order to secure the safety of aircraft operations and to rectify the issue of falling objects from aircraft operating in the vicinity of Tokyo International Airport, aircraft operators are required to notify Airport Administration (Tel 03-5756-1531) of any "Parts Departing Aircraft" from flights operating to/from Tokyo International Airport, without delay. This information shall be shared by relevant parties in order to prevent recurrence of such.

2. Taxiing to and from stands

2.1 スポット 33 ~ 41 からのスポットアウト手順

プッシュバック後に、プッシュバックレーンから誘導路 W へ自走を行う場合は、使用スポット導入線とプッシュバックレーンの交点付近から、隣接スポット導入線と誘導路 W の誘導路中心線との交点付近を会合点として実施すること。ただし、管制官からプッシュバックレーンの走行を指示された場合<sup>\*1\*</sup>は、プッシュバックレーンを走行した後、地上走行補助線を経由して誘導路 W へ自走すること。

プッシュバック後にプッシュバックレーンから誘導路 J 又は誘導路 J1 へ自走を行う場合は、プッシュバックレーンを走行した後、地上走行補助線を経由して誘導路 J 又は誘導路 J1 へ自走すること。

\*1 例: "TAXI VIA PUSHBACK-LANE TO W TWY"

\*2 例: "TAXI VIA PUSHBACK-LANE TO J TWY"

2.1 Spot OUT procedure from spot 33-41

After pushing back, ACFT taxiing from the Pushback-lane to TWY W, shall proceed to TWY W from the intersection of the Pushback-lane and the guide lane for the used spot, so as to intercept TWY W center line near the point crossing the guide lane for the next spot. However, when instructed to taxi via the Pushback-lane by ATC<sup>\*1\*</sup>, ACFT shall taxi on the Pushback-lane and then proceed via the auxiliary taxiing line to TWY W.

After pushing back, ACFT taxiing from the Pushback-lane to TWY J or TWY J1, shall taxi on the Pushback-lane and then proceed via the auxiliary taxiing line to TWY J or TWY J1.

\*1 example: "TAXI VIA PUSHBACK-LANE TO W TWY"

\*2 example: "TAXI VIA PUSHBACK-LANE TO J TWY"

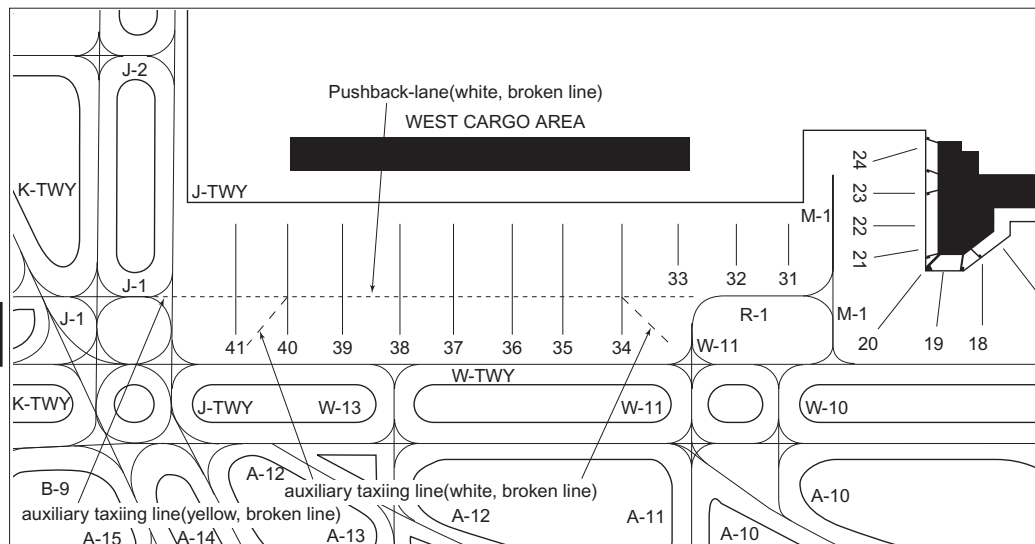

2.2 Standard taxiing route(See attached chart RJTT AD2.20)

The standard taxiing routes for departure and arrival may be instructed by ATC, using route ID in the table below.

	Direction	Route ID	Routing Via
Departure	To RWY05	ROUTE 5	TWY A-R-S
Arrival	From RWY23		TWY S-R-A

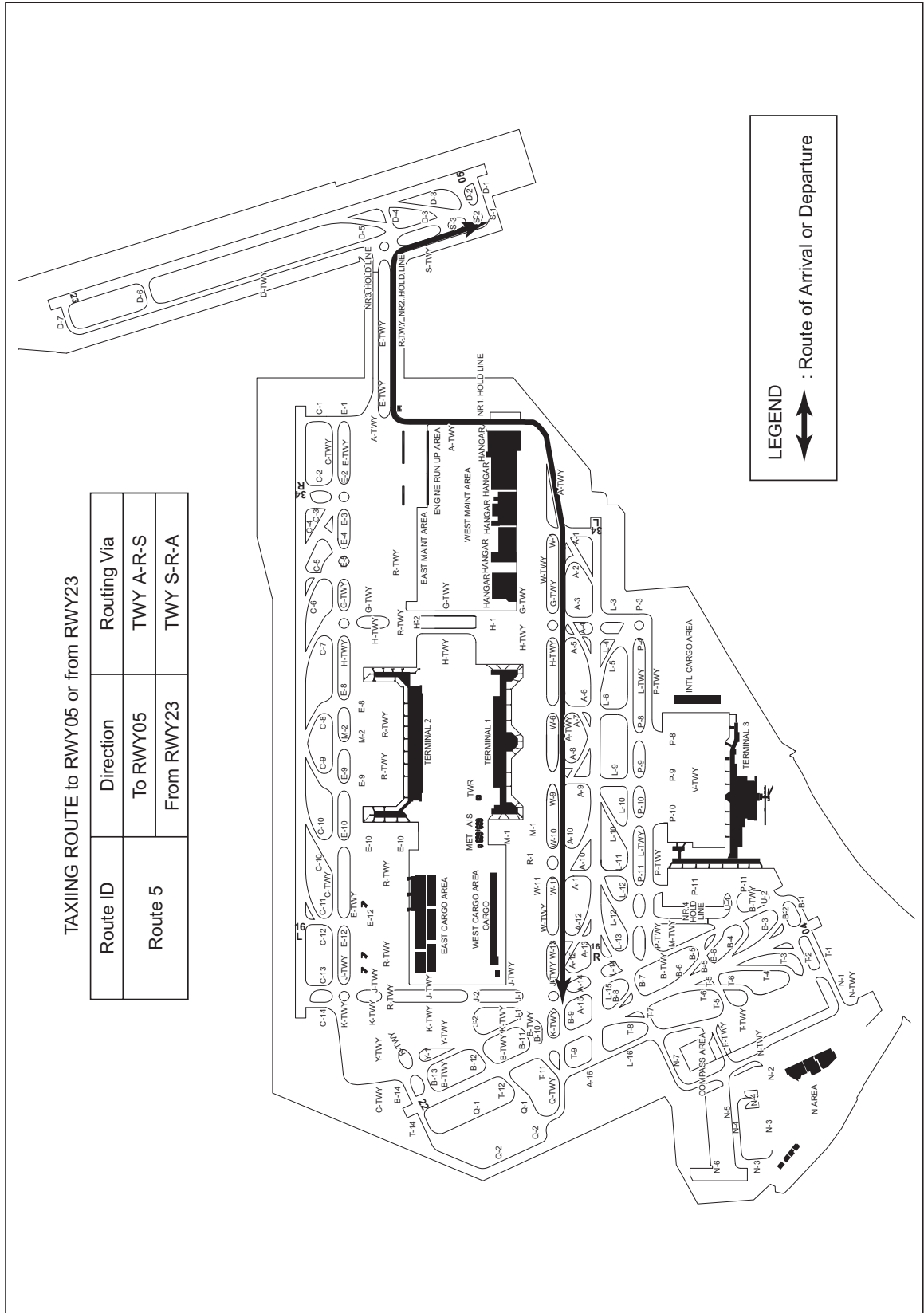

3. Parking area for small aircraft(General aviation)

The following markings shown on the Fig.1 below are installed on the parking area for small aircraft.

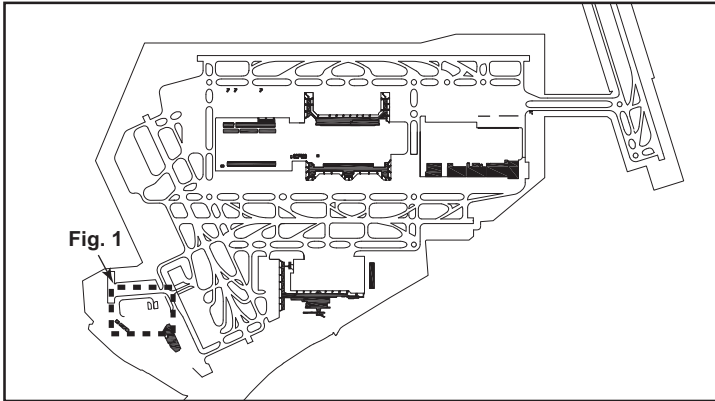
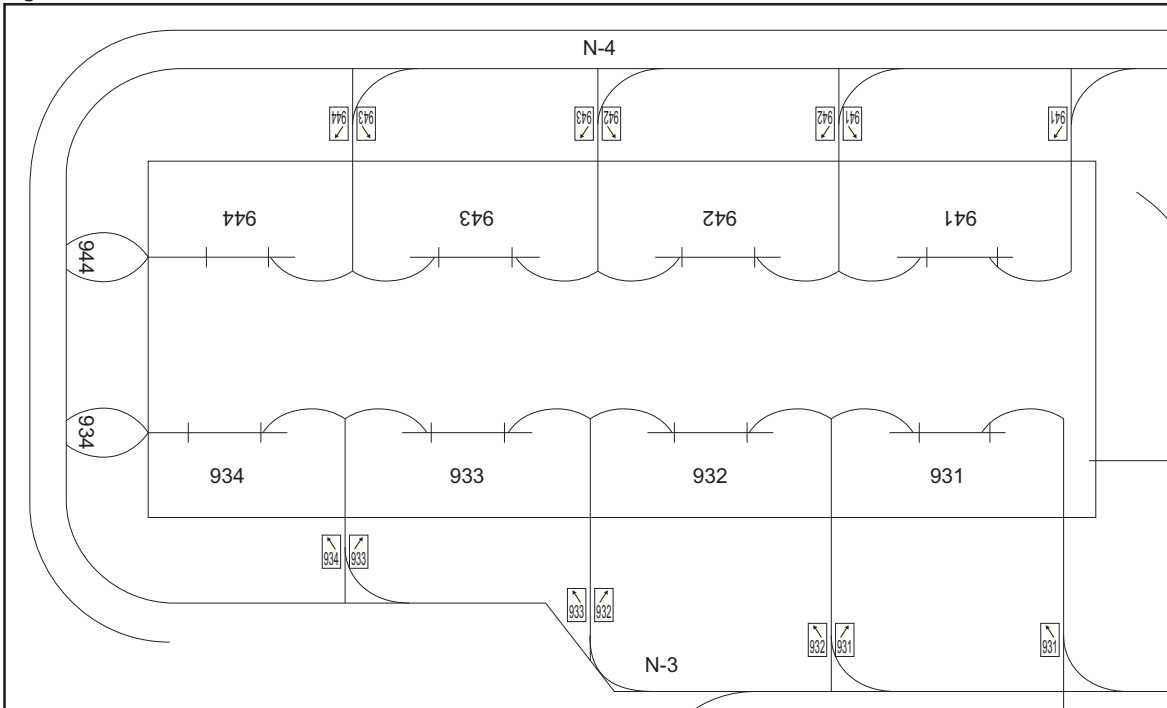

Fig. 1





4. Parking area for helicopters

Nil
-----

5. Apron - taxiing during winter conditions

Nil
-----

6. Taxiing - limitations

6.1 Restricted taxiways

(a)The aircraft of which wing span (WS) listed below table shall not pass following TWY or ACFT stand taxilane.

Restricted TWY or ACFT stand taxilane	WS	REMARKS
A(BTN A1 and A3), A(BTN A1 and W)	WS >= 74m	
A2, A5(BTN RWY16R/34L and A4), A5(BTN A3 and A4), A7, A8, A10, A13(BTN A and A12), A13(BTN RWY16R/34L and A12), B8, B9, B10, B11, J1(BTN B and K), J1(BTN K and J), C(BTN K and R), C4, C8, C9, C10, C13, E(BTN J and K), E3(BTN E and R), E4, E8(BTN C and E), E9(BTN C and E), E10(BTN C and E), E12, H1, L10, M2(BTN C and E), Y(BTN C and R), R(BTN A and G), R(BTN E10 and J), R(BTN G and H), T8, T9, T11, A16, W10, W11(BTN A and W), W(BTN K and B), E(BTN H and J), W13, W(BTN K and J), W(BTN J and M1)	WS >= 69m	
E10(BTN E and spot NR51), R1, J2(BTN K and Y), F, N(BTN spot NR981 and N7), N1, N2, N5, P11(BTN P and U2), U2, U4, W6, W9, W(BTN H and M1), W11(BTN W and R1), M1(BTN R1 and W)	WS >= 65m	
E8(BTN E and R)*, E9(BTN E and R)*, R(from E8 to E9)*, M1(from spot NR22 to spot NR24), M2(BTN E and R)	WS >= 61m	*The restrictions are excepted for B77W. REF AD2.20. 6.1(e)
Q	WS >= 52m	*REF AD2.23. 7
N6	WS >= 36m	Except towed aircraft of which WS below 48m
N3, N4	WS >= 33m	

(b)In order to keep clearance between other aircraft or obstacle, the aircraft of which wing span (WS) listed below table shall reduce taxi speed and shall strictly follow the taxiway center line as following TWY.

Restricted TWY	WS
A(from RU6 to RU7)	78m =< WS < 80m
A(from W to Hangar)	76m =< WS < 80m
E(from spot NR801 to NR807), E(from spot NR808 to NR811)	72m =< WS < 80m
W(from spot NR201 to NR214), P8(BTN P and V), P9(BTN P and V), P10(BTN P and V) and V	71m =< WS < 80m
C(BTN K and R), E3(BTN E and R), E12(BTN E and R), E(BTN H and J), Y(BTN C and R), R(BTN A and G), R(BTN E10 and J), W(BTN J and M1)	63m =< WS < 69m
W(from spot NR5 to NR20), R1, E10(from spot NR55 to spot NR51), J2(BTN K and Y), P11(BTN P and U2) and F	55m =< WS < 65m
M2(BTN E and R)	55m =< WS < 61m

(c)All aircraft shall taxi with minimum power when taxiing on apron taxiways in order to avoid blast damage to vehicles running along apron taxiways.

(d)In order to keep clearance between aircrafts and the fence etc, (31.5m from taxiway center line, 1.1m/AGL) which is installed on the bridge of E, P and R taxiway, all aircrafts shall reduce taxiing speed and follow the taxiway center line strictly.(see below chart)

E, P 及び R 誘導路橋梁部に設置されるフェンス等 (誘導路中心線から 31.5m, 地上高 1.1m) と機体との間のクリアランスを確保するために、すべての航空機は速度を減じて且つ誘導路中心線を走行することを厳守すること。(下图参照)

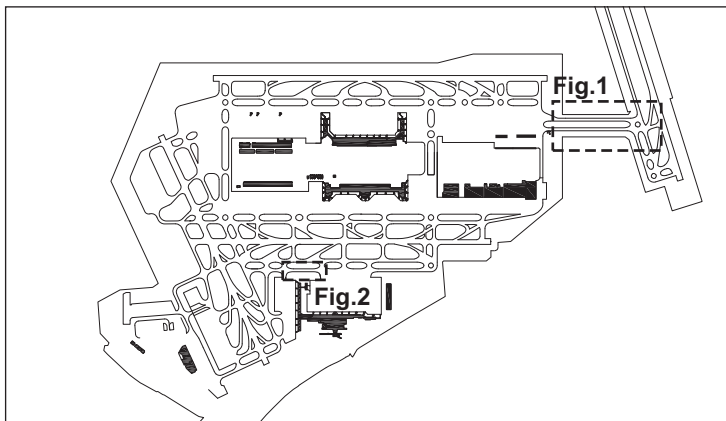

Fig.1

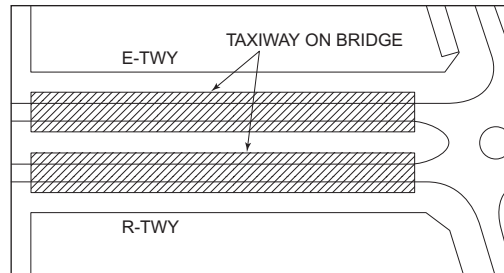
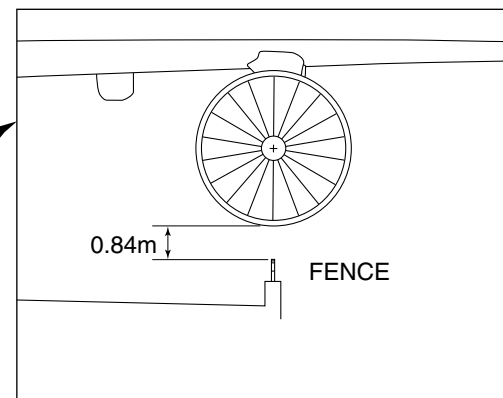
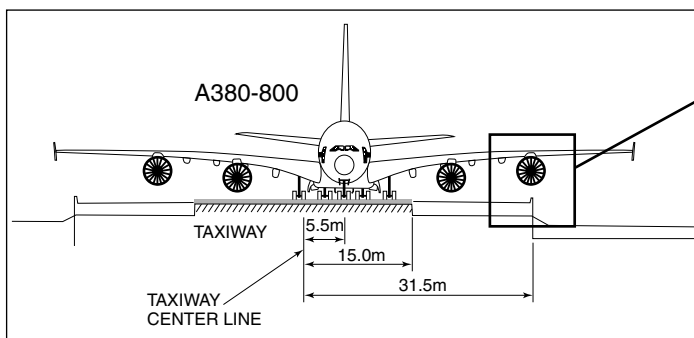
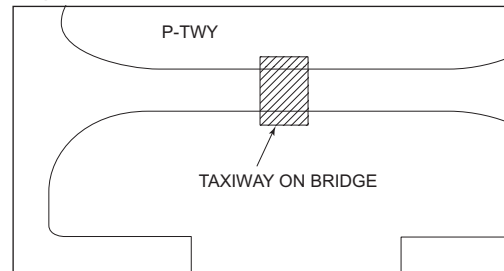

Fig.2



(e) Taxiway required to pay special attention are shown on attached chart.  
(See RJTT AD2.20.6.1(a) and (b))

1) A340-500 における注意して走行すべき誘導路

1) TWY required to pay special attention for A340-500

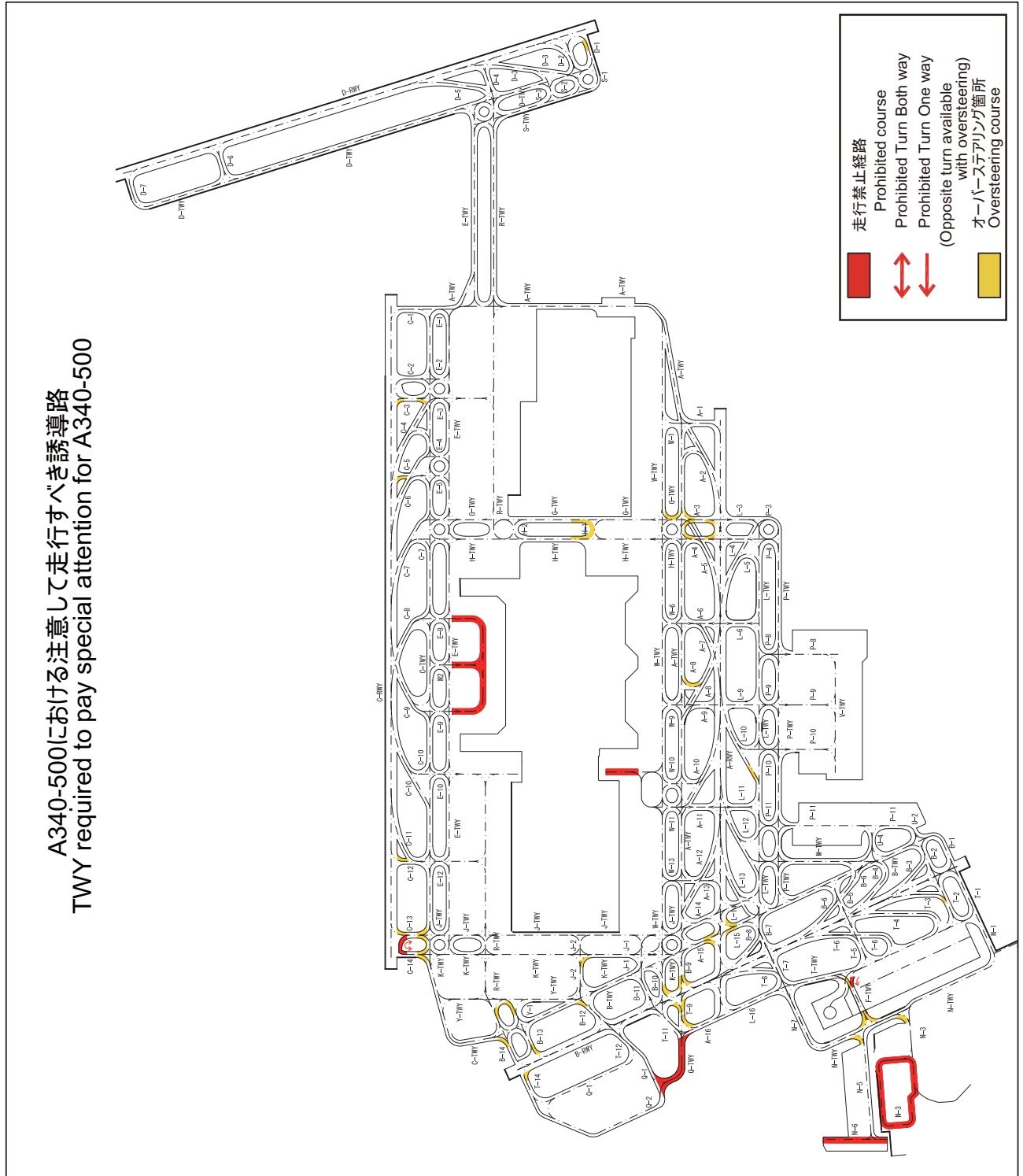

2) A340-600における注意して走行すべき誘導路

2) TWY required to pay special attention for A340-600

A340-600における注意して走行すべき誘導路  
TWY required to pay special attention for A340-600

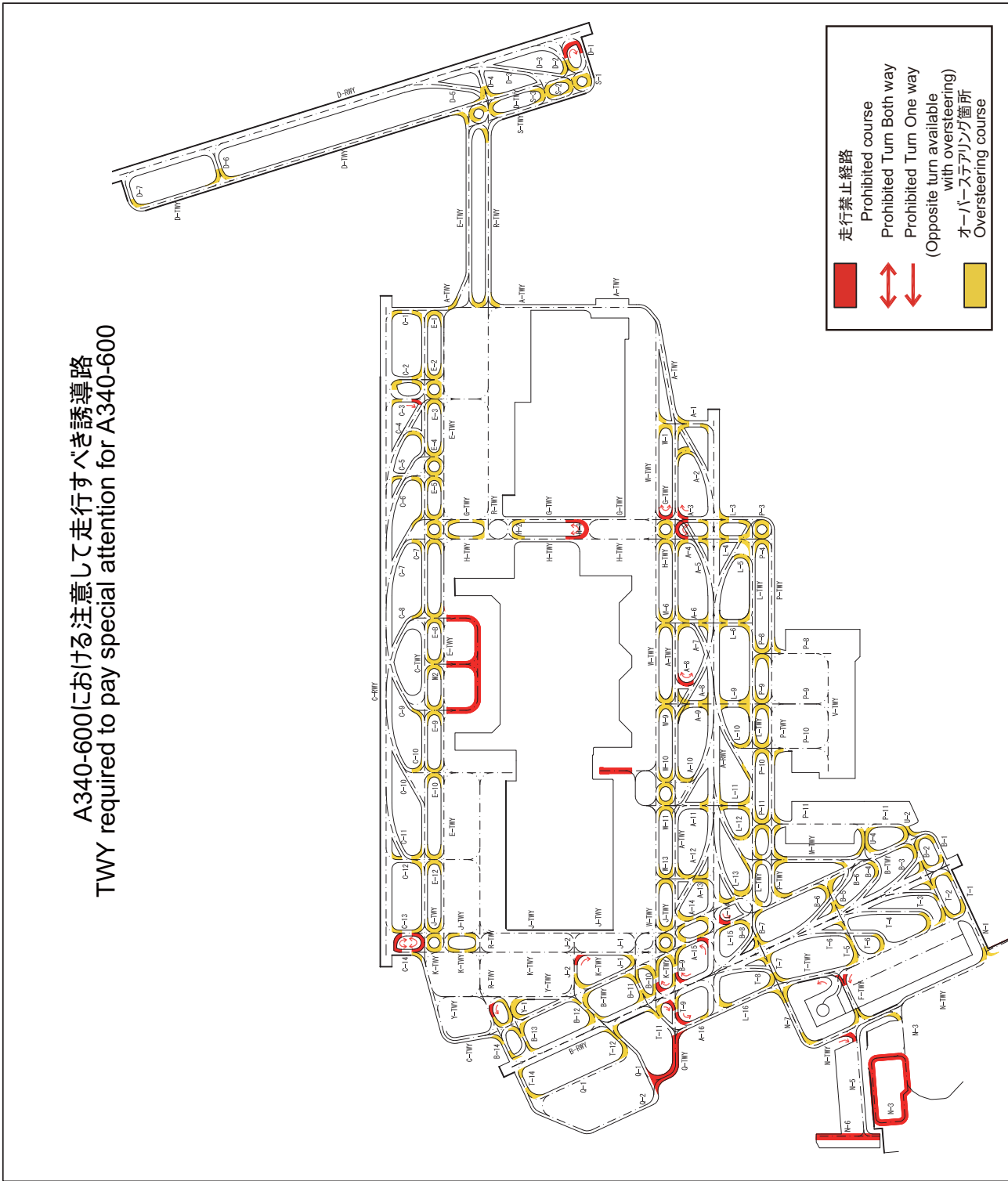

3) A350-900 における注意して走行すべき誘導路

3) TWY required to pay special attention for A350-900

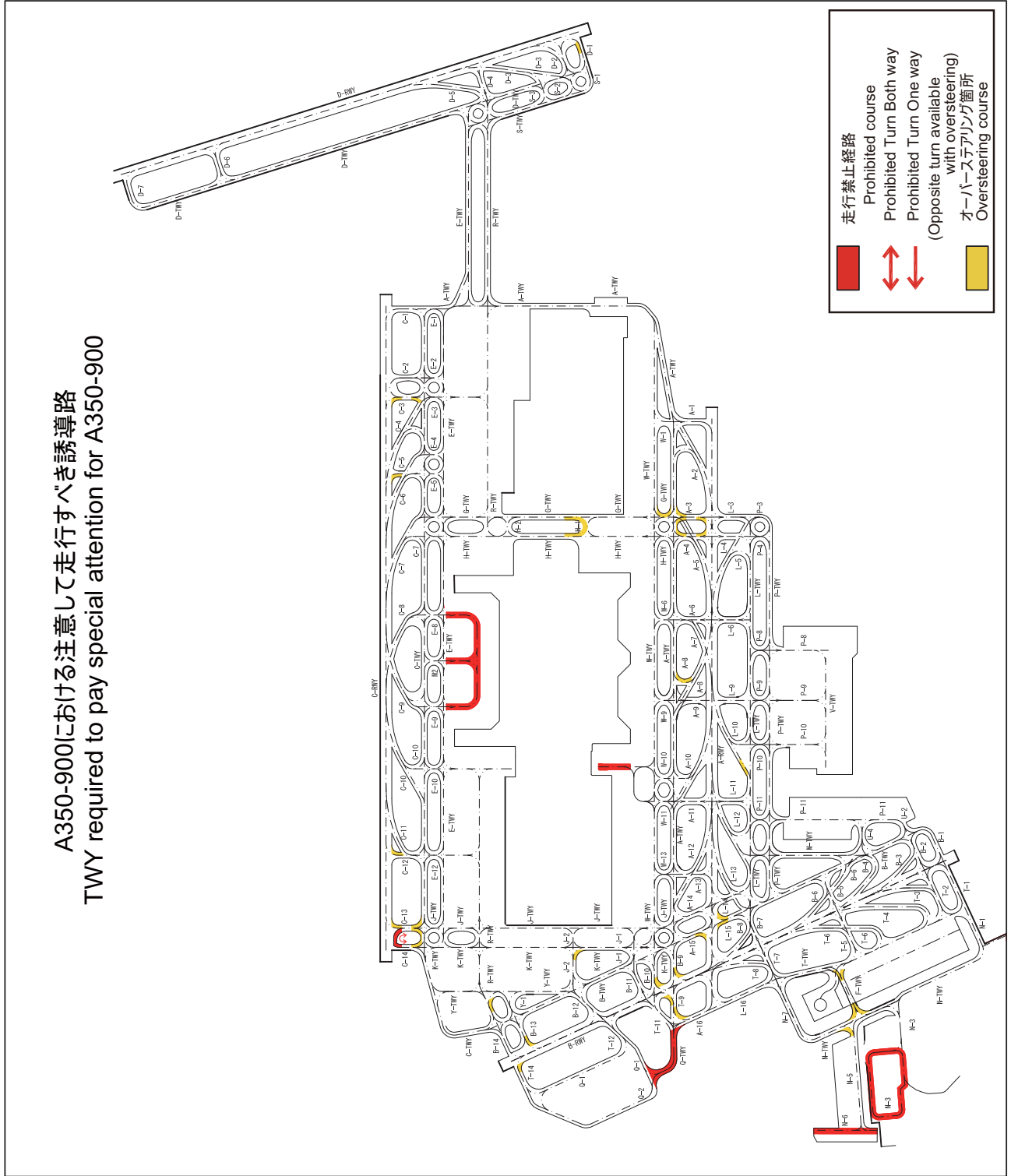

4) A350-1000 における注意して走行すべき誘導路

4) TWY required to pay special attention for A350-1000

A350-1000における注意して走行すべき誘導路  
TWY required to pay special attention for A350-1000

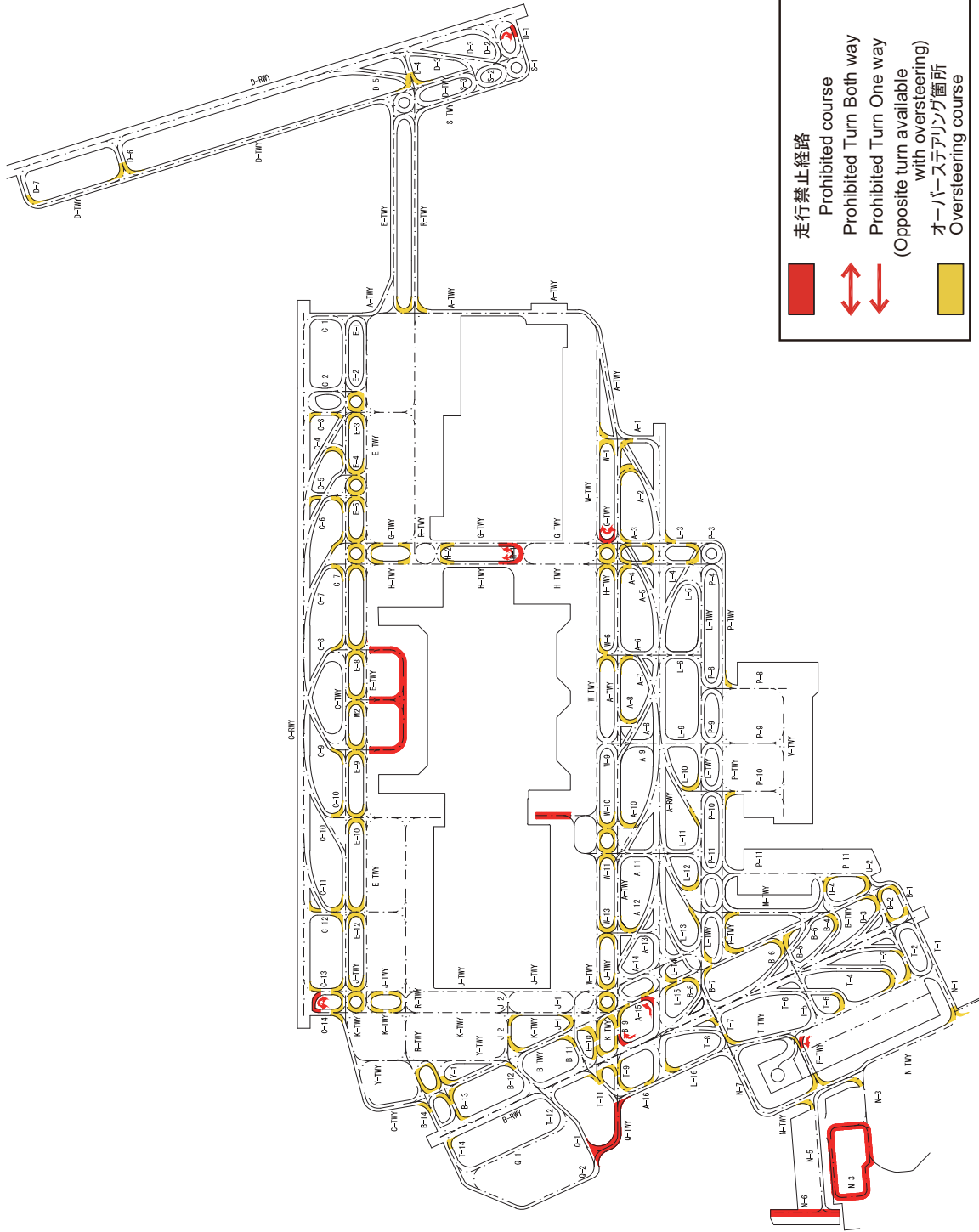

5) A380-800 における注意して走行すべき誘導路

5) TWY required to pay special attention for A380-800

A380-800における注意して走行すべき誘導路  
TWY required to pay special attention for A380-800

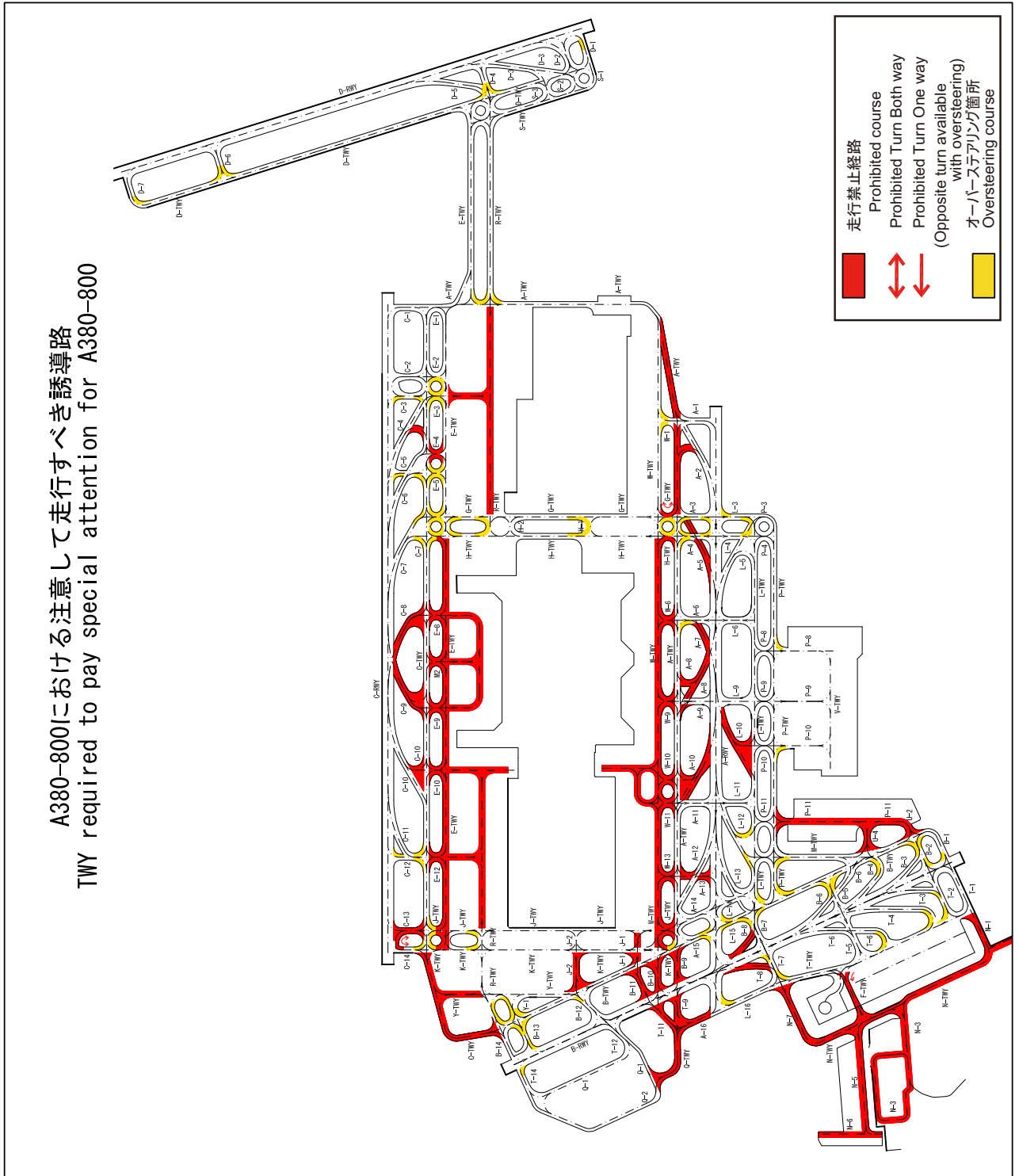

6) B747-8 における注意して走行すべき誘導路

6) TWY required to pay special attention for B747-8

B747-8における注意して走行すべき誘導路  
TWY required to pay special attention for B747-8

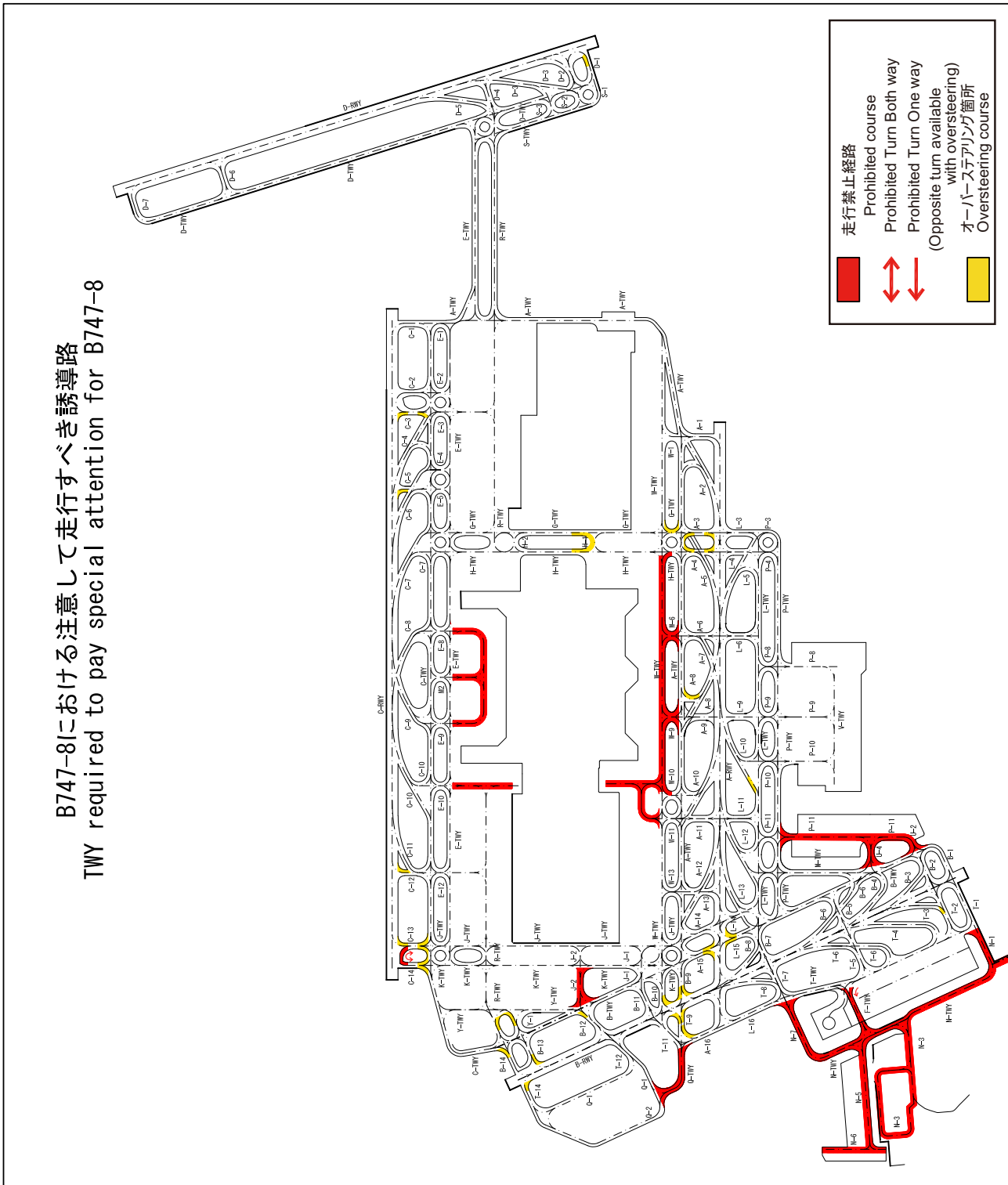



7) B767-400ERにおける注意して走行すべき誘導路

7) TWY required to pay special attention for B767-400ER

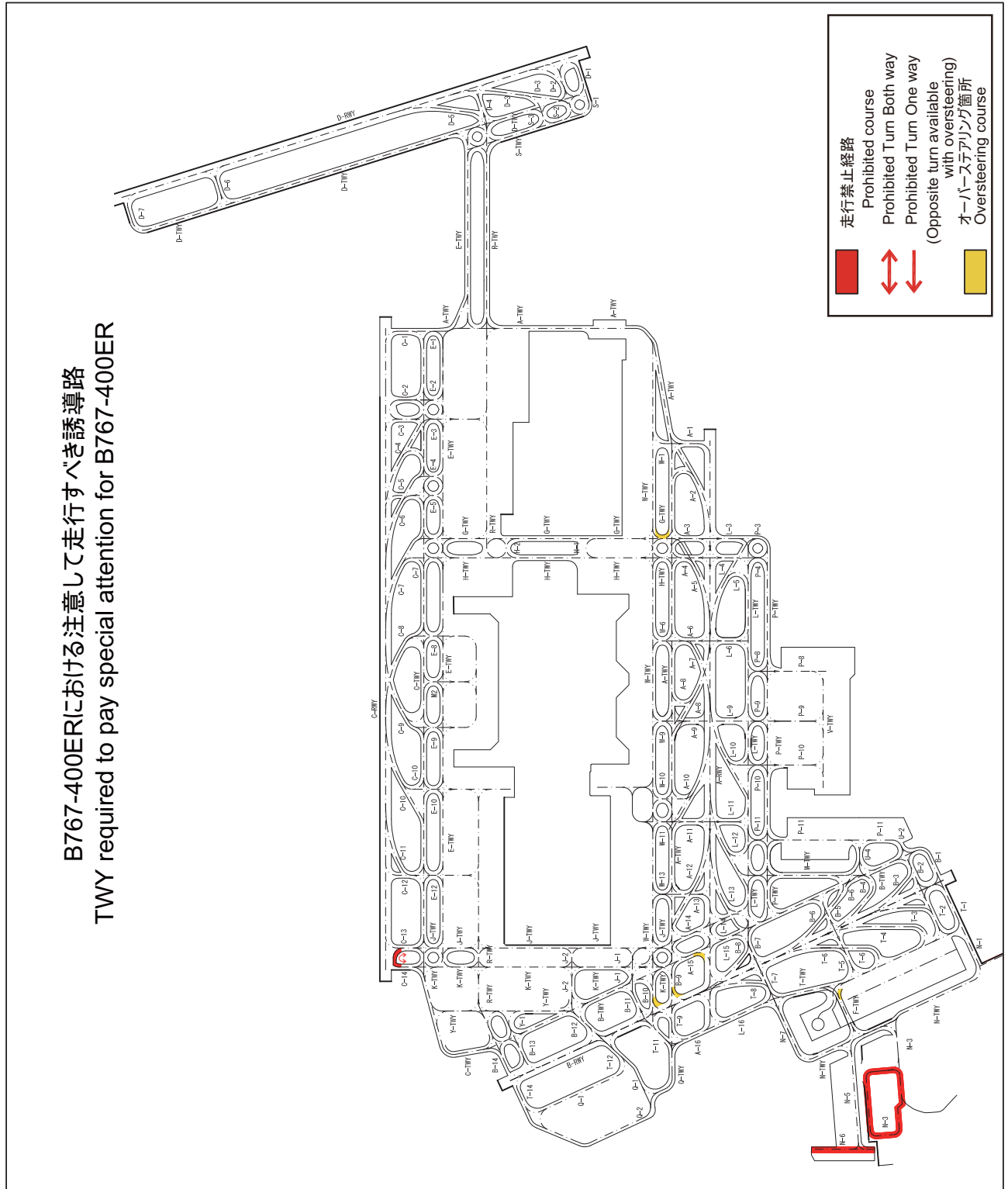

8) B777-300における注意して走行すべき誘導路

8) TWY required to pay special attention for B777-300

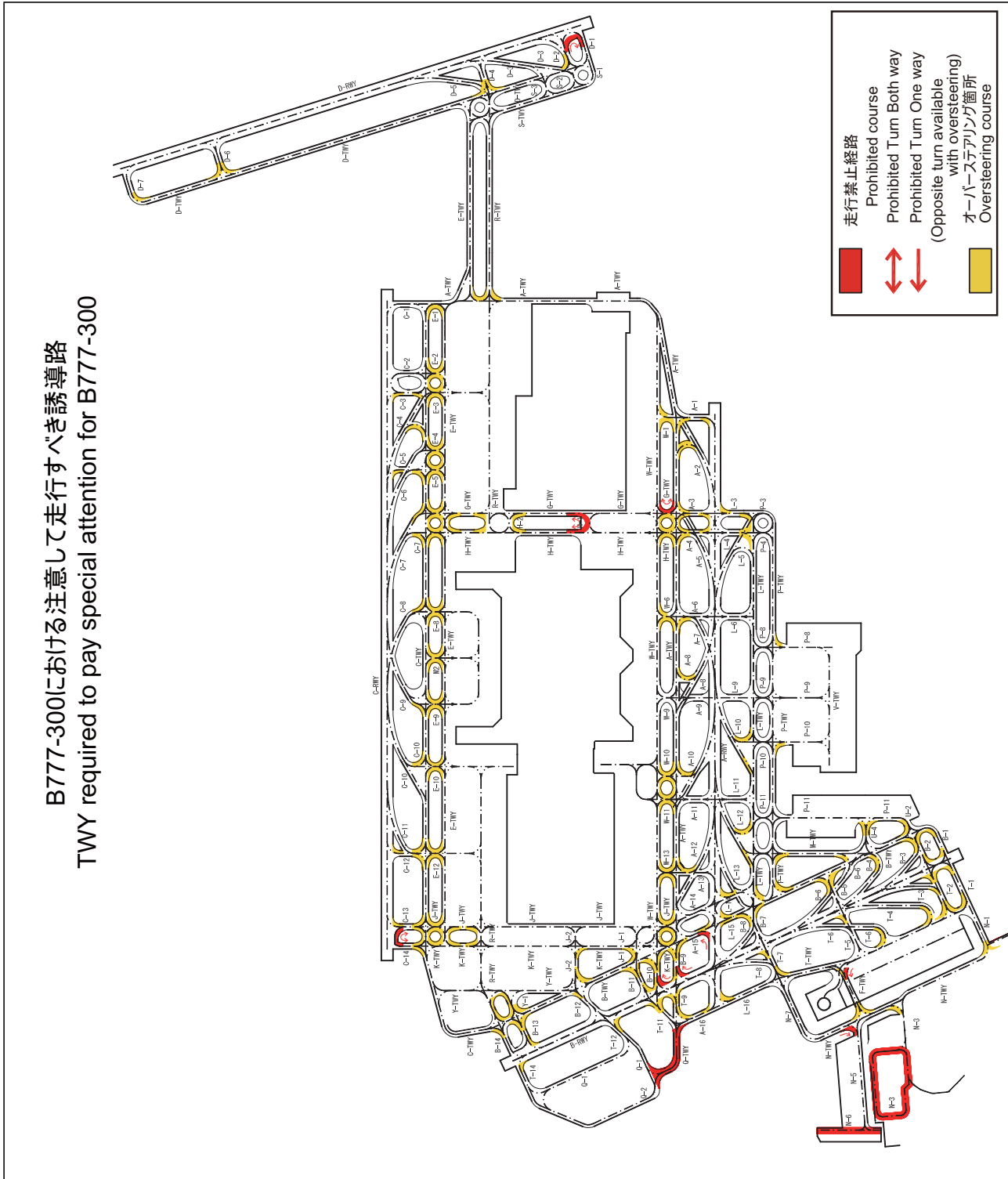

9) B777-300ERにおける注意して走行すべき誘導路

9) TWY required to pay special attention for B777-300ER

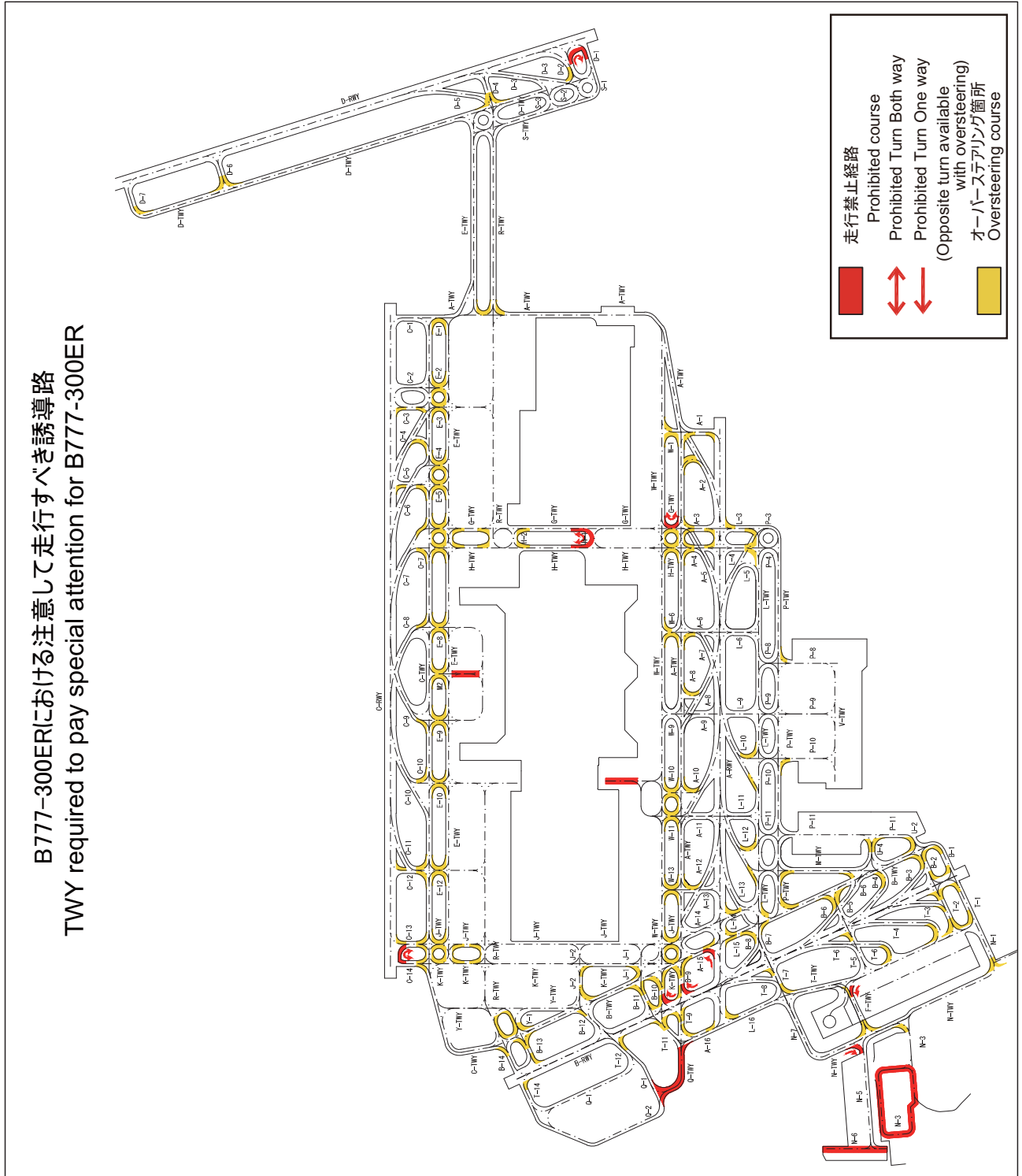

10) B787-8 における注意して走行すべき誘導路

10) TWY required to pay special attention for B787-8

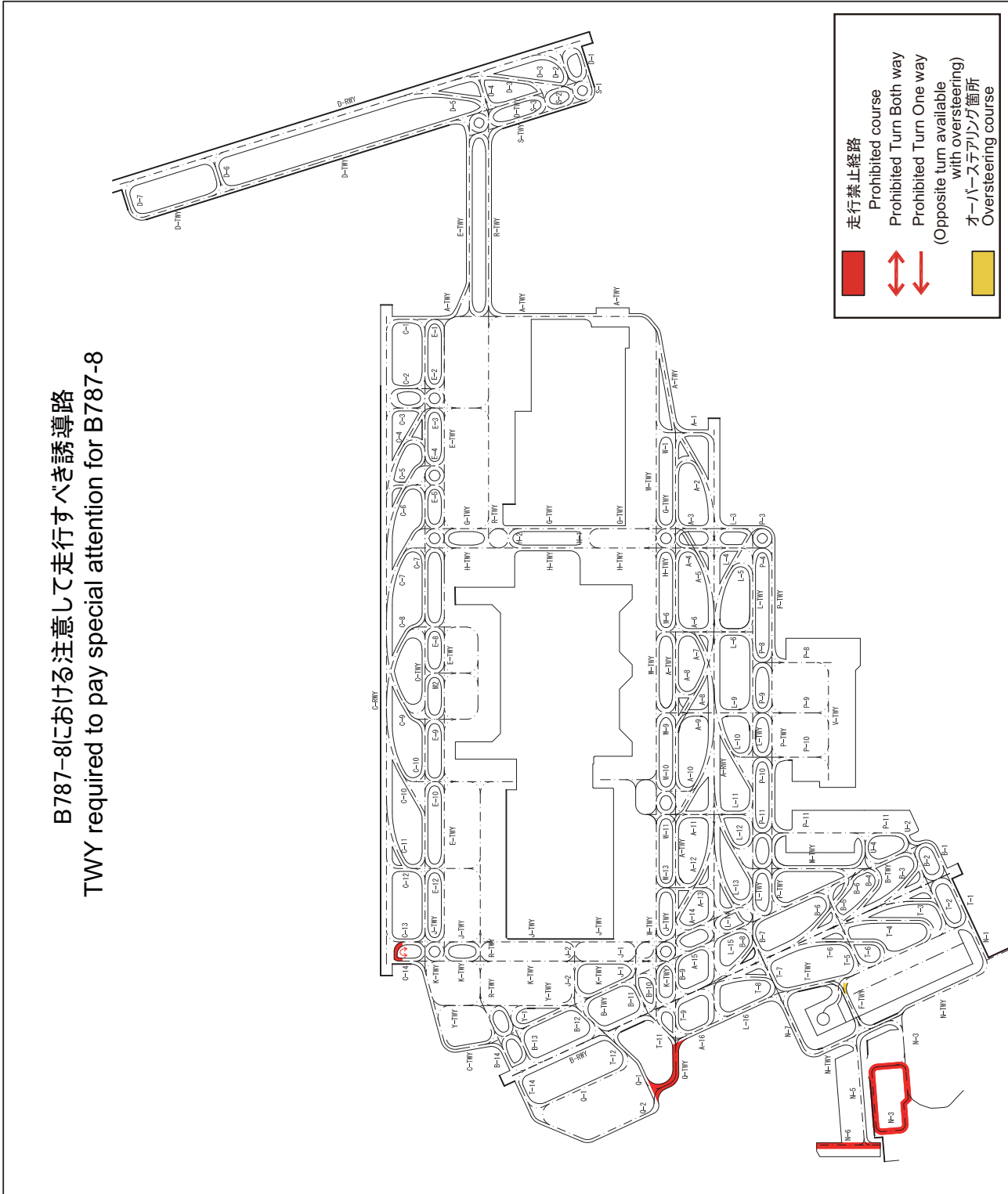

11) B787-9における注意して走行すべき誘導路

11) TWY required to pay special attention for B787-9

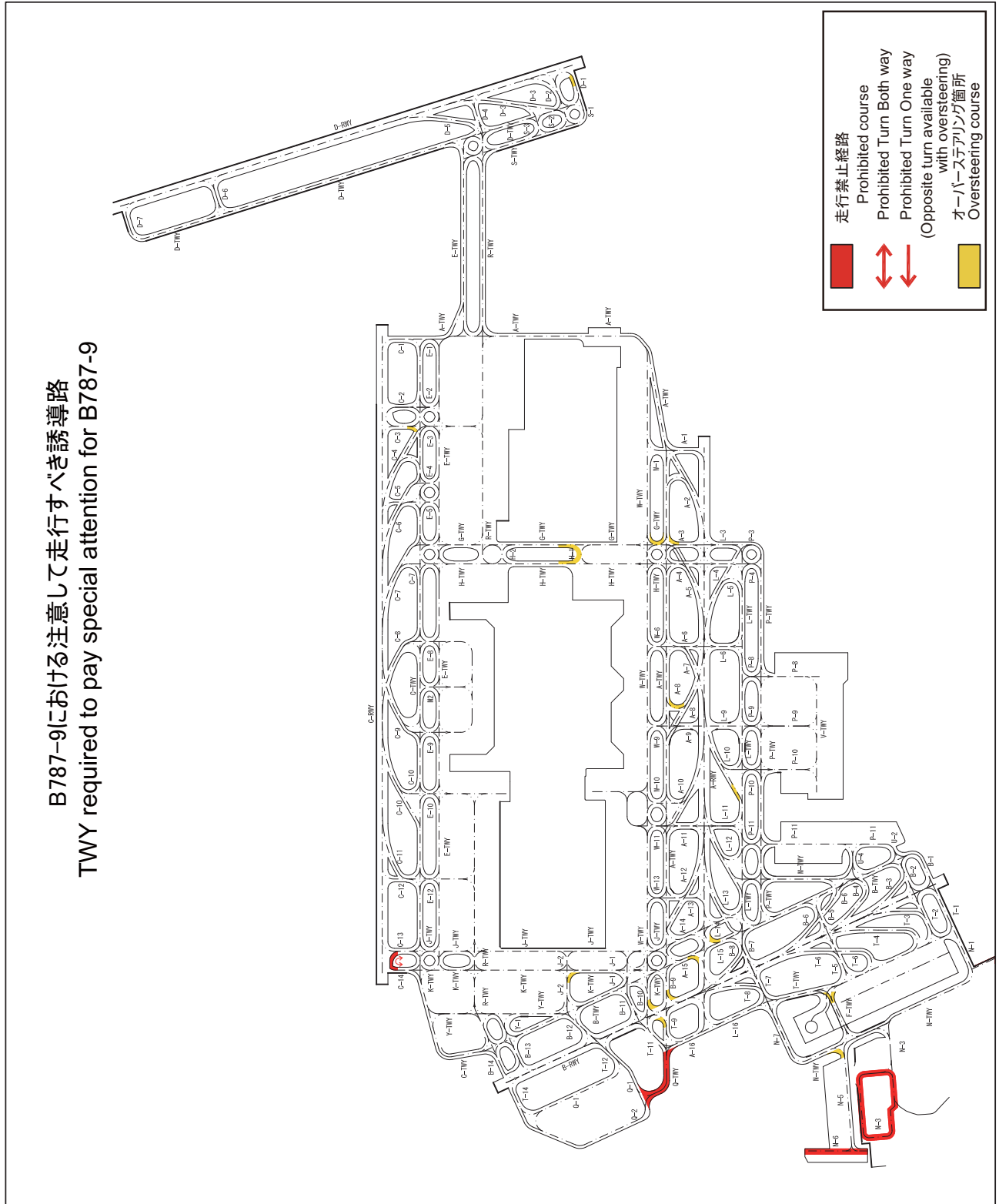

12) B787-10 における注意して走行すべき誘導路

12) TWY required to pay special attention for B787-10

B787-10 における注意して走行すべき誘導路  
TWY required to pay special attention for B787-10

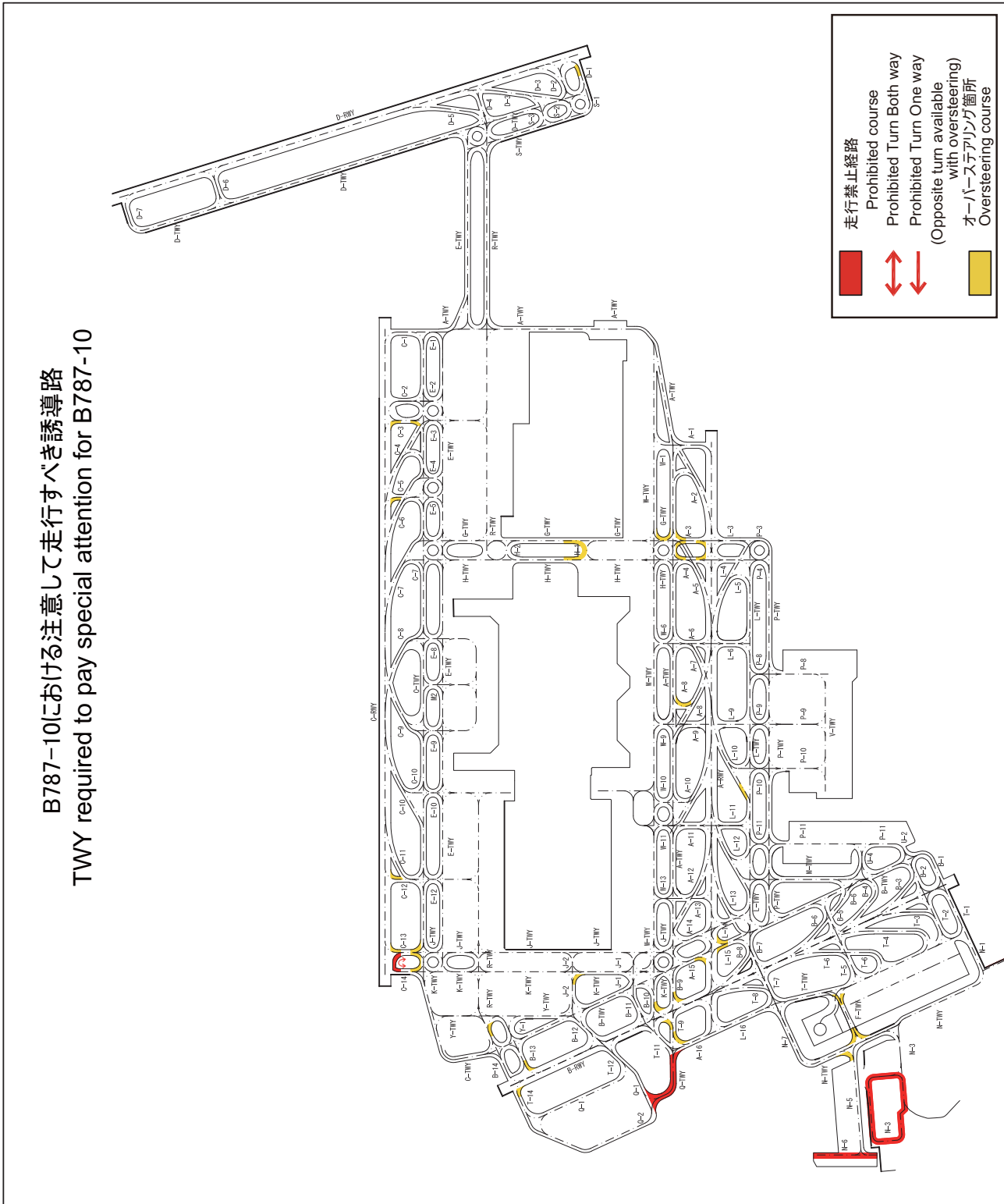

6.2 All aircraft shall hold at "GP HOLD LINE" on TWY A1, A12, A13, C12, B13, B14 until receiving further taxi clearance in order to protect ILS glide slope signal. (See RJTT AD2.24-APDC-1)

6.3 Wing tip clearance at the TWY intersection (REF. AD1.1.6.8)

Wing tip clearance at the TWY intersection between the ACFT holding at the stop marking on the TWY and the other ACFT taxiing behind it are as follows.

1) When B748 holding at the stop marking on TWY C1, C2, C3, C5, C12, C13, or C14

wing span (WS) of ACFT taxiing on TWY C <sup>*1</sup>	WS ≤ 28.8m	28.8m < WS ≤ 45.8m	WS > 45.8m
wing tip clearance	A	B	×
wing span (WS) of ACFT taxiing on TWY C <sup>*2</sup>	WS ≤ 15.8m		WS > 15.8m
wing tip clearance	B		×
*1 When B748 holding at the stop markings located at 75m off the RWY center line. *2 When B748 holding at the stop markings located at 90m off the RWY center line.			

2) When B748 holding at the stop marking on TWY T9

wing span (WS) of ACFT taxiing on TWY A16	WS ≤ 5.8m	WS > 5.8m
wing tip clearance	*B	*×

3) When B748 holding at the stop marking on TWY T7

wing span (WS) of ACFT taxiing on TWY T	WS ≤ 25.8m	WS > 25.8m
wing tip clearance	B	×

4) When B748 holding at the stop marking on TWY A14, A15, B9, B10, L14 or L15

wing span (WS) of ACFT taxiing on TWY B, L or TWY A	WS ≤ 21.3m	21.3m < WS ≤ 38.3m	WS > 38.3m
wing tip clearance	A	B	×

5) When B748 holding at the stop marking on TWY A3, A4, A6, A9, A11, A13, B2, B5, B7, B11, B13, B14, D1, D2, D4, D6, L3, L4, L6, L9 or L11

wing span (WS) of ACFT taxiing on TWY A, B, D or TWY L	WS ≤ 28.8m	28.8m < WS ≤ 45.8m	WS > 45.8m
wing tip clearance	A	B	×

6) When B748 holding at the stop marking on TWY B12

wing span (WS) of ACFT taxiing on TWY B	WS ≤ 17.9m	17.9m < WS ≤ 34.9m	WS > 34.9m
wing tip clearance	A	B	×

7) When B748 holding at the GP HOLD LINE on TWY A1

wing span (WS) of ACFT taxiing on TWY W	WS ≤ 24.6m	WS > 24.6m
wing tip clearance	B	×

Legend
A: wing tip clearance ≥ 15m
B: 6.5m ≤ wing tip clearance < 15m
×: wing tip clearance < 6.5m
*B: 10.5m ≤ wing tip clearance < 15m
*×: wing tip clearance < 10.5m



- 6.4 A 誘導路又は M 誘導路を西に向けて走行する航空機及び、R(A と S の間) 誘導路又は E 誘導路を南に向けて走行する航空機は、管制機関に指示された場合に限り、中間待機位置標識または中間待機位置灯で停止し待機する。(RJTT AD2.9.2 及び AD2.24 を参照)
- 6.5 (a) Spot NR104, NR105P, NR105F 及び NR106 へのスポットインの方法 (添付図参照)
- (1) Spot NR104 及び spot NR106  
各スポットの航空機導入線に沿ってスポットインすること。
  - (2) Spot NR105P  
Spot NR105P の航空機導入線に沿ってスポットインする。ただし、NR103 に航空機が駐機している場合は、航空機ブラストの影響を避けるため、コード D 以上の航空機 (翼幅が 36m 以上) は航空機導入線上の停止位置で停止し、エンジンカットした後、トーイングによりスポットインする。
  - (3) Spot NR105F  
Spot NR106 の航空機導入線に沿って走行し、spot NR106 の航空機導入線上の停止位置で停止し、エンジンカットした後、spot NR105F にトーイングによりスポットインする。

- 6.4 The aircraft taxiing to the west on TWY A or TWY M and taxiing to the south on TWY R(between A and S) or TWY E shall hold at Intermediate Holding Position Marking or Intermediate Holding Position Lights only when instructed by ATC.  
(see RJTT AD2.9.2 and AD2.24)
- 6.5 (a) Procedures of taxiing to spot NR104, NR105P, NR105F and NR106(see attached chart)
- (1) Spot NR104 and NR106  
The aircraft should strictly follow the taxiing guide line.
  - (2) Spot NR105P  
The aircraft should strictly follow the taxiing guide line of the spot NR105P.  
When there is an aircraft at the spot NR103 in order to avoid the blast damage, the aircraft with wingspan 36m or longer should shut down their engines at the stop line installed on the taxiing guide line and then should be pulled into the spot NR105P by the aircraft tug.
  - (3) Spot NR105F  
The aircraft should strictly follow the taxiing guide line of spot NR106, and should shut down engines at the stop line installed on the taxiing guide line, and then should be pulled into the spot NR105F by the aircraft tug.

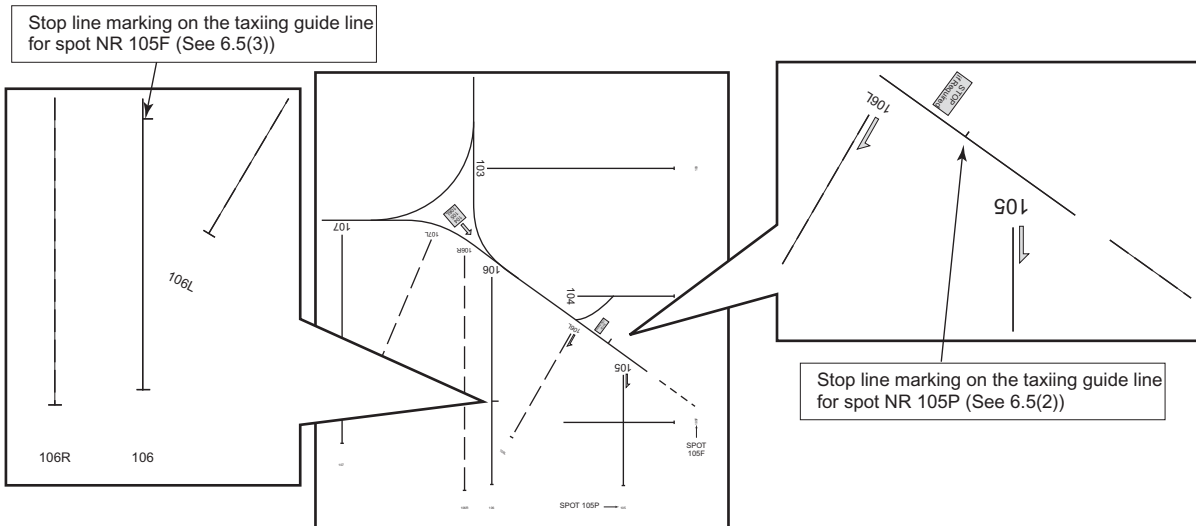

- (b) Spot NR5R のスポットインの方法 (添付図参照)
- W 誘導路を経由してスポット NR5R に入る航空機は、十分に減速して航空機導入線に沿ってスポットインすること。

- (b) Procedure of taxiing to spot NR5R(see attached chart)
- The aircraft should reduce taxi speed and should strictly follow the taxiing guide line of the spot NR5R via W-TWY.

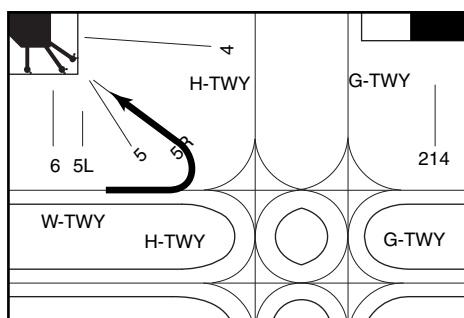



7. School and training flights - technical test flights - use of runways

Nil

8. Helicopter traffic - limitation

Nil

9. Removal of disabled aircraft from runways

Nil

**RJTT AD 2.21 NOISE ABATEMENT PROCEDURES**

1. 騒音制限

東京国際空港においては、以下の騒音軽減運航方式が適用される。

- ・ 優先滑走路方式
- ・ 優先飛行経路及び騒音軽減運航方式
- ・ 騒音軽減進入方式 (NAAP)

1. Noise restrictions

Following noise abatement procedures on Tokyo INTL Airport are in force.

- Noise Preferential Runways
- Preferential Routes and Aircraft Operating Procedures for Noise Abatement
- Noise Abatement Approach Procedure(NAAP)

2. 優先滑走路方式

使用される滑走路は以下の通り。(滑走路閉鎖時又は緊急事態発生時を除く。)

2. Noise Preferential Runways

Runways described below are used except when those runways are not available or urgent situation exists.

(離陸)

(For Take off)

From 2100UTC to 1400UTC	<p>1. 滑走路 05 及び 34R (北風運用時) 又は滑走路 16L 及び 16R (南風運用時) を優先的に使用する。ただし、0600UTC から 1000UTC の南風運用時は除く。(*1)</p> <p>2. 滑走路 04 は、概ね 20 ノット以上の北東強風時又は滑走路 05 もしくは 34R の閉鎖時に使用する。</p>	<p>1. RWY05 and 34R(north wind operation applied) or, RWY16L and 16R(south wind operation applied) are preferentially used. Except during south wind operation from 0600UTC to 1000UTC.(*1)</p> <p>2. RWY04 is used when northeast wind is about 20 knots or more, or, when RWY05 or RWY34R is closed.</p>
----------------------------------	---	--

<p>From 1400UTC to 2100UTC</p>	<ol style="list-style-type: none"> <li>1. 滑走路 05 (北風運用時) 又は 16L (南風運用時) を優先的に使用する。</li> <li>2. 滑走路 05 及び 16L が使用できない場合は滑走路 16R を使用する。</li> <li>3. 滑走路 34R は、北風運用時、以下の a. 又は b. のいずれかの場合であって、加えて 16L 及び 16R のいずれかの滑走路からも安全な離陸が不可能となった場合に限り使用できるものとする。なお、滑走路 34R は、滑走路 05 の使用を前提に計画したものが、本条項に該当した場合に、使用するものであるから、滑走路 05/23 の航空機荷重制限 (RJTT AD2.23.7) を満たすとともに、滑走路 34R の南端から滑走路長 2500m での離陸を行うこと。ただし、機材性能及び路線距離等を考慮して、滑走路 34R の使用があらかじめ認められた便 (以下「指定便」という。) はこの限りではない。この場合、滑走路 34R の南端から滑走路長 3000m での離陸を行うこと。             <ol style="list-style-type: none"> <li>a. 滑走路 05 が閉鎖中である場合</li> <li>b. 出発時において滑走路 05 では背風又は横風制限を超過する場合であって、安全な離陸が不可能な場合</li> </ol> <ul style="list-style-type: none"> <li>* 滑走路 05 からの離陸機又は滑走路 34R への着陸機と、上記 3.b. による滑走路 34R からの離陸機が競合する場合、前者が優先される。</li> <li>* 滑走路 05/23 の航空機荷重制限 (AIP RJTT AD2.23.7) の超過は、上記 3.b. による滑走路 34R の使用理由とはならない。</li> <li>* 上記 3.b. による滑走路 34R からの離陸について、やむを得ないと考えられる範囲を超えた運用がなされた場合、当該号については適用休止又は削除等の措置を執る場合がある。</li> <li>* 指定便以外により滑走路 34R からの離陸を行った運航者は、以下の事項を東京空港事務所環境・地域振興課あてに FAX 又は E メールにより報告するものとする。                 <ol style="list-style-type: none"> <li>a) 当該離陸の日時</li> <li>b) 航空機呼出符号及び航空機型式</li> <li>c) 当該離陸時のウエイト・アンド・バランスのデータ</li> <li>d) 当該離陸を行った理由 (滑走路 05 の閉鎖/背風/横風)</li> <li>e) 風向、風速</li> <li>f) 滑走路の状態 (wet/dry 等)</li> <li>g) その他の関連情報</li> </ol>                 当該離陸が上記 3.b. によるものである場合は、併せて以下の情報を報告すること。                 <ol style="list-style-type: none"> <li>h) 出発時における風速の背風又は横風成分のうち、制限を超過しているものの当該制限値及び実際値</li> </ol>                 東京空港事務所環境・地域振興課                  FAX : 03-5756-1511(+81-3-5756-1511)                  E メール : hnd-kantika1596@mliit.go.jp             </li> </ul> </li> <li>4. 滑走路 04 は滑走路 05、滑走路 16L/16R 及び滑走路 34R が使用できない場合に使用する。</li> </ol>	<ol style="list-style-type: none"> <li>1. RWY05(north wind operation applied) or RWY16L(south wind operation applied) is preferentially used.</li> <li>2. When RWY05 and RWY16L are not available, RWY16R is used.</li> <li>3. RWY34R is available only when north wind operation applied, under following a. or b.circumstance, and RWY16L/R does not suit for safe take-off. However, in each case, all aircraft should take off with 2,500m RWY length from RWY34R threshold and keep its weight, main gear load and wheel load, on departure, at or below the limitations for RWY05/23(see RJTT AD2.23.7). (Because RWY34R is used as a substitute for RWY05.) However this does not apply to flights that is specified and allowed in advance in consideration of the performance and route distance, etc. "Specified flights". In this case, all specified aircraft should take off with 3,000m RWY length from RWY34R threshold.             <ol style="list-style-type: none"> <li>a. RWY05 is closed.</li> <li>b. The wind condition on departure exceeds crosswind or tailwind take-off limitations of RWY05.</li> </ol> <ul style="list-style-type: none"> <li>*Aircraft departing from RWY05 or landing to RWY34R have priority over the aircraft which departs from RWY34R due to 3.b. above.</li> <li>*No aircraft shall depart from RWY34R only because of being over the aircraft weight restriction of RWY05/23 (RJTT AD2.23.7).</li> <li>*As for 3.b. above, when take off from RWY34R beyond reasonable level is made, suspending/deleting the item(3.b.) , or other appropriate measures will be implemented.</li> <li>*Except specified flight, the operator of the aircraft which has made take-off from RWY34R, shall report following information to Environment and Regional Development Division Tokyo international airport office.                 <ol style="list-style-type: none"> <li>a) date and time of the take-off</li> <li>b) call-sign and type of the aircraft</li> <li>c) weight and balance data of the aircraft on the departure</li> <li>d) reason for using RWY34R (RWY05 closed/tailwind limitation/crosswind limitation)</li> <li>e) wind direction and wind velocity</li> <li>f) runway conditions (wet/dry, etc.)</li> <li>g) other informations concerning</li> </ol>                 if the take-off is made due to 3.b. above, following item h) shall be added,                 <ol style="list-style-type: none"> <li>h) limitation and actual value of crosswind and/or tailwind on the departure which conflicts take-off limit</li> </ol>                 Environment and Regional Development Division                  Tokyo International Airport Office                  FAX: 03-5756-1511(+81-3-5756-1511)                  e-mail: hnd-kantika1596@mliit.go.jp             </li> </ul> </li> <li>4. RWY04 is used when RWY05, RWY16L/R and RWY34R are not available.</li> </ol>
--	--	---

(着陸)

(For Landing)

From 2100UTC to 1400UTC	<ol style="list-style-type: none"> <li>1. 滑走路 34L 及び 34R (北風運用時)、又は、滑走路 22 及び 23 (南風運用時) を優先的に使用する。ただし、0600UTC から 1000UTC の南風運用時は除く。(*1)</li> <li>2. 2100UTC から 0600UTC まで、及び 1000UTC から 1400UTC までは、滑走路 16L は、概ね 20 ノット以上の南東強風時、又は、滑走路 22 が使用できない場合 (滑走路 23 が使用できない場合であって、滑走路 22 では対応が不可能な場合を含む。) に使用する。</li> </ol>	<ol style="list-style-type: none"> <li>1. RWY34L and 34R (north wind operation applied) or, RWY22 and 23 (south wind operation applied) are preferentially used. Except during south wind operation from 0600UTC to 1000UTC. (*1)</li> <li>2. From 2100UTC to 0600UTC and from 1000UTC to 1400UTC, RWY16L is used when southeast wind is about 20knots or more, or, when RWY22 is not available (including the case that RWY23 is not available and RWY22 is unsuitable.).</li> </ol>
From 1400UTC to 2100UTC	<ol style="list-style-type: none"> <li>1. 滑走路 34R (北風運用時) 又は滑走路 23 (南風運用時) を優先的に使用する</li> <li>2. 北風運用時において滑走路 34R が使用できない場合、滑走路 34L を使用する。</li> <li>3. 南風運用時において滑走路 23 が使用できない場合は、滑走路 16L、滑走路 22 の優先順位により滑走路を使用する。</li> </ol>	<ol style="list-style-type: none"> <li>1. RWY34R(north wind operation applied) or RWY23(south wind operation applied) is preferentially used.</li> <li>2. When north wind operation is applied, and RWY34R is not available, RWY34L is used.</li> <li>3. When south wind operation is applied, and RWY23 is not available, RWY16L and RWY22 is used in this order.</li> </ol>

3. 優先飛行経路及び騒音軽減運航方式

航空機が緊急状態又は避けがたい事態にある場合及び NOTAM に別段の定めがある場合を除き、次の運航方式がすべての航空機に適用される。ただし、航空機の安全な運航を確保するために必要な操縦者の職務権限と責任の遂行を妨げるものではない。

3. Preferential Routes and Aircraft Operating Procedures for Noise Abatement

Except in the event an aircraft is in an emergency, an unavoidable situation or unless otherwise specified by NOTAMs, the following procedures shall be adhered to by all aircraft. However, none of the procedures herein is intended, in any manner, to abrogate the responsibility of the pilot in command to assure the safe operations of the aircraft.

(離陸)

(For Take off)

From 2100UTC to 1400UTC	RWY 34R	<p>(右旋回離陸)</p> <p>空港の北部、北西部及び北東部にある居住地域における航空機騒音を軽減するため、航空機は次の方式に従わなければならない。</p> <ol style="list-style-type: none"> <li>1. 航空機は各航空会社のフライトマニュアルに規定されているバンク角及び速度により、できるだけ早く旋回を開始しなければならない。</li> <li>2. 2200UTC から 0230UTC 及び 0600UTC から 1000UTC において、RITLA/BEKLA/ROVER [number] B/C Dearture が承認された場合、急上昇方式もしくは NADP2 が適用される。</li> </ol>	<p>(For right turn departure)</p> <p>In order to minimize public annoyance for aircraft noise in the residential areas located north, northwest and northeast of the airport, the aircraft should comply with following procedures.</p> <ol style="list-style-type: none"> <li>1. Aircraft should commence turns as soon as practicable with bank angles and speeds as prescribed in each operator's flight manuals.</li> <li>2. From 2200UTC to 0230UTC and From 0600UTC to 1000UTC, when RITLA/BEKLA/ROVER [number] B/C Departure is cleared, Steepest Climb Procedure or NADP2 shall be applied.</li> </ol>
	RWY 34L	<p>(左旋回離陸)</p> <p>空港の北部、北西部及び西部にある居住地域における航空機騒音を軽減するため、航空機は次の方式に従わなければならない。</p> <ol style="list-style-type: none"> <li>1. 航空機は各航空会社のフライトマニュアルに規定されているバンク角及び速度により、できるだけ早く旋回を開始しなければならない。</li> <li>2. インターセクションからの離陸は認められない。</li> </ol>	<p>(For left turn departure)</p> <p>In order to minimize public annoyance for aircraft noise in the residential areas located north, northwest and west of the airport, the aircraft should comply with following procedures.</p> <ol style="list-style-type: none"> <li>1. Aircraft should commence turns as soon as practicable with bank angles and speeds as prescribed in each operator's flight manuals.</li> <li>2. Intersection departure is not permitted.</li> </ol>
	RWY 05	なし	Nil
	RWY 16L	なし	Nil
	RWY 16R	なし	Nil

From 2100UTC to 1400UTC	RWY 04	(右旋回離陸) 空港の北部、北西部及び北東部にある居住地域における航空機騒音を軽減するため、各航空会社のフライトマニュアルに規定されているバンク角及び速度により、できるだけ早く旋回を開始するものとする。		(For right turn departure) In order to minimize public annoyance for aircraft noise in the residential areas located north, northwest and northeast of the airport, the aircraft should commence turns as soon as practicable with bank angles and speeds as prescribed in each operator's flight manuals.	
	RWY 22	空港の西部にある居住地域における航空機騒音を軽減するため、航空機は次の方式に従わなければならない。 1. 航空機は各航空会社のフライトマニュアルに規定されているバンク角及び速度により、できるだけ早く旋回を開始しなければならない。 2. 急上昇方式が適用される。 3. 原則として主発動機が4発以上の航空機は運航が認められない。ただし、捜索救難及びVIP機を除く。 4. 以下の機種においては、可能な限り最大離陸推力を使用する。 B777, A330, MD11 5. B777, A330は、原則としてB14/T14からの離陸とする。 6. 使用する機材は、耐空証明における離陸測定点における離陸中の騒音値が89未満であること。(定期便を除く。)		In order to minimize public annoyance for aircraft noise in the residential areas located west of the airport, the aircraft should comply with following procedures. 1. Aircraft should commence turns as soon as practicable with bank angles and speeds as prescribed in each operator's flight manual. 2. Steepest Climb Procedure shall be applied. 3. In principle, aircraft with 4 or more main engines are not allowed to operate. Excluding search and rescue and VIP aircraft. 4. In the following models, using the maximum takeoff thrust as much as possible. B777, A330, MD11 5. In principle, B777, A330 should use intersection B14/T14 for takeoff. 6. The noise level (EPNdB) during takeoff at flyover reference noise measurement point in the airworthiness certification shall be less than 89. (Excluding Scheduled flights.)	
From 1400UTC to 2100UTC	RWY 05	「OPPAR DEPARTURE」 (代替方式無し)	空港の北部及び北東部にある居住地域における航空機騒音を軽減するため、各航空会社のフライトマニュアルに規定されているバンク角及び速度により、できるだけ早く旋回を開始するものとする。	[OPPAR DEPARTURE] (Not alternate procedures)	In order to minimize public annoyance for aircraft noise in the residential areas located north and northeast of the airport, the aircraft should commence turns as soon as practicable with bank angles and speeds as prescribed in each operator's flight manuals.
	RWY 16L		なし		Nil
	RWY 16R		なし		Nil
	RWY 34R		空港の北部、北西部及び北東部にある居住地域における航空機騒音を軽減するため、各航空会社のフライトマニュアルに規定されているバンク角及び速度により、できるだけ早く旋回を開始するものとする。		In order to minimize public annoyance for aircraft noise in the residential areas located north, northwest and northeast of the airport, the aircraft should commence turns as soon as practicable with bank angles and speeds as prescribed in each operator's flight manuals.
	RWY 04		空港の北部、北西部及び北東部にある居住地域における航空機騒音を軽減するため、各航空会社のフライトマニュアルに規定されているバンク角及び速度により、できるだけ早く旋回を開始するものとする。		In order to minimize public annoyance for aircraft noise in the residential areas located north, northwest and northeast of the airport, the aircraft should commence turns as soon as practicable with bank angles and speeds as prescribed in each operator's flight manuals.

(着陸)

1. 住居地域における航空機騒音を軽減するため、脚下げは運航上可能な限り遅く操作するものとする。特に、滑走路 22ILS 進入を使用する場合は IAD から 6.3 海里の地点まで住居が密集していることに留意すること。
2. 1300UTC から 2200UTC まではディレイド・フラップ進入方式によるものとする。

(For Landing)

1. In order to reduce aircraft noise in the residential area, gear-down should be delayed as far as operationally practicable. Especially, when using RWY22 ILS approach, pay attention that residences are dense until 6.3NM from IAD.
2. Between the hours of 1300UTC and 2200UTC, aircraft should perform Delayed Flap Approach Procedure.

From 2100UTC to 1400UTC	RWY 34R	「HIGHWAY VISUAL RWY34R」が優先的に使用される。 「ILS Z or LOC Z RWY34R」は「HIGHWAY VISUAL RWY34R」が使用できない場合に限り使用される。	[HIGHWAY VISUAL RWY34R] is primarily applied. [ILS Z or LOC Z RWY34R] is applied only when [HIGHWAY VISUAL RWY34R] is not applicable.
	RWY 34L	「ILS X or LOC X RWY34L」が優先的に使用される。 「ILS Z or LOC Z RWY34L」は「ILS X or LOC X RWY34L」が使用できない場合に限り使用される。	[ILS X or LOC X RWY34L] is primarily applied. [ILS Z or LOC Z RWY34L] is applied only when [ILS X or LOC X RWY34L] is not applicable.
From 2100UTC to 1400UTC	RWY 22	「LDA W RWY22」が優先的に使用される。 (4. 騒音軽減進入方式を参照) 「LDA W RWY22」が使用できないときには、「LDA Z(X) RWY22」、「ILS RWY22」、「LOC RWY22」の順に使用される。	[LDA W RWY22] is primarily applied. (See 4.Noise Abatement Approach Procedure) When [LDA W RWY22] is not available, [LDA Z(X) RWY22], [ILS RWY22] and [LOC RWY22] is used in this order.
	RWY 23	「LDA W RWY23」が優先的に使用される。 (4. 騒音軽減進入方式を参照) 「LDA W RWY23」が使用できないときには、「LDA Z(X) RWY23」、「ILS Z RWY23」、「LOC Z RWY23」の順に使用される。	[LDA W RWY23] is primarily applied. (See 4.Noise Abatement Approach Procedure) When [LDA W RWY23] is not available, [LDA Z(X) RWY23], [ILS Z RWY23] and [LOC Z RWY23] is used in this order.
	RWY 16L	2100UTC から 0600UTC まで、及び 1000UTC から 1400UTC までは、空港の北部にある居住地域における航空機騒音を軽減するため、航空機は最終進入への旋回の間、付図に示すコースに沿って又はその内側を飛行しなければならない。 0600UTC から 1000UTC まで、「RNAV RWY16L」が優先的に使用される。(*2) 「ILS RWY16L」は「RNAV RWY16L」が使用できない場合に限り使用される。	From 2100UTC to 0600UTC and From 1000UTC to 1400UTC, in order to minimize public annoyance for aircraft noise in the residential areas located north of the airport, aircraft should fly along or inside of the course shown in attached chart during the circling to final.  From 0600UTC to 1000UTC, [RNAV RWY16L] is primarily applied.(*2) [ILS RWY16L] is applied only when [RNAV RWY16L] is not applicable.
	RWY 16R	0600UTC から 1000UTC まで、「RNAV RWY16R」が優先的に使用される。(*2) 「ILS RWY16R」は「RNAV RWY16R」が使用できない場合に限り使用される。	From 0600UTC to 1000UTC, [RNAV RWY16R] is primarily applied.(*2) [ILS RWY16R] is applied only when [RNAV RWY16R] is not applicable.
From 1400UTC to 2100UTC	RWY 34R	「ILS Y or LOC Y RWY34R」(via OSHIMA NIGHT ARRIVAL, AKSEL NIGHT ARRIVAL, AROSA NIGHT ARRIVAL or MESSE NIGHT ARRIVAL)	[ILS Y or LOC Y RWY34R] (via OSHIMA NIGHT ARRIVAL, AKSEL NIGHT ARRIVAL, AROSA NIGHT ARRIVAL or MESSE NIGHT ARRIVAL)
	RWY 34L	「ILS Y or LOC Y RWY34L」(via OSHIMA NIGHT ARRIVAL, AKSEL NIGHT ARRIVAL, AROSA NIGHT ARRIVAL or MESSE NIGHT ARRIVAL) リバーススラスト 空港周辺の航空機騒音を軽減するため、滑走路 34L 着陸後のリバーススラスト使用についてはアイドルパワーまでとする。	[ILS Y or LOC Y RWY34L] (via OSHIMA NIGHT ARRIVAL, AKSEL NIGHT ARRIVAL, AROSA NIGHT ARRIVAL or MESSE NIGHT ARRIVAL)  Reverse Thrust In order to reduce aircraft noise in the vicinity of the airport, pilots are requested to limit the use of reverse thrust to idle power after landing at RWY34L.
	RWY 22	「LDA Y RWY22」(via OSHIMA NIGHT ARRIVAL, AKSEL NIGHT ARRIVAL, AROSA NIGHT ARRIVAL or MESSE NIGHT ARRIVAL) リバーススラスト 空港周辺の航空機騒音を軽減するため、滑走路 22 着陸後のリバーススラスト使用についてはアイドルパワーまでとする。	[LDA Y RWY22] (via OSHIMA NIGHT ARRIVAL, AKSEL NIGHT ARRIVAL, AROSA NIGHT ARRIVAL or MESSE NIGHT ARRIVAL)  Reverse Thrust In order to reduce aircraft noise in the vicinity of the airport, pilots are requested to limit the use of reverse thrust to idle power after landing at RWY22.

From 1400UTC to 2100UTC	RWY 23	「LDA Y RWY23」(via OSHIMA NIGHT ARRIVAL, AKSEL NIGHT ARRIVAL, AROSA NIGHT ARRIVAL or MESSE NIGHT ARRIVAL)が優先的に使用される。 「ILS Y or LOC Y RWY23」(via OSHIMA NIGHT ARRIVAL, AKSEL NIGHT ARRIVAL, AROSA NIGHT ARRIVAL or MESSE NIGHT ARRIVAL)は「LDA Y RWY23」が使用できない場合に限り使用される。	[LDA Y RWY23] (via OSHIMA NIGHT ARRIVAL, AKSEL NIGHT ARRIVAL, AROSA NIGHT ARRIVAL or MESSE NIGHT ARRIVAL) is primarily applied.  [ILS Y or LOC Y RWY23] (via OSHIMA NIGHT ARRIVAL, AKSEL NIGHT ARRIVAL, AROSA NIGHT ARRIVAL or MESSE NIGHT ARRIVAL) is applied only when [LDA Y RWY23] is not applicable.
	RWY 16L	「VOR A」(via OSHIMA V ARRIVAL, AKSEL V ARRIVAL, AROSA V ARRIVAL or MESSE V ARRIVAL) 空港の北部にある居住地域における航空機騒音を軽減するため、航空機は最終進入への旋回の間、付図に示すコースに沿って又はその内側を飛行しなければならない。	[VOR A] (via OSHIMA V ARRIVAL, AKSEL V ARRIVAL, AROSA V ARRIVAL or MESSE V ARRIVAL)  In order to minimize public annoyance for aircraft noise in the residential areas located north of the airport, aircraft should fly along or inside of the course shown in attached chart during the circling to final.

(\*1) 0600UTC から 1000UTC のうちの 3 時間程度にあつては、南風運用時において以下の滑走路が使用される。  
(離陸) RWY16R, RWY16L, RWY22  
(着陸) RWY16R, RWY16L

(\*1) For about 3 hours from 0600UTC to 1000UTC, the following runway is used during the south wind operation.  
(For Take off) RWY16R, RWY16L, RWY22  
(For Landing) RWY16R, RWY16L

(\*2) 0600UTC から 1000UTC のうちの 3 時間程度であつて、上記(\*1)の滑走路が使用される場合に適用される。

(\*2) Applicable when the runway (\*1) is used in about 3 hours from 0600UTC to 1000UTC.

#### 4. 騒音軽減進入方式 (NAAP)

- (1) 適用時間帯  
2100UTC から 1400UTC の間
- (2) 対象航空機  
BACON 経由滑走路 22 及び DATUM 経由滑走路 23 に着陸する航空機  
(レーダー誘導により LDA22 又は LDA23 ローカライザーコースへ会合するものを除く。)
- (3) 対象経路  
LDA W RWY22 及び LDA W RWY23
- (4) 実施条件  
台風等の悪天候、レーダー施設の障害等の重大な事象がないこと。
- (5) NAAP の承認  
管制機関は LDA W RWY22 又は LDA W RWY23 による進入を許可することにより、NAAP を承認する。
- (6) 継続的な降下 (LDA W RWY22 のみ)  
NAAP 実施中は、不必要な TCAS-RA の発生を避けるとともに、騒音軽減のため、航空機は BACON と BEAST の間を 1500FT /min を超えない降下率で継続的に降下しなければならない。
- (7) NAAP が実施できない場合  
悪天候などの理由により NAAP が実施できない場合には、航空機は東京アプローチとの通信設定時に、その理由とともに LDA Z RWY22 又は LDA Z RWY23 若しくはその他の進入方式を要求しなければならない。
- (8) NAAP の中止  
交通状況等により、管制機関は承認した NAAP を中止することがある。その場合、代替指示が発出される。
- (9) その他  
交通状況もしくは気象状態等によって、管制機関は進入方式上の速度と異なる速度を指示することがある。

#### 4. Noise Abatement Approach Procedure(NAAP)

- 1) Applicable time  
Between 2100UTC and 1400UTC
- 2) Aircrafts NAAP is applied  
All aircraft which land to RWY22 via BACON/RWY23 via DATUM of Tokyo INTL Airport. (except aircraft intercepting LDA22/LDA23 LOC course by RADAR vector)
- 3) Routes used for NAAP  
LDA W RWY22 and LDA W RWY23
- 4) Conditions  
No significant condition such as Typhoon, Severe WX conditions, or Malfunction of radar system etc. is observed.
- 5) Clearance for NAAP  
ATC clears NAAP by assigning approach procedure of "LDA W RWY22" or "LDA W RWY23".
- 6) Continuous descent(only LDA W RWY22)  
To avoid nuisance TCAS-RA and reduce noise, while conducting NAAP, pilot should make descent continuously with 1500FT/min or less descending rate between BACON and BEAST.
- 7) In case NAAP is not available  
If NAAP is not available because of WX conditions etc, pilot should request LDA Z RWY22/LDA Z RWY23 or other approach with the reason at initial contact with Tokyo Approach.
- 8) Cancellation of NAAP  
ATC may cancel NAAP due to traffic conditions even after NAAP is cleared. In this case, alternate instructions will be issued.
- 9) Remarks  
Due to traffic or WX conditions, ATC may assign IAS differing from on attached.

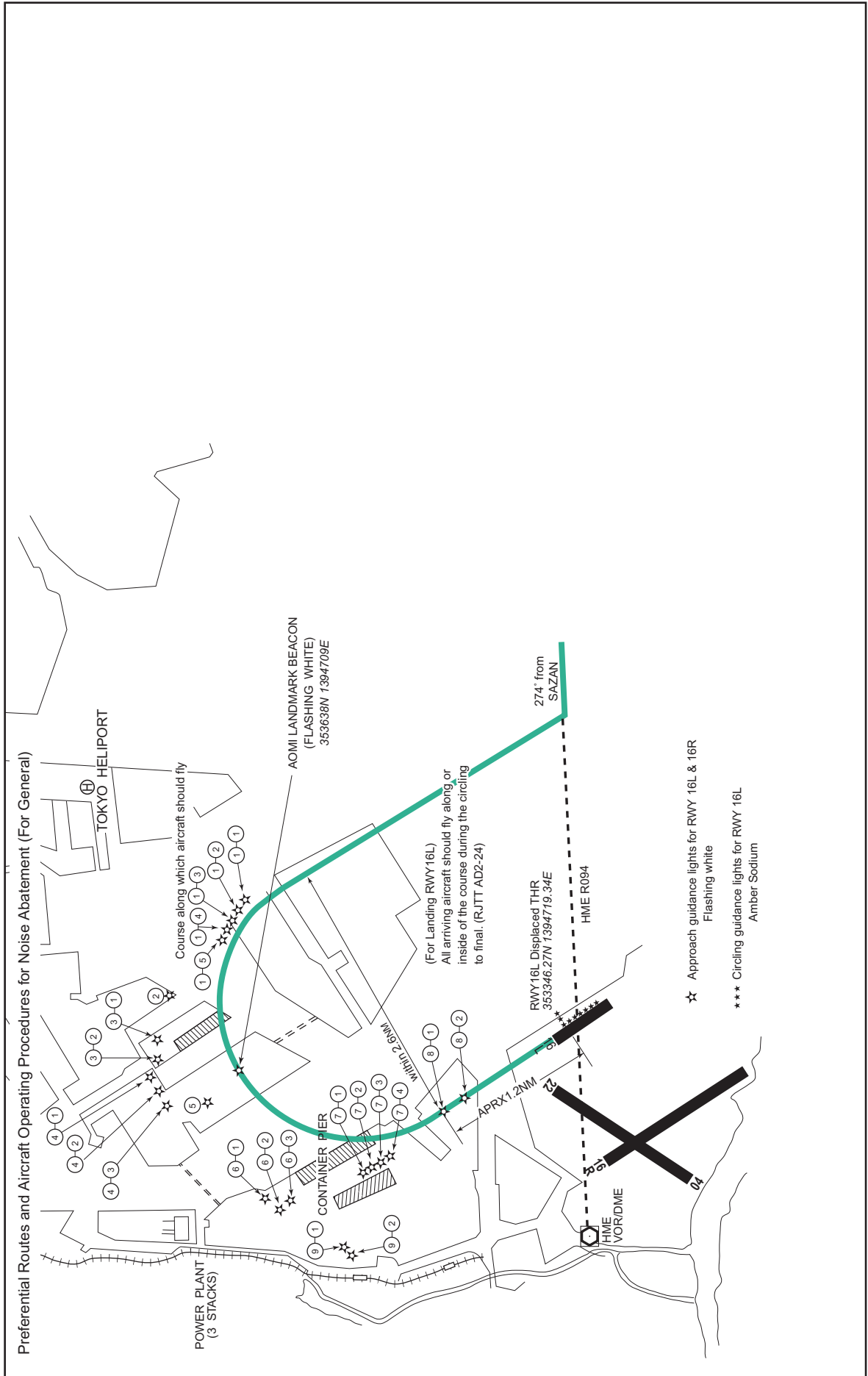

## RJTT AD 2.22 FLIGHT PROCEDURES

## 1. TAKE OFF MINIMA

	RWY	ACFT CAT	REDL & RCLL		REDL or RCLL or RCL Marking		NIL (DAYTIME ONLY)	
			RVR	VIS	RVR	VIS	RVR	VIS
Multi-Engine ACFT with TKOF ALTN AP FILED	04	A,B,C,D	-	400m	-	400m	-	500m
	22	A,B,C,D	400m	400m	400m	400m		
	05	A,B,C,D	400m	400m	400m	400m		
	16R	A,B,C,D	400m	400m	400m	400m		
	34L	A,B,C,D	400m	400m	400m	400m		
	16L	A,B,C	400m **200m ***150m	400m **200m	400m **250m	400m **250m		
		D	400m **250m ***200m	400m **250m	400m **300m	400m **300m		
	34R	A,B,C	400m **200m ***150m	400m **200m	400m **250m	400m **250m		
		D	400m **250m ***200m	400m **250m	400m **300m	400m **300m		
	OTHER	04 22 05 16R 34L 16L 34R	A,B,C,D	AVBL LDG MINIMA				

\*\*APPLICABLE WHEN SSP IN FORCE

\*\*\*APPLICABLE WHEN SSP IN FORCE and MULTIPLE RVRs AVAILABLE

## 2. Trajectory Airport Traffic Data Processing System (TAPS)

東京アプローチの指示のもとに、当該進入管制区を飛行する航空機は、モード A/3 の二次レーダー個別コード及びモード C による応答を指示される。

二次レーダー個別コードを搭載していない航空機が当該コードによる応答を指示された場合は、管制官に対し、その旨通報すること。

Aircraft flying under control of Tokyo approach control in the approach control area will be instructed to reply with discrete code on Mode A/3 and Mode C.

If an aircraft with non-discrete code capability be instructed to reply with the discrete code, it shall report a controller accordingly.

## 3. Lost communication procedures for arrival aircraft under radar navigational guidance

If radio communications with Tokyo Approach/Radar are lost for 1 minute, squawk Mode A/3 Code 7600 and;

- (I)
  - 1) Contact TOKYO Tower.
  - 2) If unable, proceed in accordance with visual flight rules.
  - 3) If unable,
    - a) When RWY34L or RWY34R in use, proceed to SINGO at last assigned altitude or 4,000feet whichever is higher, and execute instrument approach for RWY34R.
    - b) When RWY22, RWY23, RWY16L or RWY16R in use, proceed to SMILE at last assigned altitude or 4,000feet whichever is higher, and execute instrument approach for RWY23.
- (II) Procedures other than above will be issued when situation required.

## 4. Flight restrictions

Unless otherwise authorized by ATC.

Aircraft other than the arriving at and/or departing from Tokyo International Airport are required not to fly over the Kawasaki Petrochemical Complex area, and even in case of flying over the area, not to fly below an altitude of 3,000feet. (See AD2.24 OTHER CHART ATTACHMENT 1)



5. Special VFR flight route for helicopter (See below chart)

## SPECIAL VFR FLIGHT ROUTE FOR HELICOPTER

Special VFR flight route for helicopter in  
the TOKYO Control ZONE

Daishibashi - (along the Tama River) - Marukobashi

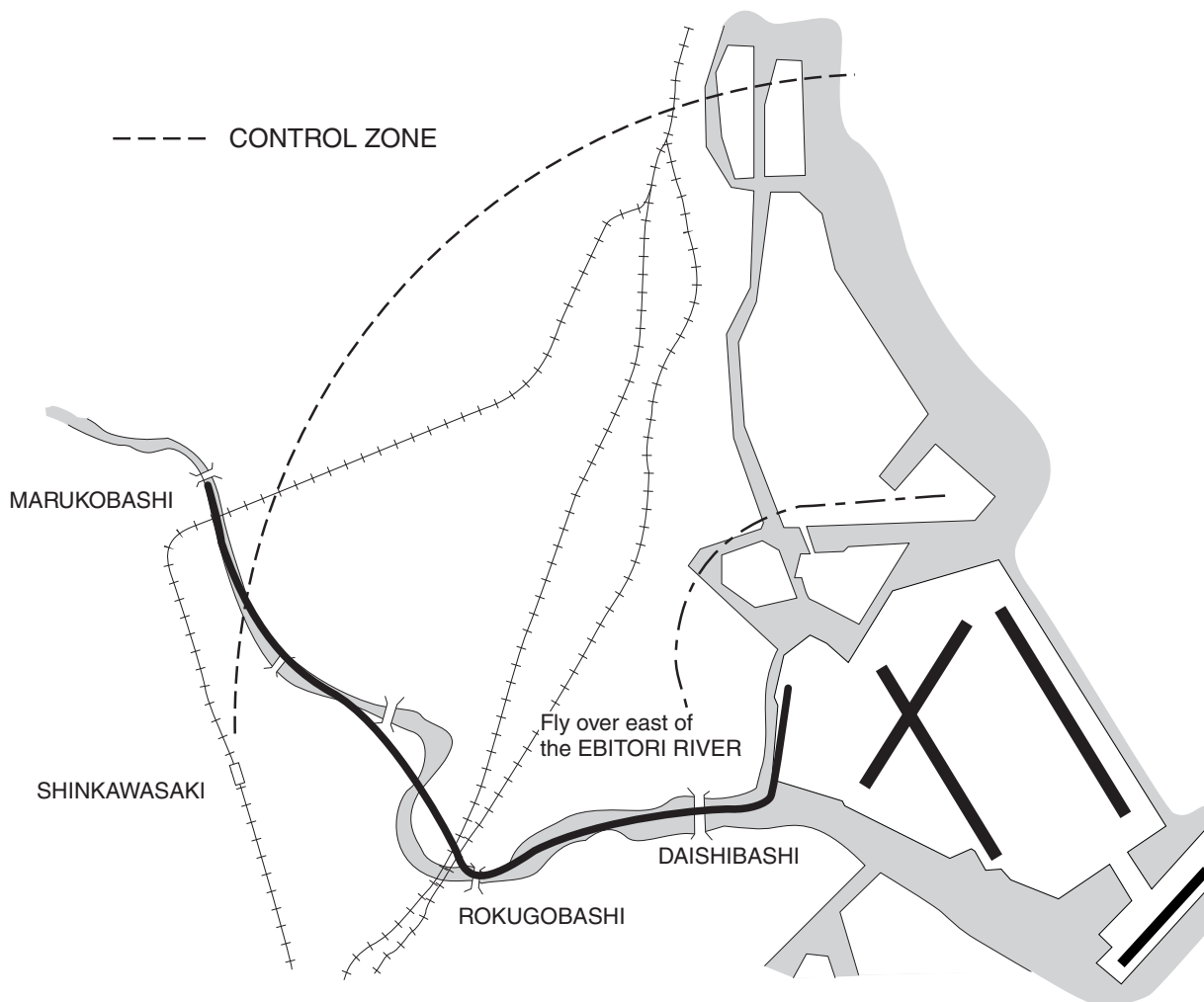

**6. SIMULTANEOUS INDEPENDENT LDA APPROACHES (SILA)**

## 1) Applicable instrument approach procedures for SILA

LDA W RWY22(with VPT), LDA W RWY23(with VPT), LDA Z RWY22(with VPT), LDA Z RWY23(with VPT), LDA X RWY22(with VPT) and LDA X RWY23(with VPT)

Note: "VPT" stands for Visual maneuver with Prescribed Track that meets the criteria of ICAO PANS-OPS (Doc.8168).  
A specific track for visual maneuvering after the MAPt is prescribed in these procedures.

## 2) Conditions

SILA, where radar separation minima between aircrafts on adjacent localizer courses and VPTs are not prescribed, will be conducted when the following conditions are met. However, SILA shall not be applied under certain adverse weather conditions which might affect safe operations (e.g. windshear on the final approach course, etc.).

- A. No Transgression Zone (NTZ) 610m wide is established equidistant between localizer courses and is depicted on the radar display.
- B. LOC, radar, and appropriate frequencies are operating normally.

Note: Visual aids associated with the runway used for the prescribed track (i.e. ALS, PAPI) are shown on the chart with their main characteristics (i.e. slope of the PAPI).

## 3) Information of SILA

Aircraft shall be advised that SILA are in force. This information may be provided through the ATIS broadcasts.

"Simultaneous LDA approaches to RWY22 and RWY23 are in progress."

## 4) Radar monitoring

Radar monitoring is provided for each simultaneous LDA approach to ensure aircraft do not deviate from the localizer course as follows;

- A. Aircraft shall be provided a minimum of 1,000ft vertical separation or a minimum of 3NM radar separation until intercepting localizer course.  
The assigned altitude shall be maintained until final approach fix (FAF).
- B. Radar monitoring is continued even after instructed to contact Tower frequency and instructions prescribed in C are provided on the frequency when necessary.
- C. Aircraft observed to overshoot the turn-on or continue on a track which will penetrate the NTZ will be instructed to return to the correct localizer course. If a deviating aircraft fails to respond to such instructions or is observed penetrating the NTZ, the aircraft on the adjacent localizer course shall be instructed to avoid the deviating aircraft.
- D. Radar monitoring will automatically be terminated when the aircraft has passed the coverage of NTZ (RWY22: IKL 2.7DME / RWY23: MAPt).

Note: ATC will not inform pilots when radar monitoring is terminated.

## 5) Go around procedure

When going around, pilot should report ATC as soon as practicable, and proceed in accordance with the go around procedure described on the chart until receiving ATC instructions.

## 6) Response to "TRAFFIC ALERT"

All breakouts in response to ATC's instructions shall be accomplished quickly. These instructions will be issued on TOWER FREQUENCY when situation required.

## 7. SIMULTANEOUS INDEPENDENT RNAV APPROACHES (SIRA)

### 1) Applicable instrument approach procedures for SIRA

RNAV(GNSS) RWY16L, RNAV(GNSS) RWY16R

### 2) Conditions

SIRA, where radar separation minima between aircrafts on adjacent approach courses are not prescribed, will be conducted when the following conditions are met. However, SIRA shall not be applied under certain adverse weather conditions which might affect safe operations (e.g. windshear on the final approach course, etc.).

- A. No Transgression Zone (NTZ) 610m wide is established equidistant between 16R final approach course and 16L final approach course is depicted on the radar display.
- B. Wide Area Multilateration (WAM), radar and appropriate frequencies are operating normally.
- C. Mode S transponder is activating normally. In case of Mode S transponder which has failed or be not equipped, the pilot should inform the ATC facility.

### 3) Information of SIRA

Aircraft shall be advised that SIRA are in force. This information may be provided through the ATIS broadcasts.

"Simultaneous RNAV approaches to RWY16L and RWY16R are in progress."

### 4) Radar monitoring

Radar monitoring is provided for each simultaneous RNAV approach to ensure aircraft do not deviate from the approach course as follows;

- A. Aircraft shall be provided a minimum of 1,000ft vertical separation or a minimum of 3NM radar separation until the following point;  
: Intersection of an extension line of the north short side of NTZ with RWY 16L/R RNAV approach courses.
- B. Radar monitoring is continued even after instructed to contact Tower frequency and instructions prescribed in C are provided on the frequency when necessary.
- C. Aircraft observed to deviate from the approach course or continue on a track which will penetrate the NTZ will be advised by ATC. If a deviating aircraft is observed penetrating the NTZ, the aircraft on the adjacent approach course shall be instructed to avoid the deviating aircraft.
- D. Radar monitoring will automatically be terminated when visual separation is applied by ATC.

Note: ATC will not inform pilots when radar monitoring is terminated.

### 5) Response to "TRAFFIC ALERT"

All breakouts in response to ATC's instructions shall be accomplished quickly. These instructions will be issued on TOWER FREQUENCY when situation required.

8. Category II / III Operations at Tokyo International Airport

1) Facilities

The following Categories are available:

Runway 34R
(1) ILS Runway 34R-CAT III (2) Lighting system Runway 34R-CAT III (3) RVR by forward-scatter meters (the touchdown zone, the mid-point and stop-end of the runway)

2) Conditions

A. The following systems must be operative:

For ILS Z RWY34R approach (CAT II) For ILS Y RWY34R approach (CAT II)	For ILS Z RWY34R approach (CAT III) For ILS Y RWY34R approach (CAT III)
(1) ILS comprising; • ILS-LOC 34R with standby transmitter • ILS-GP 34R with standby transmitter (When any standby transmitters unserviceable, downgrade ILS-CAT I.) • IM 34R (When IM unserviceable, RA could be used as an alternate method.) • ILS-DME 34R	(1) ILS comprising; • ILS-LOC 34R with standby transmitter (including far field monitor) • ILS-GP 34R with standby transmitter (When any standby transmitters or far field monitor unserviceable, downgrade ILS-CAT I.) • ILS-DME 34R
(2) Lighting systems comprising; • PALS 34R (including side row barrettes) • High INTST REDL • High INTST RTHL • RCLL and RTZL	(2) Lighting systems comprising; • PALS 34R (including side row barrettes) • High INTST REDL • High INTST RTHL • RCLL and RTZL
(3) Secondary power supply	(3) Secondary power supply
(4) RVR by forward-scatter meters at the touchdown zone and either (the mid-point or stop-end of the runway).	(4) RVR by forward-scatter meters at the touchdown zone, mid-point and stop-end of the runway.

B. The following information must be currently available:

- 1) Surface wind speed and direction
- 2) RVR

C. ITEM A and/or B are not met, the relevant information will be notified to the pilots as soon as practicable.

3) Operating Minimum

Approach minima stated AD2.24 (Instrument Approach Chart) are observed.

4) Special Safeguards and Procedures (SSP)

CAT II / III Operations are available when SSP are applied.

SSP will be applied when the following conditions are met:

- 1) Ceiling is at or less than 200ft and/or RVR is at or less than 600m.
- 2) Facilities listed 1) above are operational.
- 3) ILS Critical Area is protected.

In order to protect Critical Area for the succeeding arrival aircraft, an arrival aircraft may be given the following instruction by ATC:

**“REPORT OUT OF ILS CRITICAL AREA”**

The exit taxiway center line lights are fixed alternate green and yellow inside the ILS Critical Area. If an aircraft is given the above instruction, she is expected to advise the ATC when the taxiway center line lights change from alternate green and yellow to steady green.

5) Approval for CAT II / III Operations

Operators must obtain operational approval from the State of Registry or the State of Operator, as appropriate, to conduct CAT II / III Operations. (See GEN1.5)

**RJTT AD 2.23 ADDITIONAL INFORMATION**

1. TV tower  
TV tower 1,148 feet MSL located 6NM NNW of HANEDA VOR/DME (HME)
2. Vehicle traffic line  
White line markings on apron area.
3. Schedule maintenance on the runway  
All RWY are subject to closing for maintenance purpose as follows. See NOTAM RJTT for further detailed information.

FACILITY	PLANNING PERIOD	REMARKS
RWY 16R/34L	MON, WED, THU, SAT, SUN 1400-2130	AVBL CROSS RWY 16R/34L VIA TWY OTHER THAN CLSD TWY
RWY 04/22	MON, TUE, THU, FRI, SUN 1430-2100	AVBL CROSS RWY 04/22 VIA TWY OTHER THAN CLSD TWY
RWY 16L/34R	TUE, FRI 1530-2130	
RWY 05/23	WED 1430-2100 SAT 1700-2100	

4. Bird-patrollers will patrol on perimeter and/or maintenance road around RWYs and occasionally use shotgun and shell crackers to get rid of birds harmful to air safety. Bird-patrollers may enter LDG strips not nearer than 50M FM RWY edges and 20M FM TWY edges to pick up birds being shot down HJ.
5. Positions not visible from control tower.
  - a) Aircraft stand  
From NR201 to NR205.
  - b) Taxiway  
A part of TWY A(from spot NR201 to spot RU6) and a part of TWY W(from spot NR201 to NR203).

6. 空港付近の船舶の航行

- 6.1 RWY04/22 及び RWY05/23 の北東側に船舶高基準面と許容高が設定される。
- 6.2 航空機の運航に影響がある高さの船舶が、RWY22 または RWY23 の進入表面下を航行することがあり、これらの船舶は空港当局により監視されている。必要に応じて以下の対応が取られる。  
(添付図参照)

東京西航路

- 1) 当該進入表面下に設定された東京西航路を航行する船舶の情報は、RJTT NOTAM または ATC により提供される。
- 2) 船舶が A 点と B 点または C 点と D 点の間を通過する間、下記の制限がかかる。
  - a) RWY04 及び RWY05 からの離陸は許可されない。
  - b) RWY22 及び RWY23 への到着機に対して空中待機または復行が指示されることがある。

側傍海域

船舶が、東京西航路と進入灯の間の進入表面下を通過する場合には、船舶の高さ及び位置により、以下の制限がかかる。

- a) RWY04 及び RWY05 からの離陸は許可されない。
- b) RWY22 及び RWY23 への到着機に対して復行が指示されることがある。

6. Passage of vessel in the vicinity of the airport

- 6.1 Base level of Vessel height and Admissible height is set at Northeast side of RWY 04/22 or RWY 05/23.
- 6.2 The Vessel with height which affects aircraft operations may pass across beneath the approach surface of RWY22 or RWY23, and those vessels are monitored by Airport authority. The following action will be taken when necessary.  
(see attached chart)

Tokyo West Passage Route

- (1) The information of the vessel passing along the Tokyo West Passage Route, which is laid down beneath the approach surfaces, will be provided by NOTAM RJTT or ATC.
- (2) While the vessel is between point A and B or between point C and D, following restrictions are taken;
  - a) Take-off clearance is not issued for RWY04 or RWY05.
  - b) Holding or Go-around instruction may be issued for arrival aircraft for RWY22 or RWY23.

Adjacent sea area

When a vessel passes across beneath approach surface between approach lights and Tokyo West Passage Route, depending on height and position of the vessel, following restrictions are taken;

- a) Take-off clearance is not issued for RWY04 or RWY05.
- b) Go-around instruction may be issued for RWY22 or RWY23.

(断面図)

- 航空機の運航に影響がある高さの船舶：側傍海域にあっては、N.H.H.W.L + 24.0m以上の船舶
- 東京西航路にあっては、N.H.H.W.L + 56.3m以上の船舶
- N.H.H.W.L：満潮時でこれより高くならないと想定される潮位

(profile view)

- The Vessel height which affects aircraft operations adjacent sea area : Vessel height is at or above N.H.H.W.L + 24.0m
- Tokyo West Passage Route : Vessel height is at or above N.H.H.W.L + 56.3m
- N.H.H.W.L: Nearly Highest High Water Level

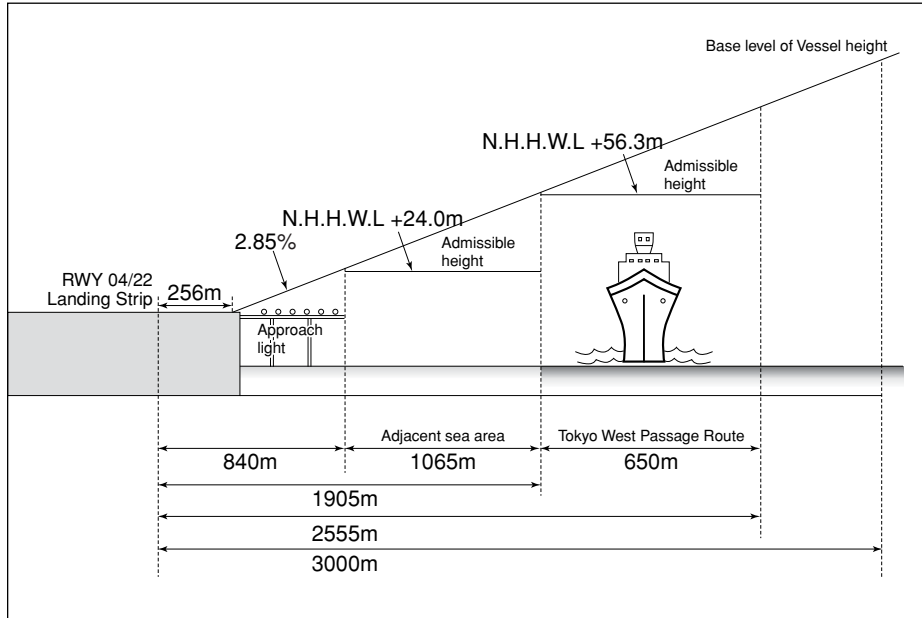

(断面図)

- 航空機の運航に影響がある高さの船舶：側傍海域にあっては、N.H.H.W.L + 28.4m以上の船舶
- 東京西航路にあっては、N.H.H.W.L + 53.7m以上の船舶
- N.H.H.W.L：満潮時でこれより高くならないと想定される潮位

(profile view)

- The Vessel height which affects aircraft operations adjacent sea area: Vessel height is at or above N.H.H.W.L + 28.4m
- Tokyo West Passage Route : Vessel height is at or above N.H.H.W.L + 53.7m
- N.H.H.W.L: Nearly Highest High Water Level

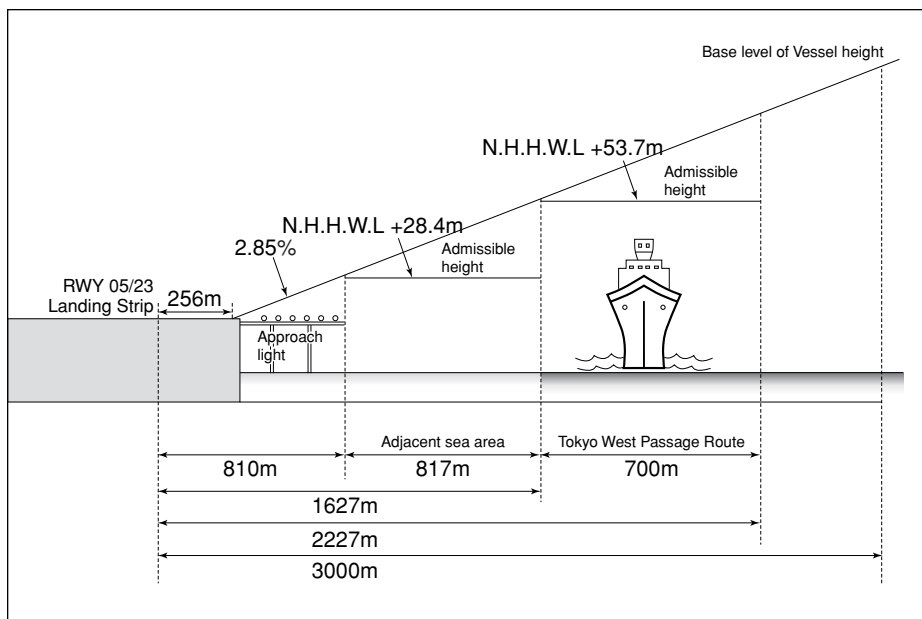

### Tokyo West passage Route and Adjacent sea area

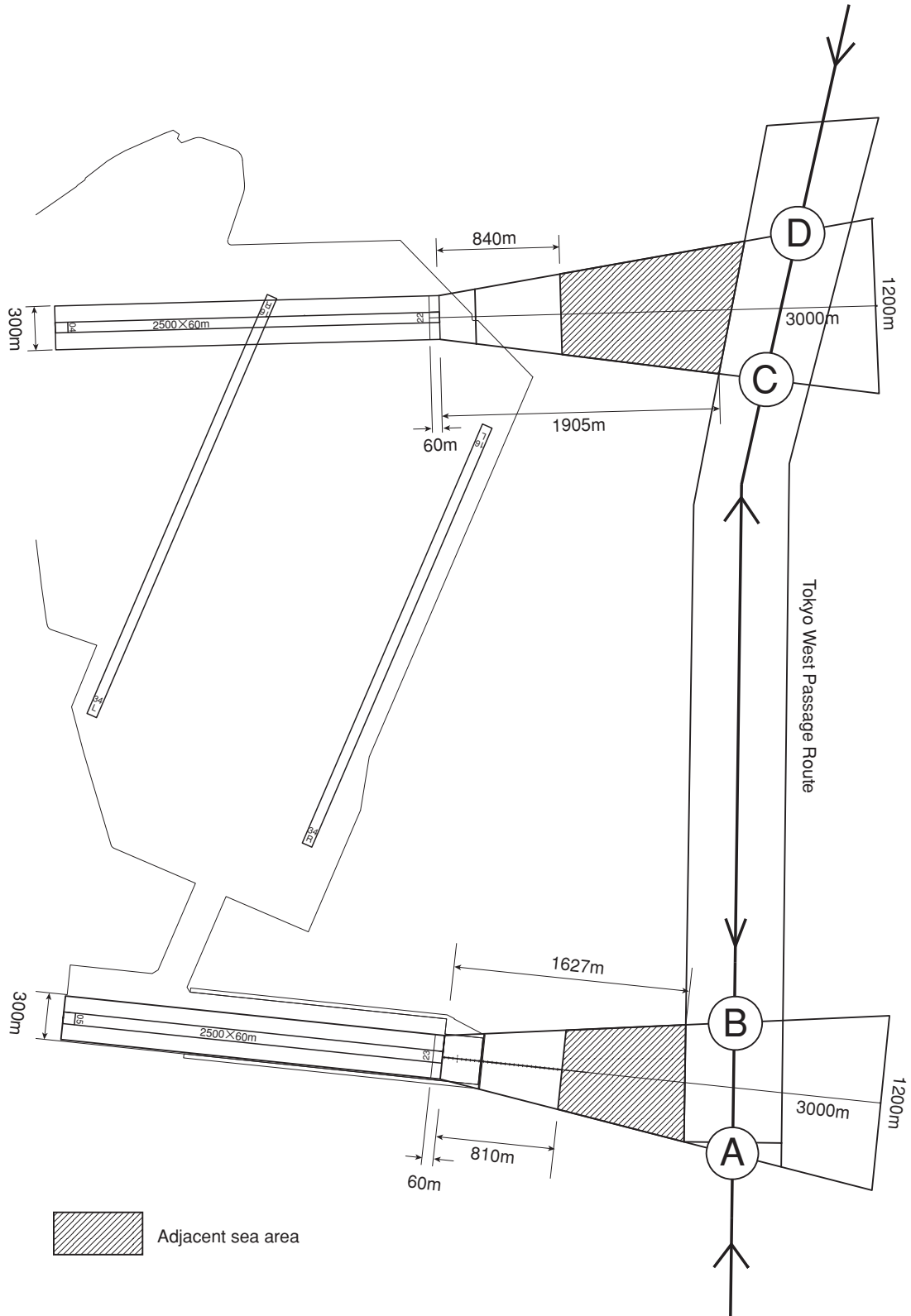

7. 航空機重量制限

滑走路 05/23 を使用する航空機においては、航空機重量、主脚荷重及び輪荷重の全てが下表の値を超えてはならない。

航空機重量		主脚荷重		輪荷重	
(lb)	(kg)	(lb/脚)	(kg/脚)	(lb/輪)	(kg/輪)
881,800	400,000	307,500	139,500	57,700	26,200

注) RJTT AD2.20.1.2 LOCAL TRAFFIC REGULATIONS (3), (11) 及び AD2.21.2 Noise Preferential Runways を参照

誘導路 Q を使用する航空機においては、コード D までの航空機（翼幅が 52m 未満）の使用に限ることとし、航空機重量、主脚荷重及び輪荷重の全てが下表の値を超えてはならない。

航空機重量		主脚荷重		輪荷重	
(lb)	(kg)	(lb/脚)	(kg/脚)	(lb/輪)	(kg/輪)
570,900	259,000	215,300	97,700	49,100	22,300

8. EMAS (Engineered Materials Arresting Systems)

EMAS, which has high energy-absorbing performance, is located in the overrun area and RESA of the runway. EMAS will exert deceleration force on the landing gear to reduce the damage in case of overrun of an airplane. EMAS is installed with overrun area marking. These systems do not affect the normal landing and takeoff of airplanes.

9. 双方向に設置されている ILS の輻射について

1) ILS 16L / 34R  
SSP 体制時を除き、RWY16L および 34R ILS は同時に輻射する。  
(RJTT AD2.22 8.Category II /III Operations at Tokyo International Airport を参照)

2) ILS 16R / 34L  
RWY16R 運用時を除き、RWY16R および 34L ILS は同時に輻射する。

7. Aircraft weight restriction

When using RWY 05/23, all of the values of aircraft (aircraft weight, main gear load AND wheel load) shall not exceed the values listed in the table below.

Aircraft weight		Main gear load		Wheel load	
(lb)	(kg)	(lb/gear)	(kg/gear)	(lb/wheel)	(kg/wheel)
881,800	400,000	307,500	139,500	57,700	26,200

There are other restrictions for using runway(see RJTT AD2.20.1.2 LOCAL TRAFFIC REGULATIONS (3), (11) and RJTT AD2.21.2 Noise Preferential Runways.).

When passing TWY Q, the wing span of aircraft shall be less than 52m and all of the values of aircraft (aircraft weight, main gear load AND wheel load) shall not exceed the values listed in the table below.

Aircraft weight		Main gear load		Wheel load	
(lb)	(kg)	(lb/gear)	(kg/gear)	(lb/wheel)	(kg/wheel)
570,900	259,000	215,300	97,700	49,100	22,300

9. Two separate ILS radiate at opposite ends of a single runway

1) ILS 16L / 34R  
RWY16L and 34R ILS radiate simultaneously except when SSP are applied.  
(See RJTT AD2.22 8.Category II /III Operations at Tokyo International Airport)

2) ILS 16R / 34L  
RWY16R and 34L ILS radiate simultaneously except when operating RWY16R.



## RJTT AD 2.24 CHARTS RELATED TO AN AERODROME

Aerodrome Chart-1  
Aerodrome Chart-2  
Aircraft Parking/Docking Chart  
Aerodrome Obstacle Chart-ICAO type A (RWY16R/34L)  
Aerodrome Obstacle Chart-ICAO type A (RWY22)  
Aerodrome Obstacle Chart-ICAO type A (RWY04)  
Aerodrome Obstacle Chart-ICAO type A (RWY34R)  
Aerodrome Obstacle Chart-ICAO type A (RWY16L)  
Aerodrome Obstacle Chart-ICAO type A (RWY05/23)  
Aerodrome Obstacle Chart-ICAO type B  
Precision Approach Terrain Chart (RWY34R)  
Standard Departure Chart - Instrument (SEKIYADO)  
Standard Departure Chart - Instrument (VADAR)  
Standard Departure Chart - Instrument (OPPAR)  
Standard Departure Chart - Instrument (ISOGO)  
Standard Departure Chart - Instrument (VAMOS-RNAV)  
Standard Departure Chart - Instrument (LAXAS-RNAV)  
Standard Departure Chart - Instrument (NINOX-RNAV)  
Standard Departure Chart - Instrument (RITLA-A/B/C-RNAV)  
Standard Departure Chart - Instrument (BEKLA-A/B/C-RNAV)  
Standard Departure Chart - Instrument (ROVER-A/B/C-RNAV)  
Standard Departure Chart - Instrument (RUTAS-RNAV)  
Standard Arrival Chart - Instrument (SINGO, DOYLE, ADDUM, BONUS)  
Standard Arrival Chart - Instrument (OSHIMA-1A/1K/2C-RNAV)  
Standard Arrival Chart - Instrument (AKSEL-1A/1K/2C-RNAV)  
Standard Arrival Chart - Instrument (AROSA-1A/1K/2C-RNAV)  
Standard Arrival Chart - Instrument (GODIN -2A/2K/1C-RNAV)  
Standard Arrival Chart - Instrument (POLIX-2A/2K/1C-RNAV)  
Standard Arrival Chart - Instrument (OSHIMA, AKSEL, AROSA-2H-RNAV)  
Standard Arrival Chart - Instrument (GODIN, POLIX-1H-RNAV)  
Standard Arrival Chart - Instrument (OSHIMA-1N/2N-RNAV)  
Standard Arrival Chart - Instrument (OSHIMA-1B/2B-RNAV)  
Standard Arrival Chart - Instrument (AKSEL-1N/2N-RNAV)  
Standard Arrival Chart - Instrument (AKSEL-1B/2B-RNAV)  
Standard Arrival Chart - Instrument (AROSA-1N/2N-RNAV)  
Standard Arrival Chart - Instrument (AROSA-1B/2B-RNAV)  
Standard Arrival Chart - Instrument (GODIN-1S/1D-RNAV)  
Standard Arrival Chart - Instrument (POLIX-1S/1D-RNAV)  
Standard Arrival Chart - Instrument (OSHIMA-L/R-RNAV)  
Standard Arrival Chart - Instrument (AKSEL-L/R-RNAV)  
Standard Arrival Chart - Instrument (AROSA-L/R-RNAV)  
Standard Arrival Chart - Instrument (GODIN-L/R-RNAV)  
Standard Arrival Chart - Instrument (POLIX-L/R-RNAV)  
Standard Arrival Chart - Instrument (OSHIMA, AKSEL, AROSA, MESSE-NIGHT-RNAV)  
Standard Arrival Chart - Instrument (OSHIMA, AKSEL, AROSA, MESSE-V-RNAV)  
Instrument Approach Chart (ILS Z RWY34L)  
Instrument Approach Chart (LOC Z RWY34L)  
Instrument Approach Chart (ILS Y RWY34L)  
Instrument Approach Chart (LOC Y RWY34L)  
Instrument Approach Chart (ILS X RWY34L)  
Instrument Approach Chart (LOC X RWY34L)  
Instrument Approach Chart (VOR RWY34L)  
Instrument Approach Chart (ILS Z RWY34R(CAT II & III))  
Instrument Approach Chart (LOC Z RWY34R)  
Instrument Approach Chart (ILS Y RWY34R(CAT II & III))  
Instrument Approach Chart (LOC Y RWY34R)  
Instrument Approach Chart (ILS RWY22)  
Instrument Approach Chart (LOC RWY22)  
Instrument Approach Chart (LDA Z RWY22)  
Instrument Approach Chart (LDA Y RWY22)  
Instrument Approach Chart (LDA X RWY22)  
Instrument Approach Chart (LDA W RWY22)  
Instrument Approach Chart (ILS Z RWY23)  
Instrument Approach Chart (LOC Z RWY23)  
Instrument Approach Chart (ILS Y or LOC Y RWY23)  
Instrument Approach Chart (LDA Z RWY23)  
Instrument Approach Chart (LDA Y RWY23)  
Instrument Approach Chart (LDA X RWY23)

Instrument Approach Chart (LDA W RWY23)  
Instrument Approach Chart (RNAV(RNP) RWY23)  
Instrument Approach Chart (ILS or LOC RWY16R)  
Instrument Approach Chart (RNAV(GNSS) RWY16R)  
Instrument Approach Chart (ILS or LOC RWY16L)  
Instrument Approach Chart (RNAV(GNSS) RWY16L)  
Instrument Approach Chart (VOR A)  
Other Chart (HIGHWAY VISUAL RWY34R)  
Other Chart (HOLDING PATTERN)  
Other Chart (HOLDING PATTERN-RNAV)  
Other Chart (Visual REP)  
Other Chart (MVA CHART)  
Other Chart (LDG CHART)  
Other Chart (Kawasaki Petrochemical Complex(ATTACHMENT-1))

AERODROME CHART

TOKYO INTERNATIONAL AIRPORT  
ELEV 6.4m(21ft)

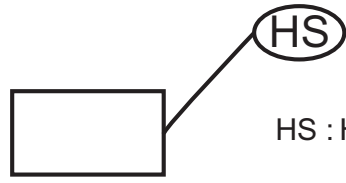

HS : HOT SPOT / See APDC - 1

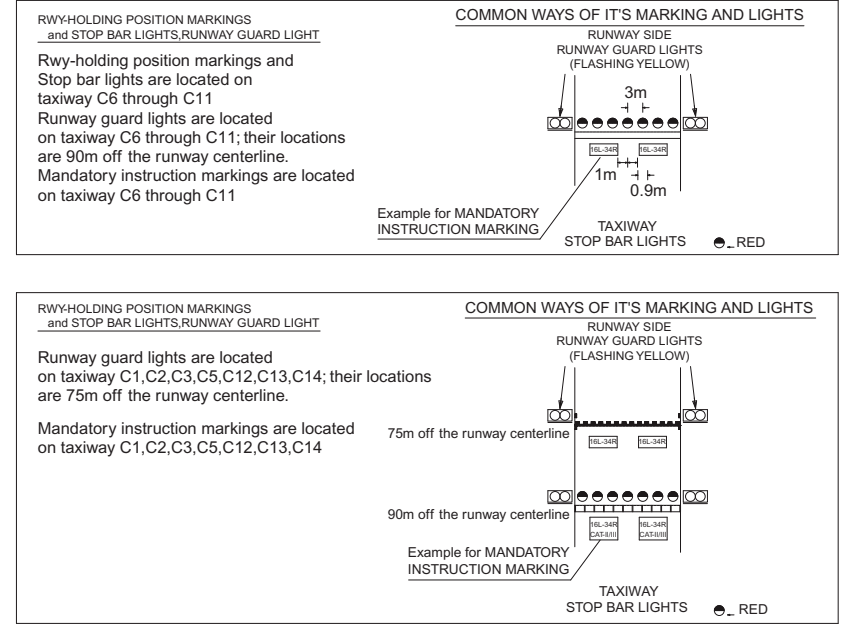
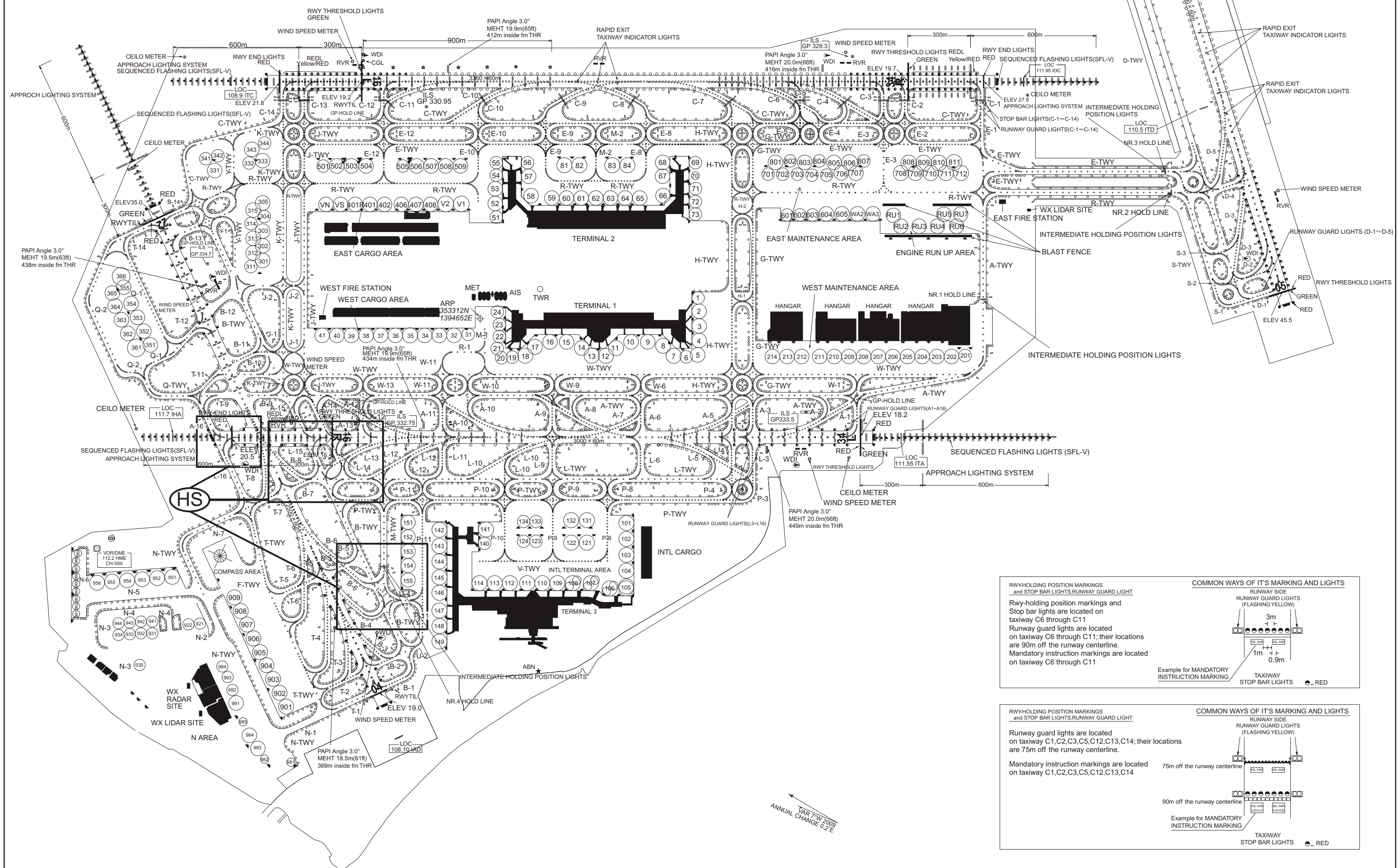

CHANGE: Editorial(RTHL FOR RWY 16R).



AERODROME OBSTACLE CHART-ICAO  
TYPE B

DIMENSIONS AND ELEVATIONS IN FEET BEARINGS ARE MAGNETIC

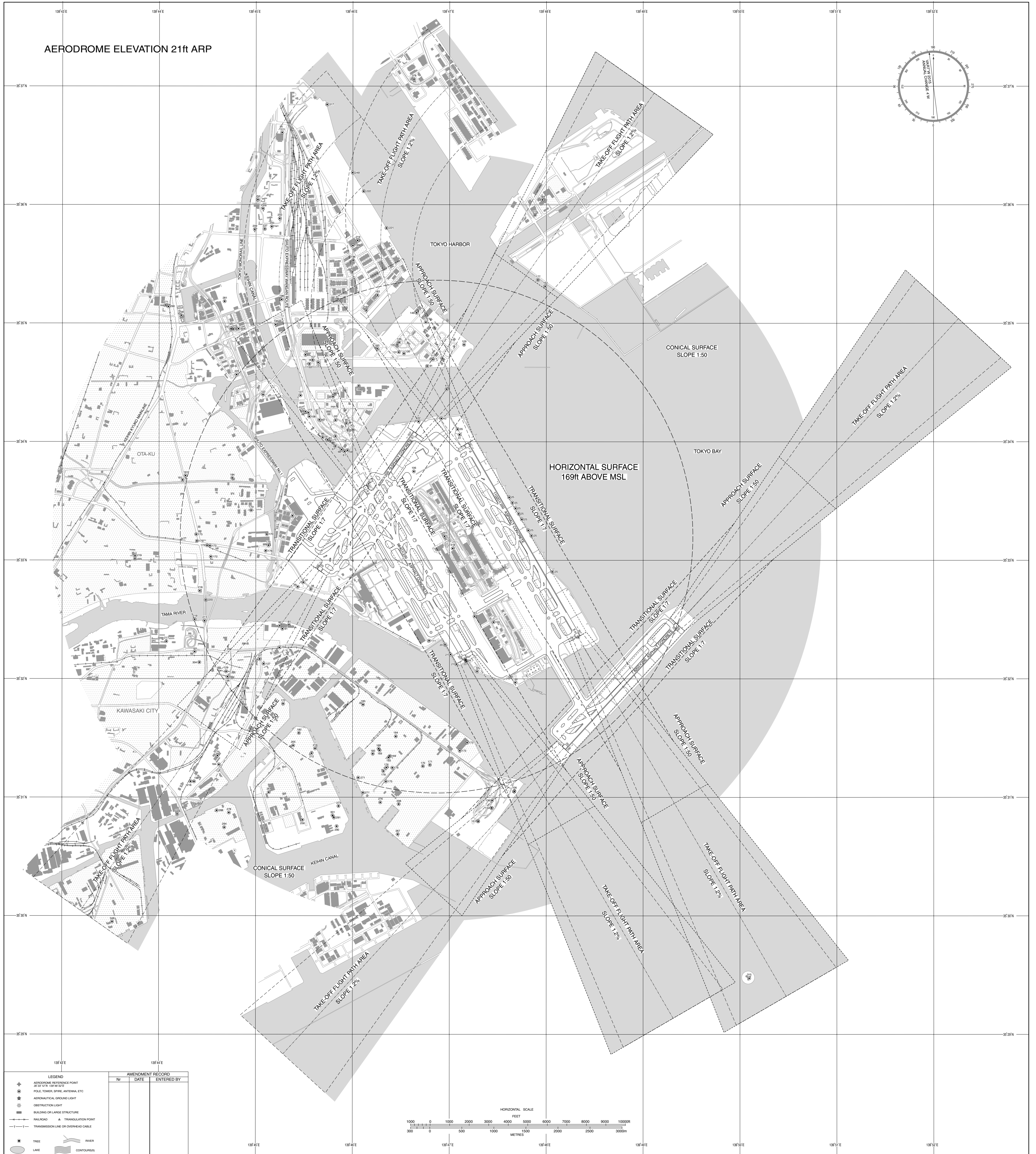

### PRECISION APPROACH TERRAIN CHART

DISTANCES AND HEIGHTS IN METRES

RWY34R

Displaced THR

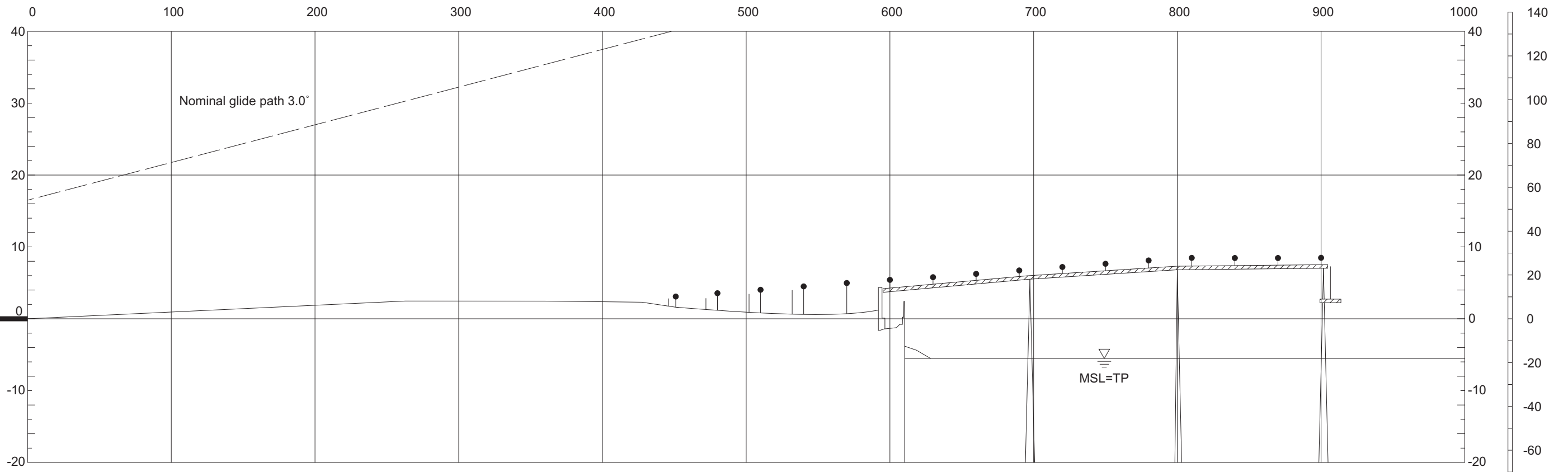
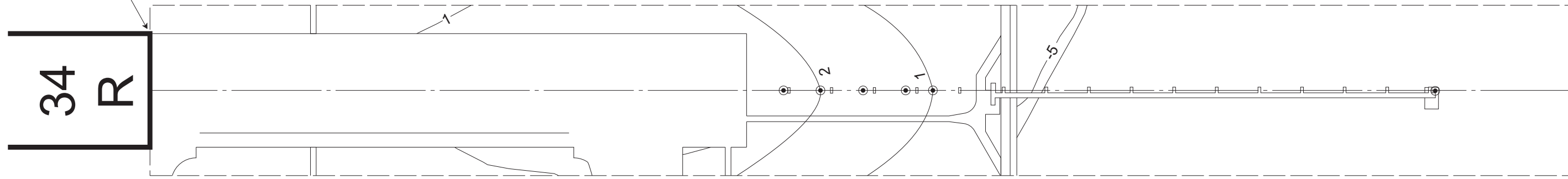

HORIZONTAL SCALE 1:2500

VERTICAL SCALE 1:500

CONTOUR AND HEIGHTS ARE RELATED  
TO ELEVATION OF DISPLACED THR OF RWY34R

LEGEND	
CONTOUR	-1
CENTER-LINE PROFILE	
DEVIATION AT LEAST ±3m FROM CENTER-LINE PROFILE	
APPROACH LIGHTING	
ANTENNA	

Vertical scale  
in feet

CHANGE: CONTOUR

STANDARD DEPARTURE CHART-INSTRUMENT

RJTT/TOKYO INTL RNAV SID

VAMOS THREE DEPARTURE		RNAV1
<p>Note 1) DME/DME/IRU or GNSS required.                      ※The aircraft equipped with only DME/DME/IRU must be able to update its position without delay at the starting point of take-off rolling.                      2) RADAR service required.</p>		
DME GAP	RWY16R:DER - 1.2NM FM DER RWY16L:DER - 1.0NM FM DER RWY34R:DER - 1.0NM FM DER RWY34L:DER - 0.5NM FM DER RWY04:DER - 1.7NM FM DER RWY22:DER - 1.4NM FM DER	Critical DME RWY16R:HME 1.2NM FM DER - 1.9NM to T6R11 RWY16L:HME 1.0NM FM DER - 2.4NM to T6L21 RWY34R:HME 1.0NM FM DER - 2.5NM to TT502 RWY34L:HME 0.5NM FM DER - 2.5NM to TT502 RWY04:HME 1.7NM FM DER - 2.5NM to TT502 RWY05:HME DER - 2.7NM to TT502
Inappropriate Nav aids	See AD1.1.6.10.3.Inappropriate NAVAIDs for RNAV1	

VAR8°W(2020)

CHANGE : PROC renamed. VAR. HDG after DEP FM RWY04,22. Course FM TT502 to LOCUP.

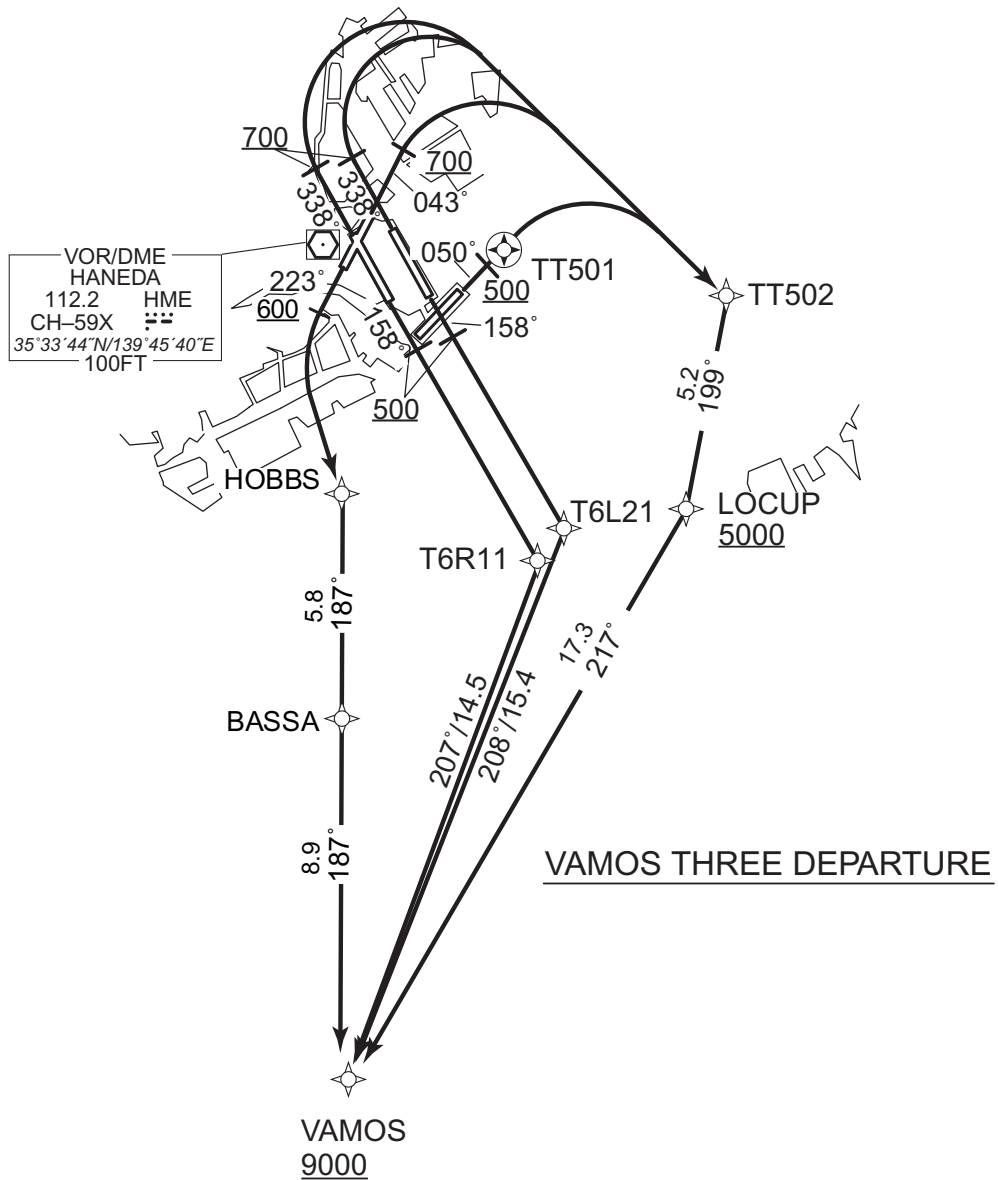

## STANDARD DEPARTURE CHART-INSTRUMENT

RJTT/TOKYO INTL

RNAV SID

VAMOS THREE DEPARTURE

RWY16R : Climb on HDG 158° at or above 500FT, direct to T6R11,  
to VAMOS at or above 9000FT.

RWY16L : Climb on HDG 158° at or above 500FT, direct to T6L21,  
to VAMOS at or above 9000FT.

RWY34L/34R : Climb on HDG 338° at or above 700FT, turn right direct to  
TT502, to LOCUP at or above 5000FT, to VAMOS at or above  
9000FT.

RWY04: Climb on HDG 043° at or above 700FT, turn right direct to TT502,  
to LOCUP at or above 5000FT, to VAMOS at or above 9000FT.

RWY05: Climb on HDG 050° at or above 500FT, direct to TT501, turn right  
direct to TT502, to LOCUP at or above 5000FT, to VAMOS at or  
above 9000FT.

RWY22: Climb on HDG 223° at or above 600FT, turn left direct to HOBBS,  
to BASSA, to VAMOS at or above 9000FT.

Note RWY34L/34R/04 : 5.0% climb gradient required up to 700FT.

RWY05 : 5.0% climb gradient required up to 500FT.

RWY22 : 5.0% climb gradient required up to 600FT.

CHANGE : PROC renamed. HDG after DEP FM RWY04,22.

STANDARD DEPARTURE CHART-INSTRUMENT

RJTT/TOKYO INTL

RNAV SID

VAMOS THREE DEPARTURE

RWY16R

Serial Number	Path Descriptor	Waypoint Identifier	Fly Over	Course °M(°T)	Magnetic Variation	Distance (NM)	Turn Direction	Altitude (FT)	Speed (KIAS)	Vertical Angle	Navigation Specification
001	VA	-	-	158 (150.0)	-7.6	-	-	+500	-	-	RNAV1
002	DF	T6R11	-	-	-7.6	-	-	-	-	-	RNAV1
003	TF	VAMOS	-	207 (199.5)	-7.6	14.5	-	+9000	-	-	RNAV1

RWY16L

Serial Number	Path Descriptor	Waypoint Identifier	Fly Over	Course °M(°T)	Magnetic Variation	Distance (NM)	Turn Direction	Altitude (FT)	Speed (KIAS)	Vertical Angle	Navigation Specification
001	VA	-	-	158 (150.0)	-7.6	-	-	+500	-	-	RNAV1
002	DF	T6L21	-	-	-7.6	-	-	-	-	-	RNAV1
003	TF	VAMOS	-	208 (200.7)	-7.6	15.4	-	+9000	-	-	RNAV1

RWY34L/RWY34R

Serial Number	Path Descriptor	Waypoint Identifier	Fly Over	Course °M(°T)	Magnetic Variation	Distance (NM)	Turn Direction	Altitude (FT)	Speed (KIAS)	Vertical Angle	Navigation Specification
001	VA	-	-	338 (330.0)	-7.6	-	-	+700	-	-	RNAV1
002	DF	TT502	-	-	-7.6	-	R	-	-	-	RNAV1
003	TF	LOCUP	-	199 (190.9)	-7.6	5.2	-	+5000	-	-	RNAV1
004	TF	VAMOS	-	217 (209.5)	-7.6	17.3	-	+9000	-	-	RNAV1

RWY04

Serial Number	Path Descriptor	Waypoint Identifier	Fly Over	Course °M(°T)	Magnetic Variation	Distance (NM)	Turn Direction	Altitude (FT)	Speed (KIAS)	Vertical Angle	Navigation Specification
001	VA	-	-	043 (034.9)	-7.6	-	-	+700	-	-	RNAV1
002	DF	TT502	-	-	-7.6	-	R	-	-	-	RNAV1
003	TF	LOCUP	-	199 (190.9)	-7.6	5.2	-	+5000	-	-	RNAV1
004	TF	VAMOS	-	217 (209.5)	-7.6	17.3	-	+9000	-	-	RNAV1

CHANGE : PROC renamed. Magnetic Variation. RWY34L/RWY34R:NR003(Course). RWY04:NR001,003(Course).



STANDARD DEPARTURE CHART-INSTRUMENT

RJTT/TOKYO INTL

RNAV SID

RWY05

Serial Number	Path Descriptor	Waypoint Identifier	Fly Over	Course °M(°T)	Magnetic Variation	Distance (NM)	Turn Direction	Altitude (FT)	Speed (KIAS)	Vertical Angle	Navigation Specification
001	VA	-	-	050 (042.4)	-7.6	-	-	+500	-	-	RNAV1
002	DF	TT501	Y	-	-7.6	-	-	-	-	-	RNAV1
003	DF	TT502	-	-	-7.6	-	R	-	-	-	RNAV1
004	TF	LOCUP	-	199 (190.9)	-7.6	5.2	-	+5000	-	-	RNAV1
005	TF	VAMOS	-	217 (209.5)	-7.6	17.3	-	+9000	-	-	RNAV1

RWY22

Serial Number	Path Descriptor	Waypoint Identifier	Fly Over	Course °M(°T)	Magnetic Variation	Distance (NM)	Turn Direction	Altitude (FT)	Speed (KIAS)	Vertical Angle	Navigation Specification
001	VA	-	-	223 (214.9)	-7.6	-	-	+600	-	-	RNAV1
002	DF	HOBBS	-	-	-7.6	-	L	-	-	-	RNAV1
003	TF	BASSA	-	187 (179.9)	-7.6	5.8	-	-	-	-	RNAV1
004	TF	VAMOS	-	187 (179.9)	-7.6	8.9	-	+9000	-	-	RNAV1

Waypoint Coordinates

Waypoint Identifier	Coordinates	Waypoint Identifier	Coordinates
BASSA	352108.8N / 1394542.2E	T6R11	352552.5N / 1395137.2E
HOBBS	352653.9N / 1394541.3E	TT501	353328.7N / 1395029.9E
LOCUP	352718.8N / 1395608.5E	TT502	353224.4N / 1395720.7E
T6L21	352639.1N / 1395222.0E	VAMOS	351215.5N / 1394543.6E

CHANGE : Magnetic Variation. RWY05:NR004(Course). RWY22:NR001(Course).

STANDARD DEPARTURE CHART-INSTRUMENT

RJTT/TOKYO INTL		RNAV TRANSITION	
TATEYAMA TRANSITION / DRAKY TRANSITION		RNAV1	
Note 1) DME/DME/IRU or GNSS required. 2) RADAR service required.			
DME GAP	-	Critical DME	-
Inappropriate NavAids	See AD1.1.6.10.3.Inappropriate NAVAIDS for RNAV1		

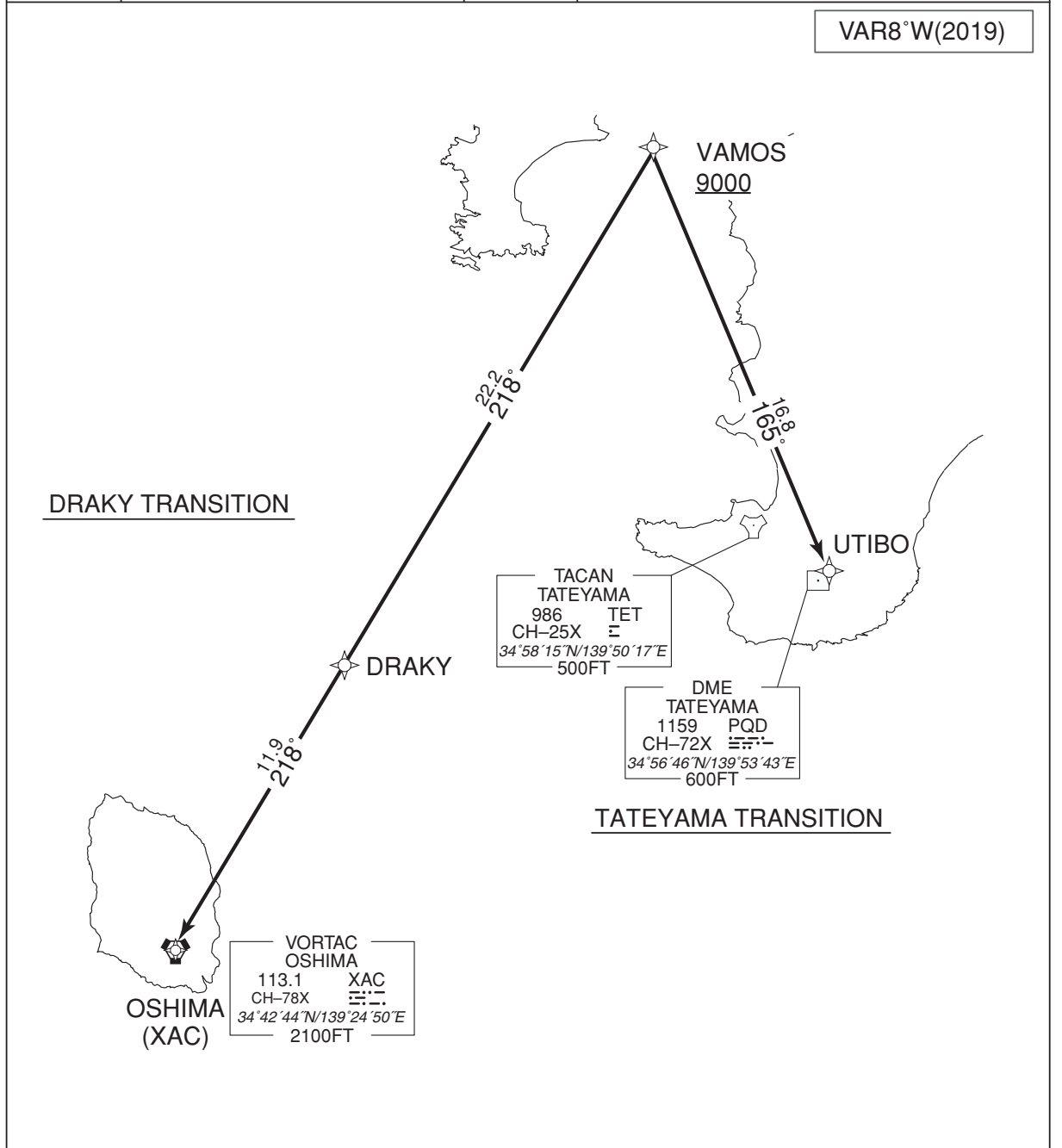

STANDARD DEPARTURE CHART-INSTRUMENT

RJTT/TOKYO INTL

RNAV TRANSITION

TATEYAMA TRANSITION

From VAMOS at or above 9000FT, to UTIBO.

Serial Number	Path Descriptor	Waypoint Identifier	Fly Over	Course °M(°T)	Magnetic Variation	Distance (NM)	Turn Direction	Altitude (FT)	Speed (KIAS)	Vertical Angle	Navigation Specification
001	IF	VAMOS	—	—	-7.5	—	—	+9000	—	—	RNAV1
002	TF	UTIBO	—	165 (157.0)	-7.5	16.8	—	—	—	—	RNAV1

DRAKY TRANSITION

From VAMOS at or above 9000FT, to DRAKY, to XAC.

Serial Number	Path Descriptor	Waypoint Identifier	Fly Over	Course °M(°T)	Magnetic Variation	Distance (NM)	Turn Direction	Altitude (FT)	Speed (KIAS)	Vertical Angle	Navigation Specification
001	IF	VAMOS	—	—	-7.5	—	—	+9000	—	—	RNAV1
002	TF	DRAKY	—	218 (210.2)	-7.5	22.2	—	—	—	—	RNAV1
003	TF	XAC	—	218 (210.1)	-7.5	11.9	—	—	—	—	RNAV1

Waypoint Coordinates

Waypoint Identifier	Coordinates	Waypoint Identifier	Coordinates
DRAKY	345301.7N / 1393205.5E	VAMOS	351215.5N / 1394543.6E
UTIBO	345647.0N / 1395343.9E	XAC	344244.1N / 1392450.5E

CHANGE : New PROC

STANDARD DEPARTURE CHART-INSTRUMENT

RJTT/TOKYO INTL RNAV SID

LAXAS THREE DEPARTURE		RNAV1
Note 1) DME/DME/IRU or GNSS required. ※The aircraft equipped with only DME/DME/IRU must be able to update its position without delay at the starting point of take-off rolling. 2) RADAR service required.		RWY16R: HME 1.2NM FM DER - 1.9NM to T6R11 HYD T6R11 - TAURA RWY16L: HME 1.0NM FM DER - 2.4NM to T6L21 HYD 9.0NM to TAURA - TAURA RWY34R: HME 1.0NM FM DER - 2.5NM to TT502 HYD 8.6NM to TAURA - TAURA RWY34L: HME 0.5NM FM DER - 2.5NM to TT502 HYD 8.6NM to TAURA - TAURA RWY04: HME 1.7NM FM DER - 2.5NM to TT502 HYD 8.6NM to TAURA - TAURA RWY05: HME DER - 2.7NM to TT502 HYD 8.6NM to TAURA - TAURA
DME GAP	RWY16R:DER - 1.2NM FM DER RWY16L:DER - 1.0NM FM DER RWY34R:DER - 1.0NM FM DER RWY34L:DER - 0.5NM FM DER RWY04:DER - 1.7NM FM DER RWY22:DER - 1.4NM FM DER	
Inappropriate Nav aids	See AD1.1.6.10.3.Inappropriate NAVAIDs for RNAV1	

CHANGE : PROC renamed. VAR. HDG after DEP FM RWY04,22. Course FM TT502 to LOCUP. Course FM BASSA to UMUKI.

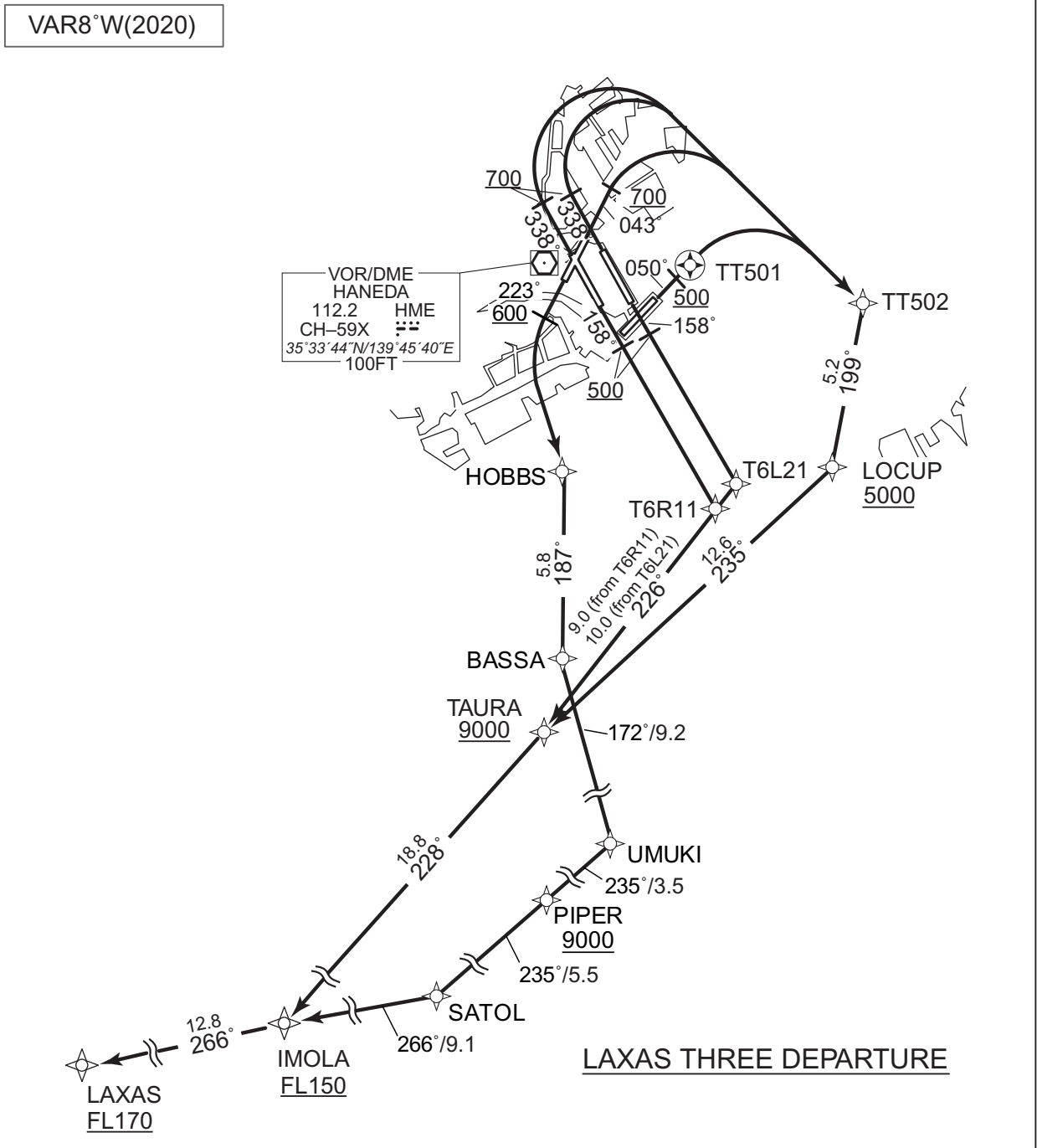

## STANDARD DEPARTURE CHART-INSTRUMENT

RJTT/TOKYO INTL

RNAV SID

LAXAS THREE DEPARTURE

RWY16R : Climb on HDG 158° at or above 500FT, direct to T6R11,  
to TAURA at or above 9000FT, to IMOLA at or above FL150,  
to LAXAS at or above FL170.

RWY16L : Climb on HDG 158° at or above 500FT, direct to T6L21,  
to TAURA at or above 9000FT, to IMOLA at or above FL150,  
to LAXAS at or above FL170.

RWY34L/34R : Climb on HDG 338° at or above 700FT, turn right direct to  
TT502, to LOCUP at or above 5000FT, to TAURA at or above  
9000FT, to IMOLA at or above FL150, to LAXAS at or above  
FL170.

RWY04 : Climb on HDG 043° at or above 700FT, turn right direct to TT502,  
to LOCUP at or above 5000FT, to TAURA at or above 9000FT,  
to IMOLA at or above FL150, to LAXAS at or above FL170.

RWY05 : Climb on HDG 050° at or above 500FT, direct to TT501, turn right  
direct to TT502, to LOCUP at or above 5000FT, to TAURA at or  
above 9000FT, to IMOLA at or above FL150, to LAXAS at or above  
FL170.

RWY22 : Climb on HDG 223° at or above 600FT, turn left direct to HOBBS,  
to BASSA, to UMUKI, to PIPER at or above 9000FT, to SATOL,  
to IMOLA at or above FL150, to LAXAS at or above FL170.

Note RWY34L/34R/04 : 5.0% climb gradient required up to 700FT.  
RWY05 : 5.0% climb gradient required up to 500FT.  
RWY22 : 5.0% climb gradient required up to 600FT.

CHANGE : PROC renamed. HDG after DEP FM RWY04,22.

STANDARD DEPARTURE CHART-INSTRUMENT

RJTT/TOKYO INTL

RNAV SID

LAXAS THREE DEPARTURE

RWY16R

Serial Number	Path Descriptor	Waypoint Identifier	Fly Over	Course °M(°T)	Magnetic Variation	Distance (NM)	Turn Direction	Altitude (FT)	Speed (KIAS)	Vertical Angle	Navigation Specification
001	VA	-	-	158 (150.0)	-7.6	-	-	+500	-	-	RNAV1
002	DF	T6R11	-	-	-7.6	-	-	-	-	-	RNAV1
003	TF	TAURA	-	226 (218.1)	-7.6	9.0	-	+9000	-	-	RNAV1
004	TF	IMOLA	-	228 (220.5)	-7.6	18.8	-	+FL150	-	-	RNAV1
005	TF	LAXAS	-	266 (258.6)	-7.6	12.8	-	+FL170	-	-	RNAV1

RWY16L

Serial Number	Path Descriptor	Waypoint Identifier	Fly Over	Course °M(°T)	Magnetic Variation	Distance (NM)	Turn Direction	Altitude (FT)	Speed (KIAS)	Vertical Angle	Navigation Specification
001	VA	-	-	158 (150.0)	-7.6	-	-	+500	-	-	RNAV1
002	DF	T6L21	-	-	-7.6	-	-	-	-	-	RNAV1
003	TF	TAURA	-	226 (218.1)	-7.6	10.0	-	+9000	-	-	RNAV1
004	TF	IMOLA	-	228 (220.5)	-7.6	18.8	-	+FL150	-	-	RNAV1
005	TF	LAXAS	-	266 (258.6)	-7.6	12.8	-	+FL170	-	-	RNAV1

RWY34L/RWY34R

Serial Number	Path Descriptor	Waypoint Identifier	Fly Over	Course °M(°T)	Magnetic Variation	Distance (NM)	Turn Direction	Altitude (FT)	Speed (KIAS)	Vertical Angle	Navigation Specification
001	VA	-	-	338 (330.0)	-7.6	-	-	+700	-	-	RNAV1
002	DF	TT502	-	-	-7.6	-	R	-	-	-	RNAV1
003	TF	LOCUP	-	199 (190.9)	-7.6	5.2	-	+5000	-	-	RNAV1
004	TF	TAURA	-	235 (227.3)	-7.6	12.6	-	+9000	-	-	RNAV1
005	TF	IMOLA	-	228 (220.5)	-7.6	18.8	-	+FL150	-	-	RNAV1
006	TF	LAXAS	-	266 (258.6)	-7.6	12.8	-	+FL170	-	-	RNAV1

CHANGE : PROC renamed. Magnetic Variation. RWY34L/RWY34R:NR003(Course).

STANDARD DEPARTURE CHART-INSTRUMENT

RJTT/TOKYO INTL

RNAV SID

RWY04

Serial Number	Path Descriptor	Waypoint Identifier	Fly Over	Course °M(°T)	Magnetic Variation	Distance (NM)	Turn Direction	Altitude (FT)	Speed (KIAS)	Vertical Angle	Navigation Specification
001	VA	-	-	043 (034.9)	-7.6	-	-	+700	-	-	RNAV1
002	DF	TT502	-	-	-7.6	-	R	-	-	-	RNAV1
003	TF	LOCUP	-	199 (190.9)	-7.6	5.2	-	+5000	-	-	RNAV1
004	TF	TAURA	-	235 (227.3)	-7.6	12.6	-	+9000	-	-	RNAV1
005	TF	IMOLA	-	228 (220.5)	-7.6	18.8	-	+FL150	-	-	RNAV1
006	TF	LAXAS	-	266 (258.6)	-7.6	12.8	-	+FL170	-	-	RNAV1

RWY05

Serial Number	Path Descriptor	Waypoint Identifier	Fly Over	Course °M(°T)	Magnetic Variation	Distance (NM)	Turn Direction	Altitude (FT)	Speed (KIAS)	Vertical Angle	Navigation Specification
001	VA	-	-	050 (042.4)	-7.6	-	-	+500	-	-	RNAV1
002	DF	TT501	Y	-	-7.6	-	-	-	-	-	RNAV1
003	DF	TT502	-	-	-7.6	-	R	-	-	-	RNAV1
004	TF	LOCUP	-	199 (190.9)	-7.6	5.2	-	+5000	-	-	RNAV1
005	TF	TAURA	-	235 (227.3)	-7.6	12.6	-	+9000	-	-	RNAV1
006	TF	IMOLA	-	228 (220.5)	-7.6	18.8	-	+FL150	-	-	RNAV1
007	TF	LAXAS	-	266 (258.6)	-7.6	12.8	-	+FL170	-	-	RNAV1

CHANGE : Magnetic Variation. RWY04:NR001,003(Course). RWY05:NR004(Course).

STANDARD DEPARTURE CHART-INSTRUMENT

RJTT/TOKYO INTL

RNAV SID

RWY22

Serial Number	Path Descriptor	Waypoint Identifier	Fly Over	Course °M(°T)	Magnetic Variation	Distance (NM)	Turn Direction	Altitude (FT)	Speed (KIAS)	Vertical Angle	Navigation Specification
001	VA	-	-	223 (214.9)	-7.6	-	-	+600	-	-	RNAV1
002	DF	HOBBS	-	-	-7.6	-	L	-	-	-	RNAV1
003	TF	BASSA	-	187 (179.9)	-7.6	5.8	-	-	-	-	RNAV1
004	TF	UMUKI	-	172 (163.9)	-7.6	9.2	-	-	-	-	RNAV1
005	TF	PIPER	-	235 (227.4)	-7.6	3.5	-	+9000	-	-	RNAV1
006	TF	SATOL	-	235 (227.4)	-7.6	5.5	-	-	-	-	RNAV1
007	TF	IMOLA	-	266 (258.7)	-7.6	9.1	-	+FL150	-	-	RNAV1
008	TF	LAXAS	-	266 (258.6)	-7.6	12.8	-	+FL170	-	-	RNAV1

Waypoint Coordinates

Waypoint Identifier	Coordinates	Waypoint Identifier	Coordinates
BASSA	352108.8N / 1394542.2E	T6L21	352639.1N / 1395222.0E
HOBBS	352653.9N / 1394541.3E	T6R11	352552.5N / 1395137.2E
IMOLA	350426.0N / 1392951.0E	TAURA	351846.1N / 1394447.3E
LAXAS	350153.1N / 1391432.8E	TT501	353328.7N / 1395029.9E
LOCUP	352718.8N / 1395608.5E	TT502	353224.4N / 1395720.7E
PIPER	350958.3N / 1394542.0E	UMUKI	351219.1N / 1394849.2E
SATOL	350613.3N / 1394043.4E		

CHANGE : Magnetic Variation. RWY22:NR001,004(Course).



STANDARD DEPARTURE CHART-INSTRUMENT

RJTT/TOKYO INTL

RNAV SID

NINOX THREE DEPARTURE

RNAV1

Note 1) DME/DME/IRU or GNSS required.  
 ※The aircraft equipped with only DME/DME/IRU must be able to update its position without delay at the starting point of take-off rolling.  
 2) RADAR service required.

DME GAP	RWY16R : DER - 1.2NM FM DER RWY16L : DER - 1.0NM FM DER RWY34R : DER - 1.0NM FM DER RWY34L : DER - 0.5NM FM DER RWY04 : DER - 1.7NM FM DER RWY22 : DER - 1.4NM FM DER	Critical DME
Inappropriate Nav aids	See AD1.1.6.10.3.Inappropriate NAVAIDs for RNAV1	

RWY16R : HME 1.2NM FM DER - 3.8NM to T6R12 HYD T6R12 - TT631 PQD 1.0NM to BAYGE - 6.5NM to SEIKO
RWY16L : HME 1.0NM FM DER - 4.7NM to T6L22 HYD 5.6NM to TT631 - TT631 PQD 1.0NM to BAYGE - 6.5NM to SEIKO
RWY34R : HME 1.0NM FM DER - 2.5NM to TT502 HYD 6.5NM to BAYGE - BAYGE PQD BAYGE - 6.5NM to SEIKO
RWY34L : HME 0.5NM FM DER - 2.5NM to TT502 HYD 6.5NM to BAYGE - BAYGE PQD BAYGE - 6.5NM to SEIKO
RWY04 : HME 1.7NM FM DER - 2.5NM to TT502 HYD 6.5NM to BAYGE - BAYGE PQD BAYGE - 6.5NM to SEIKO
RWY05 : HME DER - 2.7NM to TT502 HYD 6.5NM to BAYGE - BAYGE PQD BAYGE - 6.5NM to SEIKO

CHANGE : PROC renamed. VAR. HDG after DEP FM RWY04,22. Course FM TT502 to LOCUP. Course FM TT631 to BAYGE. Course FM BASSA to UMUKI. Course FM SEIKO to NINOX.

VAR8°W(2020)

NINOX THREE DEPARTURE

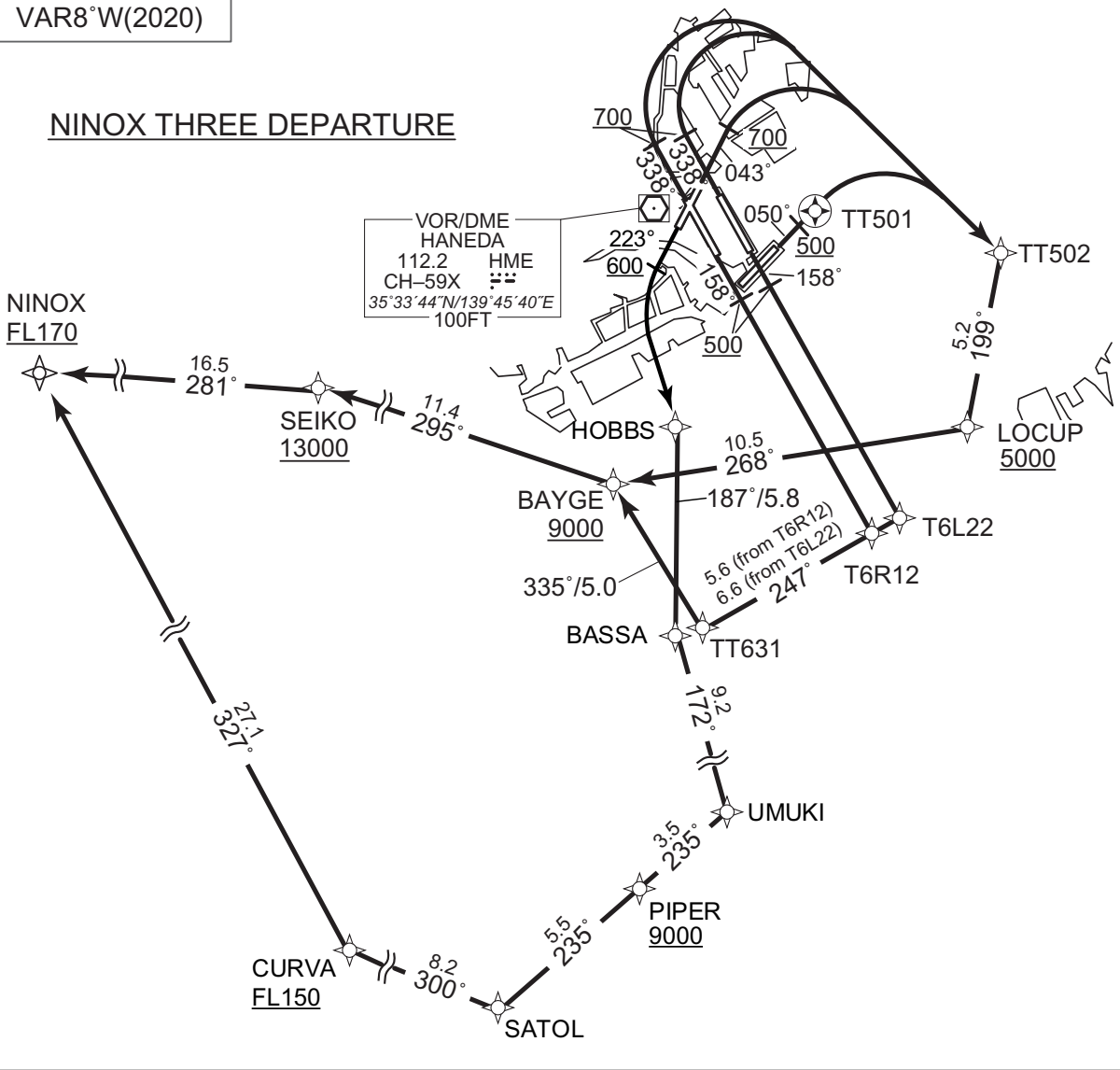

STANDARD DEPARTURE CHART-INSTRUMENT

RJTT/TOKYO INTL

RNAV SID

NINOX THREE DEPARTURE

RWY16R : Climb on HDG 158° at or above 500FT, direct to T6R12, to TT631, to BAYGE at or above 9000FT, to SEIKO at or above 13000FT, to NINOX at or above FL170.

RWY16L : Climb on HDG 158° at or above 500FT, direct to T6L22, to TT631, to BAYGE at or above 9000FT, to SEIKO at or above 13000FT, to NINOX at or above FL170.

RWY34L/34R : Climb on HDG 338° at or above 700FT, turn right direct to TT502, to LOCUP at or above 5000FT, to BAYGE at or above 9000FT, to SEIKO at or above 13000FT, to NINOX at or above FL170.

RWY04 : Climb on HDG 043° at or above 700FT, turn right direct to TT502, to LOCUP at or above 5000FT, to BAYGE at or above 9000FT, to SEIKO at or above 13000FT, to NINOX at or above FL170.

RWY05 : Climb on HDG 050° at or above 500FT, direct to TT501, turn right direct to TT502, to LOCUP at or above 5000FT, to BAYGE at or above 9000FT, to SEIKO at or above 13000FT, to NINOX at or above FL170.

RWY22 : Climb on HDG 223° at or above 600FT, turn left direct to HOBBS, to BASSA, to UMUKI, to PIPER at or above 9000FT, to SATOL, to CURVA at or above FL150, to NINOX at or above FL170.

Note RWY34L/34R/04 : 5.0% climb gradient required up to 700FT.  
RWY05 : 5.0% climb gradient required up to 500FT.  
RWY22 : 5.0% climb gradient required up to 600FT.

CHANGE : PROC renamed. HDG after DEP FM RWY04,22.

STANDARD DEPARTURE CHART-INSTRUMENT

RJTT/TOKYO INTL

RNAV SID

NINOX THREE DEPARTURE

RWY16R

Serial Number	Path Descriptor	Waypoint Identifier	Fly Over	Course °M(°T)	Magnetic Variation	Distance (NM)	Turn Direction	Altitude (FT)	Speed (KIAS)	Vertical Angle	Navigation Specification
001	VA	-	-	158 (150.0)	-7.6	-	-	+500	-	-	RNAV1
002	DF	T6R12	-	-	-7.6	-	-	-	-	-	RNAV1
003	TF	TT631	-	247 (239.8)	-7.6	5.6	-	-	-	-	RNAV1
004	TF	BAYGE	-	335 (327.0)	-7.6	5.0	-	+9000	-	-	RNAV1
005	TF	SEIKO	-	295 (287.8)	-7.6	11.4	-	+13000	-	-	RNAV1
006	TF	NINOX	-	281 (272.9)	-7.6	16.5	-	+FL170	-	-	RNAV1

RWY16L

Serial Number	Path Descriptor	Waypoint Identifier	Fly Over	Course °M(°T)	Magnetic Variation	Distance (NM)	Turn Direction	Altitude (FT)	Speed (KIAS)	Vertical Angle	Navigation Specification
001	VA	-	-	158 (150.0)	-7.6	-	-	+500	-	-	RNAV1
002	DF	T6L22	-	-	-7.6	-	-	-	-	-	RNAV1
003	TF	TT631	-	247 (239.8)	-7.6	6.6	-	-	-	-	RNAV1
004	TF	BAYGE	-	335 (327.0)	-7.6	5.0	-	+9000	-	-	RNAV1
005	TF	SEIKO	-	295 (287.8)	-7.6	11.4	-	+13000	-	-	RNAV1
006	TF	NINOX	-	281 (272.9)	-7.6	16.5	-	+FL170	-	-	RNAV1

RWY34L/RWY34R

Serial Number	Path Descriptor	Waypoint Identifier	Fly Over	Course °M(°T)	Magnetic Variation	Distance (NM)	Turn Direction	Altitude (FT)	Speed (KIAS)	Vertical Angle	Navigation Specification
001	VA	-	-	338 (330.0)	-7.6	-	-	+700	-	-	RNAV1
002	DF	TT502	-	-	-7.6	-	R	-	-	-	RNAV1
003	TF	LOCUP	-	199 (190.9)	-7.6	5.2	-	+5000	-	-	RNAV1
004	TF	BAYGE	-	268 (260.6)	-7.6	10.5	-	+9000	-	-	RNAV1
005	TF	SEIKO	-	295 (287.8)	-7.6	11.4	-	+13000	-	-	RNAV1
006	TF	NINOX	-	281 (272.9)	-7.6	16.5	-	+FL170	-	-	RNAV1

CHANGE : PROC renamed. Magnetic Variation. RWY16R:NR004,006(Course). RWY16L:NR004,006(Course). RWY34L/RWY34R:NR003,006(Course).

STANDARD DEPARTURE CHART-INSTRUMENT

RJTT/TOKYO INTL

RNAV SID

RWY04

Serial Number	Path Descriptor	Waypoint Identifier	Fly Over	Course °M(°T)	Magnetic Variation	Distance (NM)	Turn Direction	Altitude (FT)	Speed (KIAS)	Vertical Angle	Navigation Specification
001	VA	-	-	043 (034.9)	-7.6	-	-	+700	-	-	RNAV1
002	DF	TT502	-	-	-7.6	-	R	-	-	-	RNAV1
003	TF	LOCUP	-	199 (190.9)	-7.6	5.2	-	+5000	-	-	RNAV1
004	TF	BAYGE	-	268 (260.6)	-7.6	10.5	-	+9000	-	-	RNAV1
005	TF	SEIKO	-	295 (287.8)	-7.6	11.4	-	+13000	-	-	RNAV1
006	TF	NINOX	-	281 (272.9)	-7.6	16.5	-	+FL170	-	-	RNAV1

RWY05

Serial Number	Path Descriptor	Waypoint Identifier	Fly Over	Course °M(°T)	Magnetic Variation	Distance (NM)	Turn Direction	Altitude (FT)	Speed (KIAS)	Vertical Angle	Navigation Specification
001	VA	-	-	050 (042.4)	-7.6	-	-	+500	-	-	RNAV1
002	DF	TT501	Y	-	-7.6	-	-	-	-	-	RNAV1
003	DF	TT502	-	-	-7.6	-	R	-	-	-	RNAV1
004	TF	LOCUP	-	199 (190.9)	-7.6	5.2	-	+5000	-	-	RNAV1
005	TF	BAYGE	-	268 (260.6)	-7.6	10.5	-	+9000	-	-	RNAV1
006	TF	SEIKO	-	295 (287.8)	-7.6	11.4	-	+13000	-	-	RNAV1
007	TF	NINOX	-	281 (272.9)	-7.6	16.5	-	+FL170	-	-	RNAV1

CHANGE : Magnetic Variation. RWY04:NR001,003,006(Course). RWY05:NR004,007(Course).

STANDARD DEPARTURE CHART-INSTRUMENT

RJTT/TOKYO INTL

RNAV SID

RWY22

Serial Number	Path Descriptor	Waypoint Identifier	Fly Over	Course °M(°T)	Magnetic Variation	Distance (NM)	Turn Direction	Altitude (FT)	Speed (KIAS)	Vertical Angle	Navigation Specification
001	VA	-	-	223 (214.9)	-7.6	-	-	+600	-	-	RNAV1
002	DF	HOBBS	-	-	-7.6	-	L	-	-	-	RNAV1
003	TF	BASSA	-	187 (179.9)	-7.6	5.8	-	-	-	-	RNAV1
004	TF	UMUKI	-	172 (163.9)	-7.6	9.2	-	-	-	-	RNAV1
005	TF	PIPER	-	235 (227.4)	-7.6	3.5	-	+9000	-	-	RNAV1
006	TF	SATOL	-	235 (227.4)	-7.6	5.5	-	-	-	-	RNAV1
007	TF	CURVA	-	300 (292.2)	-7.6	8.2	-	+FL150	-	-	RNAV1
008	TF	NINOX	-	327 (319.6)	-7.6	27.1	-	+FL170	-	-	RNAV1

Waypoint Coordinates

Waypoint Identifier	Coordinates	Waypoint Identifier	Coordinates
BASSA	352108.8N / 1394542.2E	SEIKO	352904.5N / 1393005.0E
BAYGE	352535.4N / 1394327.4E	T6L22	352441.2N / 1395345.4E
CURVA	350919.0N / 1393124.4E	T6R12	352413.6N / 1395247.1E
HOBBS	352653.9N / 1394541.3E	TT501	353328.7N / 1395029.9E
LOCUP	352718.8N / 1395608.5E	TT502	353224.4N / 1395720.7E
NINOX	352953.4N / 1390953.1E	TT631	352123.4N / 1394648.6E
PIPER	350958.3N / 1394542.0E	UMUKI	351219.1N / 1394849.2E
SATOL	350613.3N / 1394043.4E		

CHANGE : Magnetic Variation. RWY22:NR001,004(Course).

STANDARD DEPARTURE CHART-INSTRUMENT

RJTT/TOKYO INTL		RNAV SID	
RITLA TWO A DEPARTURE		RNAV1	
<p>Note 1) DME/DME/IRU or GNSS required.                      ※The aircraft equipped with only DME/DME/IRU must be able to update its position without delay at the starting point of take-off rolling.                      2) RADAR service required.</p>		<p>RWY16R : HME 1.2NM FM DER - HATBA                      HYD 2.8NM to HATBA - 1.6NM to HATBA                      KAMAT - 9.2NM to LAYER                      PQD HATBA - 1.6NM to KAMAT                      KAMAT - 9.2NM to LAYER                      SND 11.2NM to LAYER - LAYER</p> <p>RWY16L : HME 1.0NM FM DER - 3.5NM to T6L23                      PQD 6.6NM to KAIJI - KAIJI                      NRE 6.9NM to INTEL - 6.9NM to LAYER</p> <p>RWY34R : HME 1.0NM FM DER - 1.1NM to PLUTO                      SND TORAM - 3.1NM to PLUTO                      PQD 6.6NM to KAIJI - KAIJI                      NRE 6.9NM to INTEL - 6.9NM to LAYER</p> <p>RWY34L : HME 0.5NM FM DER - 1.1NM to PLUTO                      SND TORAM - 3.1NM to PLUTO                      PQD 6.6NM to KAIJI - KAIJI                      NRE 6.9NM to INTEL - 6.9NM to LAYER</p> <p>RWY04 : HME 1.7NM FM DER - 1.1NM to PLUTO                      SND 2.2NM to TORAM - 3.1NM to PLUTO                      PQD 6.6NM to KAIJI - KAIJI                      NRE 6.9NM to INTEL - 6.9NM to LAYER</p> <p>RWY05 : HME DER - 2.7NM to TT502                      TT503 - 3.8NM to KAMAT                      1.8NM to KAMAT - KAMAT                      HYD 1.2NM to TT503 - TT503                      4.8NM to KAMAT - 3.8NM to KAMAT                      PQD KAMAT - 9.2NM to LAYER                      SND 11.2NM to LAYER - LAYER</p>	
DME GAP	<p>RWY16R : DER - 1.2NM FM DER                      RWY16L : DER - 1.0NM FM DER                      RWY34R : DER - 1.0NM FM DER                      RWY34L : DER - 0.5NM FM DER                      RWY04 : DER - 1.7NM FM DER                      RWY05 : 3.8NM to KAMAT - 1.8NM to KAMAT</p>	Critical DME	
Inappropriate Nav aids	See AD1.1.6.10.3.Inappropriate NAVAIDs for RNAV1		

VAR8°W(2020)

RITLA TWO A DEPARTURE RWY16R/16L

CHANGE : PROC renamed. VAR. RTE after LAYER. TIARA established.

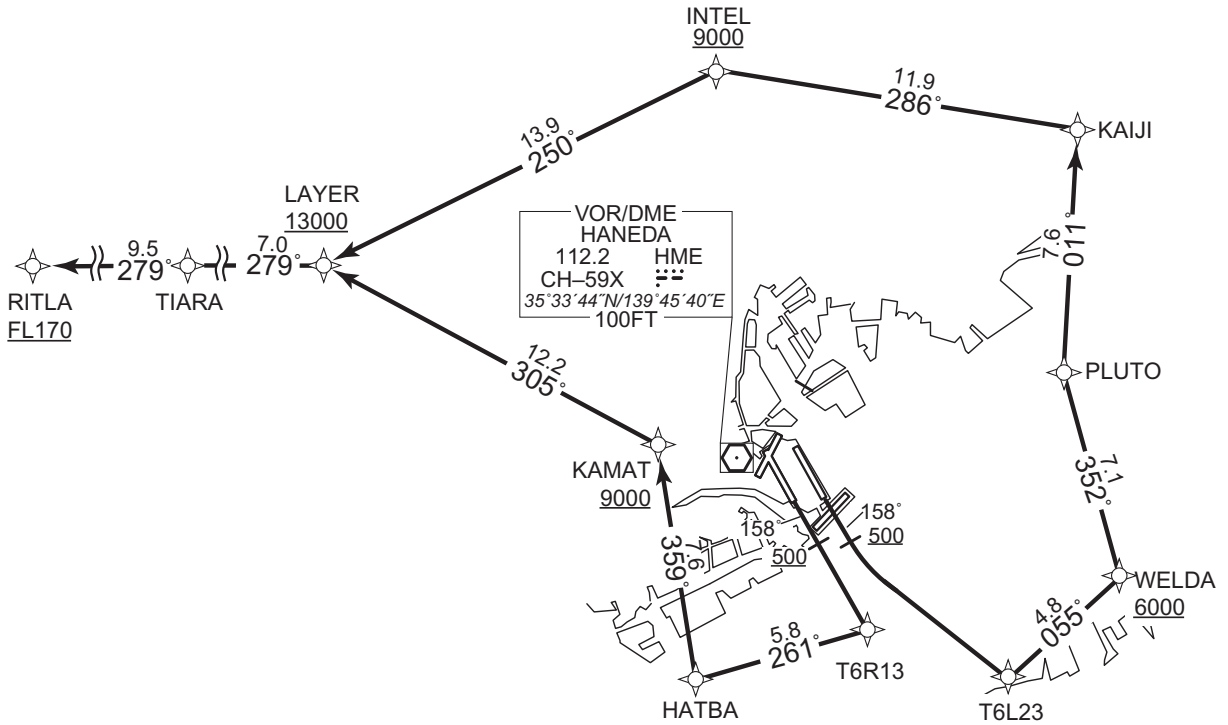

STANDARD DEPARTURE CHART-INSTRUMENT

RJTT/TOKYO INTL

RNAV SID

VAR8°W(2020)

RITLA TWO A DEPARTURE RWY 34L/34R/04/05

CHANGE : PROC renamed. VAR. RTE after LAYER. TIARA established. HDG after DEP FM RWY04. Course FM TT502 to LOCUP.

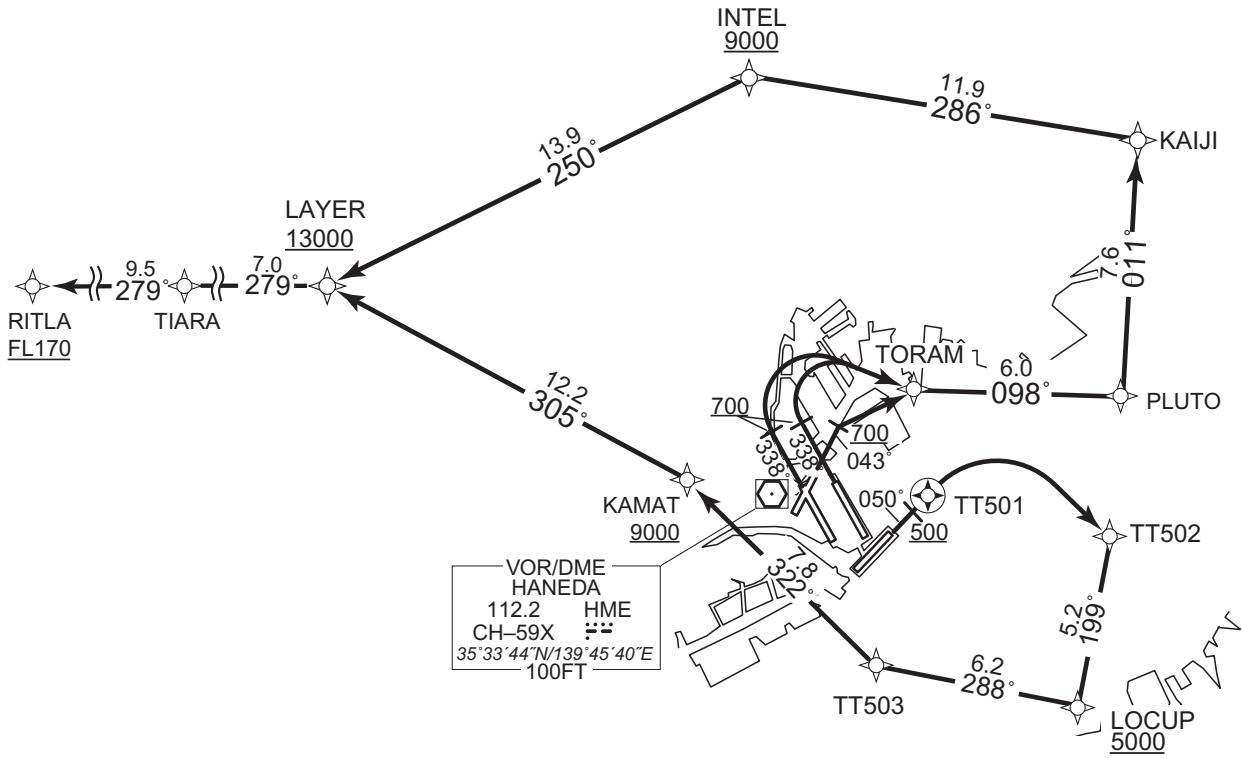

STANDARD DEPARTURE CHART-INSTRUMENT

RJTT/TOKYO INTL

RNAV SID

RITLA TWO A DEPARTURE

RWY16R : Climb on HDG 158° at or above 500FT, direct to T6R13,  
to HATBA, to KAMAT at or above 9000FT, to LAYER at or above  
13000FT, to TIARA, to RITLA at or above FL170.

RWY16L : Climb on HDG 158° at or above 500FT, turn left direct to T6L23,  
to WELDA at or above 6000FT, to PLUTO, to KAIJI, to INTEL at or  
above 9000FT, to LAYER at or above 13000FT, to TIARA, to RITLA at or  
above FL170.

RWY34L/34R : Climb on HDG 338° at or above 700FT, turn right direct to  
TORAM, to PLUTO, to KAIJI, to INTEL at or above 9000FT,  
to LAYER at or above 13000FT, to TIARA, to RITLA at or above FL170.

RWY04 : Climb on HDG 043° at or above 700FT, direct to TORAM, to PLUTO,  
to KAIJI, to INTEL at or above 9000FT, to LAYER at or above  
13000FT, to TIARA, to RITLA at or above FL170.

RWY05 : Climb on HDG 050° at or above 500FT, direct to TT501, turn right  
direct to TT502, to LOCUP at or above 5000FT, to TT503, to  
KAMAT at or above 9000FT, to LAYER at or above 13000FT, to TIARA, to  
RITLA at or above FL170.

Note RWY34L/34R/04 : 5.0% climb gradient required up to 700FT.  
RWY05 : 5.0% climb gradient required up to 500FT.

CHANGE : PROC renamed. RTE after LAYER. TIARA established. HDG after DEP FM RWY04.



## STANDARD DEPARTURE CHART-INSTRUMENT

RJTT/TOKYO INTL

RNAV SID

RITLA TWO A DEPARTURE

## RWY16R

Serial Number	Path Descriptor	Waypoint Identifier	Fly Over	Course °M(°T)	Magnetic Variation	Distance (NM)	Turn Direction	Altitude (FT)	Speed (KIAS)	Vertical Angle	Navigation Specification
001	VA	—	—	158 (150.0)	-7.6	—	—	+500	—	—	RNAV1
002	DF	T6R13	—	—	-7.6	—	—	—	—	—	RNAV1
003	TF	HATBA	—	261 (253.8)	-7.6	5.8	—	—	—	—	RNAV1
004	TF	KAMAT	—	359 (351.1)	-7.6	7.6	—	+9000	—	—	RNAV1
005	TF	LAYER	—	305 (297.1)	-7.6	12.2	—	+13000	—	—	RNAV1
006	TF	TIARA	—	279 (271.2)	-7.6	7.0	—	—	—	—	RNAV1
007	TF	RITLA	—	279 (271.1)	-7.6	9.5	—	+FL170	—	—	RNAV1

## RWY16L

Serial Number	Path Descriptor	Waypoint Identifier	Fly Over	Course °M(°T)	Magnetic Variation	Distance (NM)	Turn Direction	Altitude (FT)	Speed (KIAS)	Vertical Angle	Navigation Specification
001	VA	—	—	158 (150.0)	-7.6	—	—	+500	—	—	RNAV1
002	DF	T6L23	—	—	-7.6	—	L	—	—	—	RNAV1
003	TF	WELDA	—	055 (047.3)	-7.6	4.8	—	+6000	—	—	RNAV1
004	TF	PLUTO	—	352 (344.5)	-7.6	7.1	—	—	—	—	RNAV1
005	TF	KAIJI	—	011 (003.0)	-7.6	7.6	—	—	—	—	RNAV1
006	TF	INTEL	—	286 (278.4)	-7.6	11.9	—	+9000	—	—	RNAV1
007	TF	LAYER	—	250 (242.4)	-7.6	13.9	—	+13000	—	—	RNAV1
008	TF	TIARA	—	279 (271.2)	-7.6	7.0	—	—	—	—	RNAV1
009	TF	RITLA	—	279 (271.1)	-7.6	9.5	—	+FL170	—	—	RNAV1

## RWY34L/RWY34R

Serial Number	Path Descriptor	Waypoint Identifier	Fly Over	Course °M(°T)	Magnetic Variation	Distance (NM)	Turn Direction	Altitude (FT)	Speed (KIAS)	Vertical Angle	Navigation Specification
001	VA	—	—	338 (330.0)	-7.6	—	—	+700	—	—	RNAV1
002	DF	TORAM	—	—	-7.6	—	R	—	—	—	RNAV1
003	TF	PLUTO	—	098 (090.7)	-7.6	6.0	—	—	—	—	RNAV1
004	TF	KAIJI	—	011 (003.0)	-7.6	7.6	—	—	—	—	RNAV1
005	TF	INTEL	—	286 (278.4)	-7.6	11.9	—	+9000	—	—	RNAV1
006	TF	LAYER	—	250 (242.4)	-7.6	13.9	—	+13000	—	—	RNAV1
007	TF	TIARA	—	279 (271.2)	-7.6	7.0	—	—	—	—	RNAV1
008	TF	RITLA	—	279 (271.1)	-7.6	9.5	—	+FL170	—	—	RNAV1

CHANGE : PROC renamed. Magnetic Variation. RTE after LAYER. TIARA established.

STANDARD DEPARTURE CHART-INSTRUMENT

RJTT/TOKYO INTL

RNAV SID

CHANGE : Magnetic Variation. RTE after LAYER. TIARA established. RWY04:NR001(Course). RWY05:NR004(Course).

RWY04

Serial Number	Path Descriptor	Waypoint Identifier	Fly Over	Course °M(°T)	Magnetic Variation	Distance (NM)	Turn Direction	Altitude (FT)	Speed (KIAS)	Vertical Angle	Navigation Specification
001	VA	-	-	043 (034.9)	-7.6	-	-	+700	-	-	RNAV1
002	DF	TORAM	-	-	-7.6	-	-	-	-	-	RNAV1
003	TF	PLUTO	-	098 (090.7)	-7.6	6.0	-	-	-	-	RNAV1
004	TF	KAIJI	-	011 (003.0)	-7.6	7.6	-	-	-	-	RNAV1
005	TF	INTEL	-	286 (278.4)	-7.6	11.9	-	+9000	-	-	RNAV1
006	TF	LAYER	-	250 (242.4)	-7.6	13.9	-	+13000	-	-	RNAV1
007	TF	TIARA	-	279 (271.2)	-7.6	7.0	-	-	-	-	RNAV1
008	TF	RITLA	-	279 (271.1)	-7.6	9.5	-	+FL170	-	-	RNAV1

RWY05

Serial Number	Path Descriptor	Waypoint Identifier	Fly Over	Course °M(°T)	Magnetic Variation	Distance (NM)	Turn Direction	Altitude (FT)	Speed (KIAS)	Vertical Angle	Navigation Specification
001	VA	-	-	050 (042.4)	-7.6	-	-	+500	-	-	RNAV1
002	DF	TT501	Y	-	-7.6	-	-	-	-	-	RNAV1
003	DF	TT502	-	-	-7.6	-	R	-	-	-	RNAV1
004	TF	LOCUP	-	199 (190.9)	-7.6	5.2	-	+5000	-	-	RNAV1
005	TF	TT503	-	288 (280.8)	-7.6	6.2	-	-	-	-	RNAV1
006	TF	KAMAT	-	322 (314.2)	-7.6	7.8	-	+9000	-	-	RNAV1
007	TF	LAYER	-	305 (297.1)	-7.6	12.2	-	+13000	-	-	RNAV1
008	TF	TIARA	-	279 (271.2)	-7.6	7.0	-	-	-	-	RNAV1
009	TF	RITLA	-	279 (271.1)	-7.6	9.5	-	+FL170	-	-	RNAV1

Waypoint Coordinates

Waypoint Identifier	Coordinates	Waypoint Identifier	Coordinates
HATBA	352623.4N / 1394315.9E	T6L23	352627.6N / 1395539.1E
INTEL	354553.0N / 1394340.2E	T6R13	352800.8N / 1395006.4E
KAIJI	354409.6N / 1395806.6E	TIARA	353934.0N / 1391954.2E
KAMAT	353353.6N / 1394148.9E	TORAM	353636.8N / 1395011.0E
LAYER	353925.4N / 1392829.5E	TT501	353328.7N / 1395029.9E
LOCUP	352718.8N / 1395608.5E	TT502	353224.4N / 1395720.7E
PLUTO	353632.1N / 1395736.8E	TT503	352828.0N / 1394840.4E
RITLA	353944.8N / 1390813.1E	WELDA	352941.4N / 1395956.7E

STANDARD DEPARTURE CHART-INSTRUMENT

RJTT/TOKYO INTL

RNAV SID

RITLA TWO B DEPARTURE		RNAV1
Note 1) DME/DME/IRU or GNSS required. ※The aircraft equipped with only DME/DME/IRU must be able to update its position without delay at the starting point of take-off rolling. 2) RADAR service required.		RWY16R : HME 1.2NM FM DER - HATBA HYD 2.8NM to HATBA - 1.6NM to HATBA KAMAT - 9.2NM to LAYER PQD HATBA - 1.6NM to KAMAT KAMAT - 9.2NM to LAYER SND 11.2NM to LAYER - LAYER  RWY16L : HME 1.0NM FM DER - 3.5NM to T6L23 PQD 6.6NM to KAIJI - KAIJI NRE 6.9NM to INTEL - 6.9NM to LAYER  RWY05 : HME DER - 2.7NM to TT502 TT503 - 3.8NM to KAMAT 1.8NM to KAMAT - KAMAT HYD 1.2NM to TT503 - TT503 4.8NM to KAMAT - 3.8NM to KAMAT PQD KAMAT - 9.2NM to LAYER SND 11.2NM to LAYER - LAYER
DME GAP	RWY16R : DER - 1.2NM FM DER RWY16L : DER - 1.0NM FM DER RWY34R : DER - 1.0NM FM DER RWY05 : 3.8NM to KAMAT - 1.8NM to KAMAT	
Inappropriate Nav aids	See AD1.1.6.10.3.Inappropriate NAVAIDs for RNAV1	

VAR8°W(2020)

RITLA TWO B DEPARTURE RWY16R/16L

CHANGE : PROC renamed. VAR. RTE after LAYER. TIARA established.

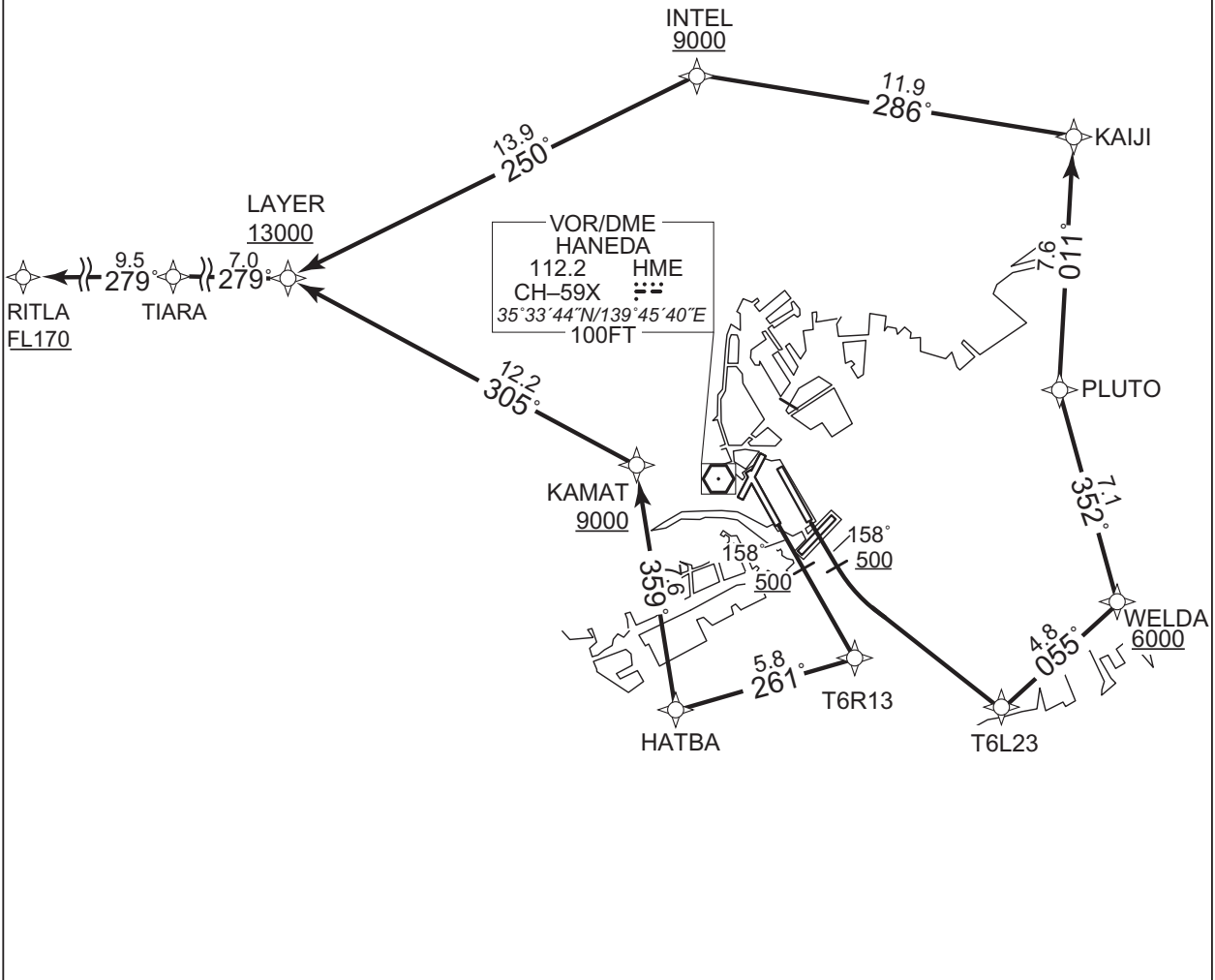

STANDARD DEPARTURE CHART-INSTRUMENT

RJTT/TOKYO INTL

RNAV SID

VAR8°W(2020)

RITLA TWO B DEPARTURE RWY 34R/05

CHANGE : PROC renamed. VAR. RTE after LAYER. TIARA established. Course FM TT502 to LOCUP.

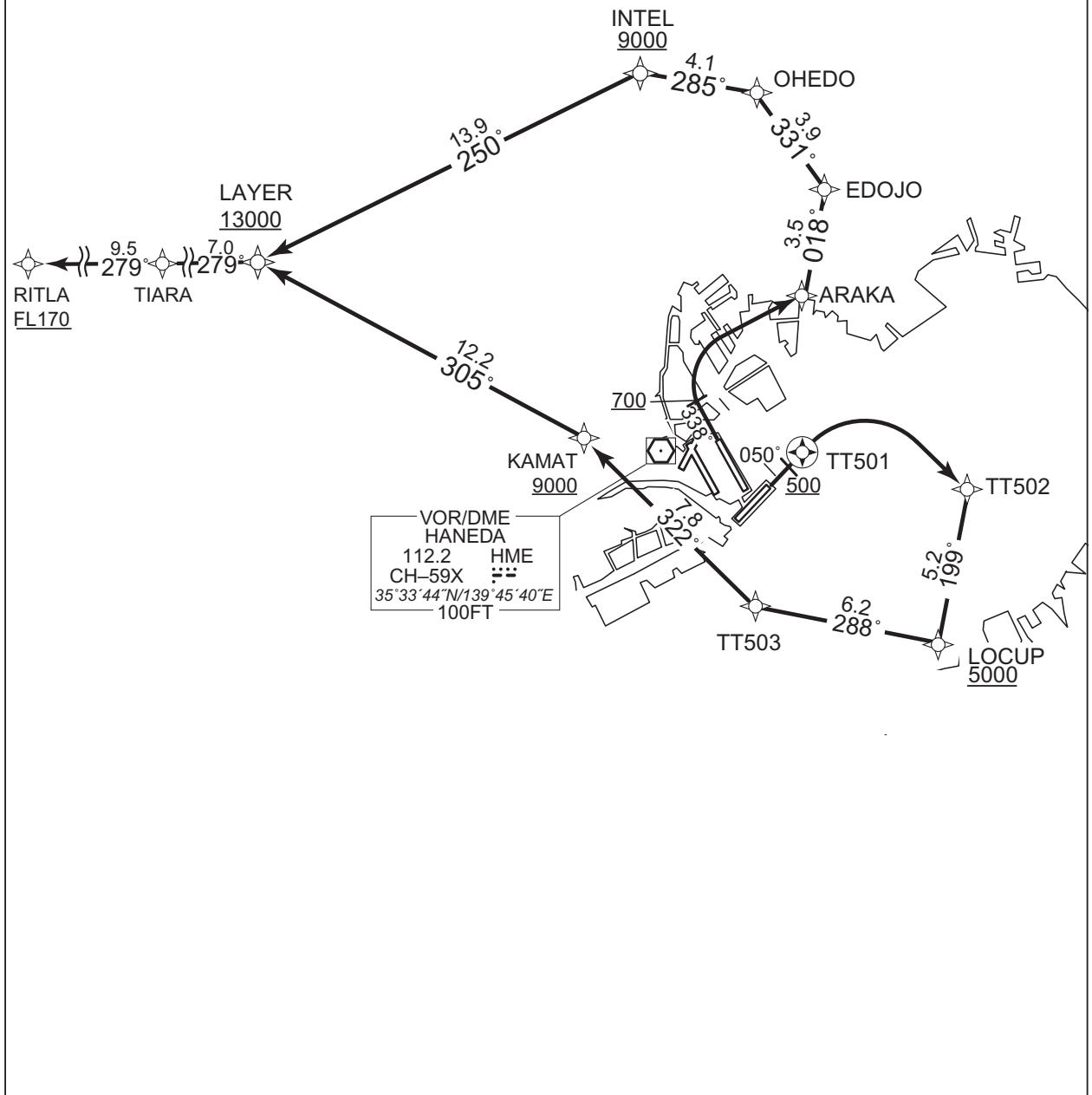

## STANDARD DEPARTURE CHART-INSTRUMENT

RJTT/TOKYO INTL

RNAV SID

RITLA TWO B DEPARTURE

RWY16R : Climb on HDG 158° at or above 500FT, direct to T6R13, to HATBA, to KAMAT at or above 9000FT, to LAYER at or above 13000FT, to TIARA, to RITLA at or above FL170.

RWY16L : Climb on HDG 158° at or above 500FT, turn left direct to T6L23, to WELDA at or above 6000FT, to PLUTO, to KAIJI, to INTEL at or above 9000FT, to LAYER at or above 13000FT, to TIARA, to RITLA at or above FL170.

RWY34R : Climb on HDG 338° at or above 700FT, turn right direct to ARAKA, to EDOJO, to OHEDO, to INTEL at or above 9000FT, to LAYER at or above 13000FT, to TIARA, to RITLA at or above FL170.

RWY05 : Climb on HDG 050° at or above 500FT, direct to TT501, turn right direct to TT502, to LOCUP at or above 5000FT, to TT503, to KAMAT at or above 9000FT, to LAYER at or above 13000FT, to TIARA, to RITLA at or above FL170.

Note RWY34R : 5.0% climb gradient required up to 700FT.

RWY05 : 5.0% climb gradient required up to 500FT.

CHANGE : PROC renamed. RTE after LAYER. TIARA established.

STANDARD DEPARTURE CHART-INSTRUMENT

RJTT/TOKYO INTL

RNAV SID

RITLA TWO B DEPARTURE

RWY16R

Serial Number	Path Descriptor	Waypoint Identifier	Fly Over	Course °M(°T)	Magnetic Variation	Distance (NM)	Turn Direction	Altitude (FT)	Speed (KIAS)	Vertical Angle	Navigation Specification
001	VA	-	-	158 (150.0)	-7.6	-	-	+500	-	-	RNAV1
002	DF	T6R13	-	-	-7.6	-	-	-	-	-	RNAV1
003	TF	HATBA	-	261 (253.8)	-7.6	5.8	-	-	-	-	RNAV1
004	TF	KAMAT	-	359 (351.1)	-7.6	7.6	-	+9000	-	-	RNAV1
005	TF	LAYER	-	305 (297.1)	-7.6	12.2	-	+13000	-	-	RNAV1
006	TF	TIARA	-	279 (271.2)	-7.6	7.0	-	-	-	-	RNAV1
007	TF	RITLA	-	279 (271.1)	-7.6	9.5	-	+FL170	-	-	RNAV1

RWY16L

Serial Number	Path Descriptor	Waypoint Identifier	Fly Over	Course °M(°T)	Magnetic Variation	Distance (NM)	Turn Direction	Altitude (FT)	Speed (KIAS)	Vertical Angle	Navigation Specification
001	VA	-	-	158 (150.0)	-7.6	-	-	+500	-	-	RNAV1
002	DF	T6L23	-	-	-7.6	-	L	-	-	-	RNAV1
003	TF	WELDA	-	055 (047.3)	-7.6	4.8	-	+6000	-	-	RNAV1
004	TF	PLUTO	-	352 (344.5)	-7.6	7.1	-	-	-	-	RNAV1
005	TF	KAIJI	-	011 (003.0)	-7.6	7.6	-	-	-	-	RNAV1
006	TF	INTEL	-	286 (278.4)	-7.6	11.9	-	+9000	-	-	RNAV1
007	TF	LAYER	-	250 (242.4)	-7.6	13.9	-	+13000	-	-	RNAV1
008	TF	TIARA	-	279 (271.2)	-7.6	7.0	-	-	-	-	RNAV1
009	TF	RITLA	-	279 (271.1)	-7.6	9.5	-	+FL170	-	-	RNAV1

RWY34R

Serial Number	Path Descriptor	Waypoint Identifier	Fly Over	Course °M(°T)	Magnetic Variation	Distance (NM)	Turn Direction	Altitude (FT)	Speed (KIAS)	Vertical Angle	Navigation Specification
001	VA	-	-	338 (330.0)	-7.6	-	-	+700	-	-	RNAV1
002	DF	ARAKA	-	-	-7.6	-	R	-	-	-	RNAV1
003	TF	EDOJO	-	018 (010.8)	-7.6	3.5	-	-	-	-	RNAV1
004	TF	OHEDO	-	331 (323.7)	-7.6	3.9	-	-	-	-	RNAV1
005	TF	INTEL	-	285 (277.0)	-7.6	4.1	-	+9000	-	-	RNAV1
006	TF	LAYER	-	250 (242.4)	-7.6	13.9	-	+13000	-	-	RNAV1
007	TF	TIARA	-	279 (271.2)	-7.6	7.0	-	-	-	-	RNAV1
008	TF	RITLA	-	279 (271.1)	-7.6	9.5	-	+FL170	-	-	RNAV1

CHANGE : PROC renamed. Magnetic Variation. RTE after LAYER. TIARA established.

STANDARD DEPARTURE CHART-INSTRUMENT

RJTT/TOKYO INTL

RNAV SID

RWY05

Serial Number	Path Descriptor	Waypoint Identifier	Fly Over	Course °M(°T)	Magnetic Variation	Distance (NM)	Turn Direction	Altitude (FT)	Speed (KIAS)	Vertical Angle	Navigation Specification
001	VA	-	-	050 (042.4)	-7.6	-	-	+500	-	-	RNAV1
002	DF	TT501	Y	-	-7.6	-	-	-	-	-	RNAV1
003	DF	TT502	-	-	-7.6	-	R	-	-	-	RNAV1
004	TF	LOCUP	-	199 (190.9)	-7.6	5.2	-	+5000	-	-	RNAV1
005	TF	TT503	-	288 (280.8)	-7.6	6.2	-	-	-	-	RNAV1
006	TF	KAMAT	-	322 (314.2)	-7.6	7.8	-	+9000	-	-	RNAV1
007	TF	LAYER	-	305 (297.1)	-7.6	12.2	-	+13000	-	-	RNAV1
008	TF	TIARA	-	279 (271.2)	-7.6	7.0	-	-	-	-	RNAV1
009	TF	RITLA	-	279 (271.1)	-7.6	9.5	-	+FL170	-	-	RNAV1

CHANGE : Magnetic Variation. RTE after LAYER. TIARA established. RWY05:NR004(Course).

Waypoint Coordinates

Waypoint Identifier	Coordinates	Waypoint Identifier	Coordinates
ARAKA	353848.8N / 1395041.9E	PLUTO	353632.1N / 1395736.8E
EDOJO	354214.0N / 1395129.9E	RITLA	353944.8N / 1390813.1E
HATBA	352623.4N / 1394315.9E	T6L23	352627.6N / 1395539.1E
INTEL	354553.0N / 1394340.2E	T6R13	352800.8N / 1395006.4E
KAIJI	354409.6N / 1395806.6E	TIARA	353934.0N / 1391954.2E
KAMAT	353353.6N / 1394148.9E	TT501	353328.7N / 1395029.9E
LAYER	353925.4N / 1392829.5E	TT502	353224.4N / 1395720.7E
LOCUP	352718.8N / 1395608.5E	TT503	352828.0N / 1394840.4E
OHEDO	354523.4N / 1394838.6E	WELDA	352941.4N / 1395956.7E

STANDARD DEPARTURE CHART-INSTRUMENT

RJTT/TOKYO INTL		RITLA TWO C DEPARTURE		RNAV SID
				RNAV1
Note 1) DME/DME/IRU or GNSS required. ※The aircraft equipped with only DME/DME/IRU must be able to update its position without delay at the starting point of take-off rolling. 2) RADAR service required.				RWY16R : HME 1.2NM FM DER - 1.9NM to T6R11 PQD 6.6NM to KAIJI - KAIJI NRE 6.9NM to INTEL - 6.9NM to LAYER RWY16L : HME 1.0NM FM DER - 3.5NM to T6L23 PQD 6.6NM to KAIJI - KAIJI NRE 6.9NM to INTEL - 6.9NM to LAYER RWY05 : HME DER - 2.7NM to TT502 TT503 - 3.8NM to KAMAT 1.8NM to KAMAT - KAMAT HYD 1.2NM to TT503 - TT503 4.8NM to KAMAT - 3.8NM to KAMAT PQD KAMAT - 9.2NM to LAYER SND 11.2NM to LAYER - LAYER
DME GAP	RWY16R : DER - 1.2NM FM DER RWY16L : DER - 1.0NM FM DER RWY34R : DER - 1.0NM FM DER RWY05 : 3.8NM to KAMAT - 1.8NM to KAMAT RWY22 : DER - 1.4NM FM DER	Critical DME		
Inappropriate Nav aids	See AD1.1.6.10.3.Inappropriate NAVAIDS for RNAV1			

CHANGE : PROC renamed. VAR: RTE after LAYER. TIARA established. HDG after DEP FM RWY22. Course FM BASSA to UMUKI.

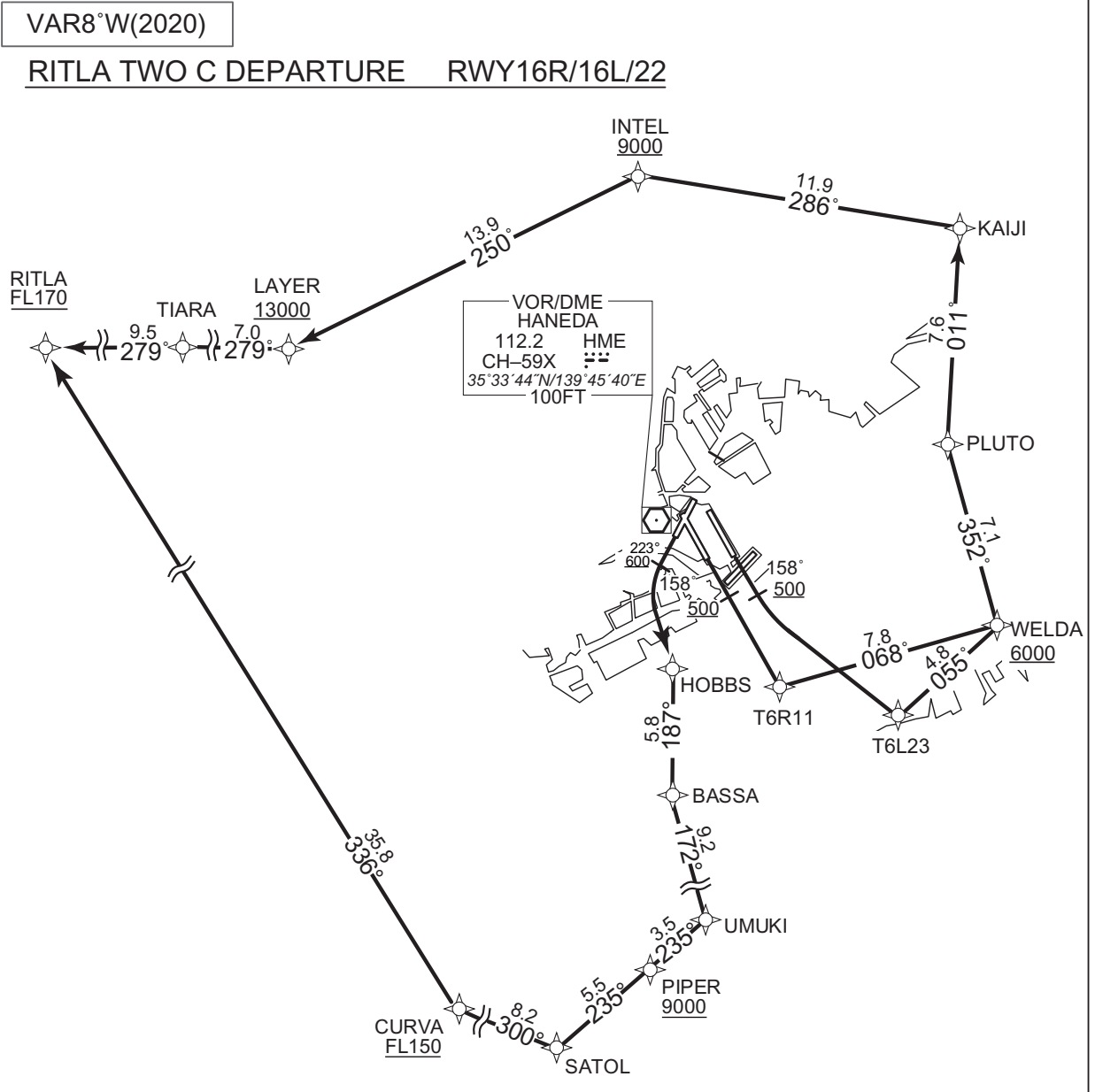



STANDARD DEPARTURE CHART-INSTRUMENT

RJTT/TOKYO INTL

RNAV SID

VAR8°W(2020)

RITLA TWO C DEPARTURE RWY 34R/05

CHANGE : PROC renamed. VAR. RTE after LAYER. TIARA established. Course FM TT502 to LOCUP.

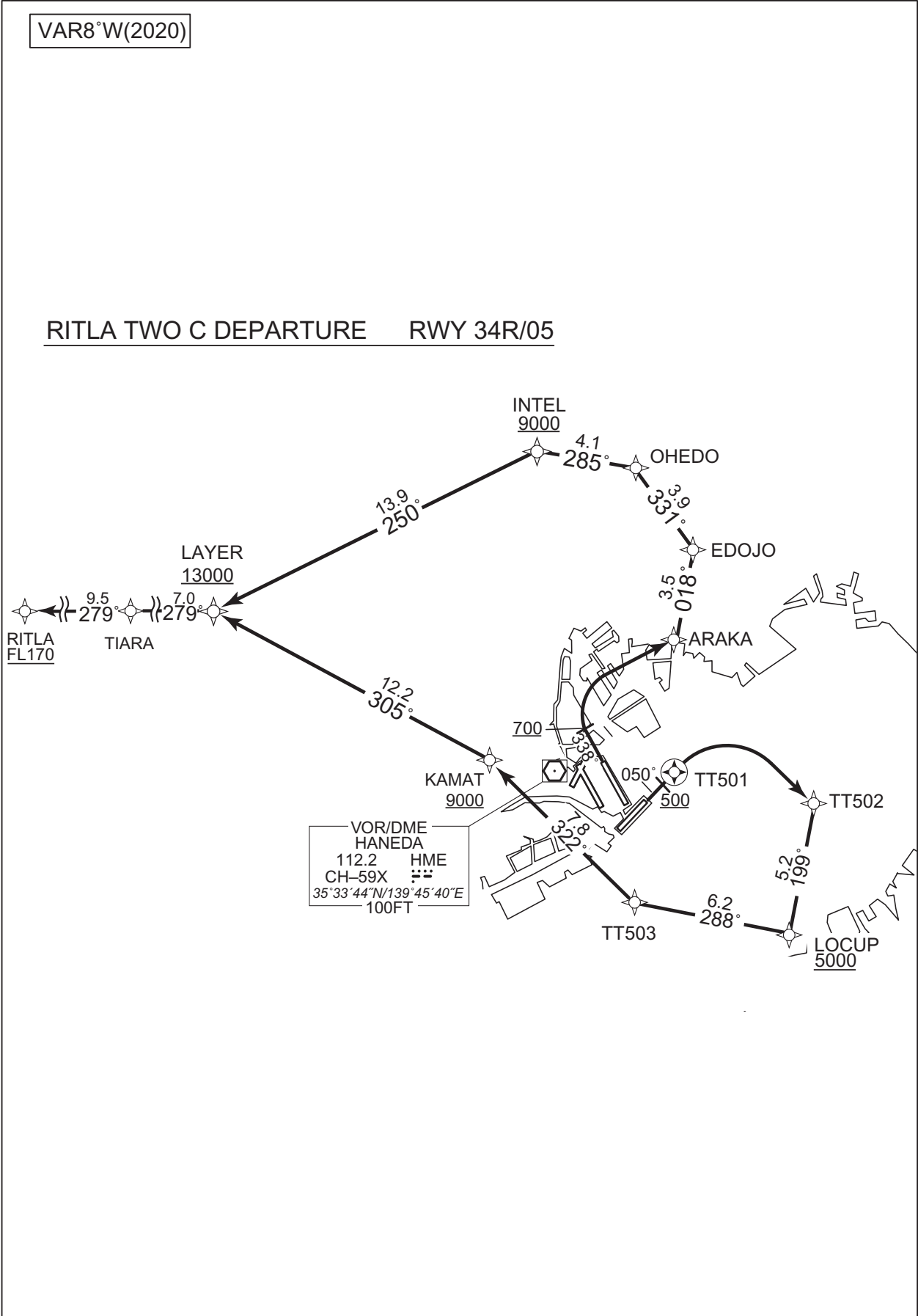

STANDARD DEPARTURE CHART-INSTRUMENT

RJTT/TOKYO INTL

RNAV SID

RITLA TWO C DEPARTURE

RWY16R : Climb on HDG 158° at or above 500FT, direct to T6R11,  
to WELDA at or above 6000FT, to PLUTO, to KAIJI, to INTEL  
at or above 9000FT, to LAYER at or above 13000FT, to TIARA, to RITLA  
at or above FL170.

RWY16L : Climb on HDG 158° at or above 500FT, turn left direct to T6L23,  
to WELDA at or above 6000FT, to PLUTO, to KAIJI, to INTEL at or  
above 9000FT, to LAYER at or above 13000FT, to TIARA, to RITLA at or  
above FL170.

RWY34R : Climb on HDG 338° at or above 700FT, turn right direct to ARAKA,  
to EDOJO, to OHEDO, to INTEL at or above 9000FT, to LAYER  
at or above 13000FT, to TIARA, to RITLA at or above FL170.

RWY05 : Climb on HDG 050° at or above 500FT, direct to TT501, turn right  
direct to TT502, to LOCUP at or above 5000FT, to TT503, to  
KAMAT at or above 9000FT, to LAYER at or above 13000FT, to TIARA, to  
RITLA at or above FL170.

RWY22 : Climb on HDG 223° at or above 600FT, turn left direct to HOBBS,  
to BASSA, to UMUKI, to PIPER at or above 9000FT, to SATOL,  
to CURVA at or above FL150, to RITLA at or above FL170.

Note RWY34R : 5.0% climb gradient required up to 700FT.  
RWY05 : 5.0% climb gradient required up to 500FT.  
RWY22 : 5.0% climb gradient required up to 600FT.

CHANGE : PROC renamed. RTE after LAYER. TIARA established. HDG after DEP FM RWY22.

STANDARD DEPARTURE CHART-INSTRUMENT

RJTT/TOKYO INTL

RNAV SID

RITLA TWO C DEPARTURE

RWY16R

Serial Number	Path Descriptor	Waypoint Identifier	Fly Over	Course °M(°T)	Magnetic Variation	Distance (NM)	Turn Direction	Altitude (FT)	Speed (KIAS)	Vertical Angle	Navigation Specification
001	VA	-	-	158 (150.0)	-7.6	-	-	+500	-	-	RNAV1
002	DF	T6R11	-	-	-7.6	-	-	-	-	-	RNAV1
003	TF	WELDA	-	068 (060.6)	-7.6	7.8	-	+6000	-	-	RNAV1
004	TF	PLUTO	-	352 (344.5)	-7.6	7.1	-	-	-	-	RNAV1
005	TF	KAIJI	-	011 (003.0)	-7.6	7.6	-	-	-	-	RNAV1
006	TF	INTEL	-	286 (278.4)	-7.6	11.9	-	+9000	-	-	RNAV1
007	TF	LAYER	-	250 (242.4)	-7.6	13.9	-	+13000	-	-	RNAV1
008	TF	TIARA	-	279 (271.2)	-7.6	7.0	-	-	-	-	RNAV1
009	TF	RITLA	-	279 (271.1)	-7.6	9.5	-	+FL170	-	-	RNAV1

RWY16L

Serial Number	Path Descriptor	Waypoint Identifier	Fly Over	Course °M(°T)	Magnetic Variation	Distance (NM)	Turn Direction	Altitude (FT)	Speed (KIAS)	Vertical Angle	Navigation Specification
001	VA	-	-	158 (150.0)	-7.6	-	-	+500	-	-	RNAV1
002	DF	T6L23	-	-	-7.6	-	L	-	-	-	RNAV1
003	TF	WELDA	-	055 (047.3)	-7.6	4.8	-	+6000	-	-	RNAV1
004	TF	PLUTO	-	352 (344.5)	-7.6	7.1	-	-	-	-	RNAV1
005	TF	KAIJI	-	011 (003.0)	-7.6	7.6	-	-	-	-	RNAV1
006	TF	INTEL	-	286 (278.4)	-7.6	11.9	-	+9000	-	-	RNAV1
007	TF	LAYER	-	250 (242.4)	-7.6	13.9	-	+13000	-	-	RNAV1
008	TF	TIARA	-	279 (271.2)	-7.6	7.0	-	-	-	-	RNAV1
009	TF	RITLA	-	279 (271.1)	-7.6	9.5	-	+FL170	-	-	RNAV1

RWY34R

Serial Number	Path Descriptor	Waypoint Identifier	Fly Over	Course °M(°T)	Magnetic Variation	Distance (NM)	Turn Direction	Altitude (FT)	Speed (KIAS)	Vertical Angle	Navigation Specification
001	VA	-	-	338 (330.0)	-7.6	-	-	+700	-	-	RNAV1
002	DF	ARAKA	-	-	-7.6	-	R	-	-	-	RNAV1
003	TF	EDOJO	-	018 (010.8)	-7.6	3.5	-	-	-	-	RNAV1
004	TF	OHEDO	-	331 (323.7)	-7.6	3.9	-	-	-	-	RNAV1
005	TF	INTEL	-	285 (277.0)	-7.6	4.1	-	+9000	-	-	RNAV1
006	TF	LAYER	-	250 (242.4)	-7.6	13.9	-	+13000	-	-	RNAV1
007	TF	TIARA	-	279 (271.2)	-7.6	7.0	-	-	-	-	RNAV1
008	TF	RITLA	-	279 (271.1)	-7.6	9.5	-	+FL170	-	-	RNAV1

CHANGE : PROC renamed. Magnetic Variation. RTE after LAYER. TIARA established.

STANDARD DEPARTURE CHART-INSTRUMENT

RJTT/TOKYO INTL

RNAV SID

RWY05

Serial Number	Path Descriptor	Waypoint Identifier	Fly Over	Course °M(°T)	Magnetic Variation	Distance (NM)	Turn Direction	Altitude (FT)	Speed (KIAS)	Vertical Angle	Navigation Specification
001	VA	-	-	050 (042.4)	-7.6	-	-	+500	-	-	RNAV1
002	DF	TT501	Y	-	-7.6	-	-	-	-	-	RNAV1
003	DF	TT502	-	-	-7.6	-	R	-	-	-	RNAV1
004	TF	LOCUP	-	199 (190.9)	-7.6	5.2	-	+5000	-	-	RNAV1
005	TF	TT503	-	288 (280.8)	-7.6	6.2	-	-	-	-	RNAV1
006	TF	KAMAT	-	322 (314.2)	-7.6	7.8	-	+9000	-	-	RNAV1
007	TF	LAYER	-	305 (297.1)	-7.6	12.2	-	+13000	-	-	RNAV1
008	TF	TIARA	-	279 (271.2)	-7.6	7.0	-	-	-	-	RNAV1
009	TF	RITLA	-	279 (271.1)	-7.6	9.5	-	+FL170	-	-	RNAV1

RWY22

Serial Number	Path Descriptor	Waypoint Identifier	Fly Over	Course °M(°T)	Magnetic Variation	Distance (NM)	Turn Direction	Altitude (FT)	Speed (KIAS)	Vertical Angle	Navigation Specification
001	VA	-	-	223 (214.9)	-7.6	-	-	+600	-	-	RNAV1
002	DF	HOBBS	-	-	-7.6	-	L	-	-	-	RNAV1
003	TF	BASSA	-	187 (179.9)	-7.6	5.8	-	-	-	-	RNAV1
004	TF	UMUKI	-	172 (163.9)	-7.6	9.2	-	-	-	-	RNAV1
005	TF	PIPER	-	235 (227.4)	-7.6	3.5	-	+9000	-	-	RNAV1
006	TF	SATOL	-	235 (227.4)	-7.6	5.5	-	-	-	-	RNAV1
007	TF	CURVA	-	300 (292.2)	-7.6	8.2	-	+FL150	-	-	RNAV1
008	TF	RITLA	-	336 (328.3)	-7.6	35.8	-	+FL170	-	-	RNAV1

Waypoint Coordinates

Waypoint Identifier	Coordinates	Waypoint Identifier	Coordinates
ARAKA	353848.8N / 1395041.9E	PLUTO	353632.1N / 1395736.8E
BASSA	352108.8N / 1394542.2E	RITLA	353944.8N / 1390813.1E
CURVA	350919.0N / 1393124.4E	SATOL	350613.3N / 1394043.4E
EDOJO	354214.0N / 1395129.9E	T6L23	352627.6N / 1395539.1E
HOBBS	352653.9N / 1394541.3E	T6R11	352552.5N / 1395137.2E
INTEL	354553.0N / 1394340.2E	TIARA	353934.0N / 1391954.2E
KAIJI	354409.6N / 1395806.6E	TT501	353328.7N / 1395029.9E
KAMAT	353353.6N / 1394148.9E	TT502	353224.4N / 1395720.7E
LAYER	353925.4N / 1392829.5E	TT503	352828.0N / 1394840.4E
LOCUP	352718.8N / 1395608.5E	UMUKI	351219.1N / 1394849.2E
OHEDO	354523.4N / 1394838.6E	WELDA	352941.4N / 1395956.7E
PIPER	350958.3N / 1394542.0E		

CHANGE : : Magnetic Variation. RTE after LAYER. TIARA established. RWY05:NR004(Course). RWY22:NR001,004(Course).

STANDARD DEPARTURE CHART-INSTRUMENT

RJTT/TOKYO INTL

RNAV SID

BEKLA TWO A DEPARTURE

RNAV1

Note 1) DME/DME/IRU or GNSS required.  
 ※The aircraft equipped with only DME/DME/IRU must be able to update its position without delay at the starting point of take-off rolling.  
 2) RADAR service required.

DME GAP	RWY16R : DER - 1.2NM FM DER RWY16L : DER - 1.0NM FM DER RWY34R : DER - 1.0NM FM DER RWY34L : DER - 0.5NM FM DER RWY04 : DER - 1.7NM FM DER RWY05 : 3.8NM to KAMAT - 1.8NM to KAMAT
	Inappropriate Nav aids See AD1.1.6.10.3.Inappropriate NAVAIDs for RNAV1

Critical DME	RWY16R : HME 1.2NM FM DER - HATBA HYD 2.8NM to HATBA - 1.6NM to HATBA PQD HATBA - 1.6NM to KAMAT
	RWY16L : HME 1.0NM FM DER - 3.5NM to T6L23 PQD 6.6NM to KAIJI - KAIJI NRE 6.9NM to INTEL - INTEL
	RWY34R : HME 1.0NM FM DER - 1.1NM to PLUTO SND TORAM - 3.1NM to PLUTO PQD 6.6NM to KAIJI - KAIJI NRE 6.9NM to INTEL - INTEL
	RWY34L : HME 0.5NM FM DER - 1.1NM to PLUTO SND TORAM - 3.1NM to PLUTO PQD 6.6NM to KAIJI - KAIJI NRE 6.9NM to INTEL - INTEL
	RWY04 : HME 1.7NM FM DER - 1.1NM to PLUTO SND 2.2NM to TORAM - 3.1NM to PLUTO PQD 6.6NM to KAIJI - KAIJI NRE 6.9NM to INTEL - INTEL
	RWY05 : HME DER - 2.7NM to TT502 TT503 - 3.8NM to KAMAT 1.8NM to KAMAT - KAMAT HYD 1.2NM to TT503 - TT503 4.8NM to KAMAT - 3.8NM to KAMAT

VAR8°W(2020)

BEKLA TWO A DEPARTURE RWY16R/16L

CHANGE : PROC renamed. VAR. RTE after KAMAT.

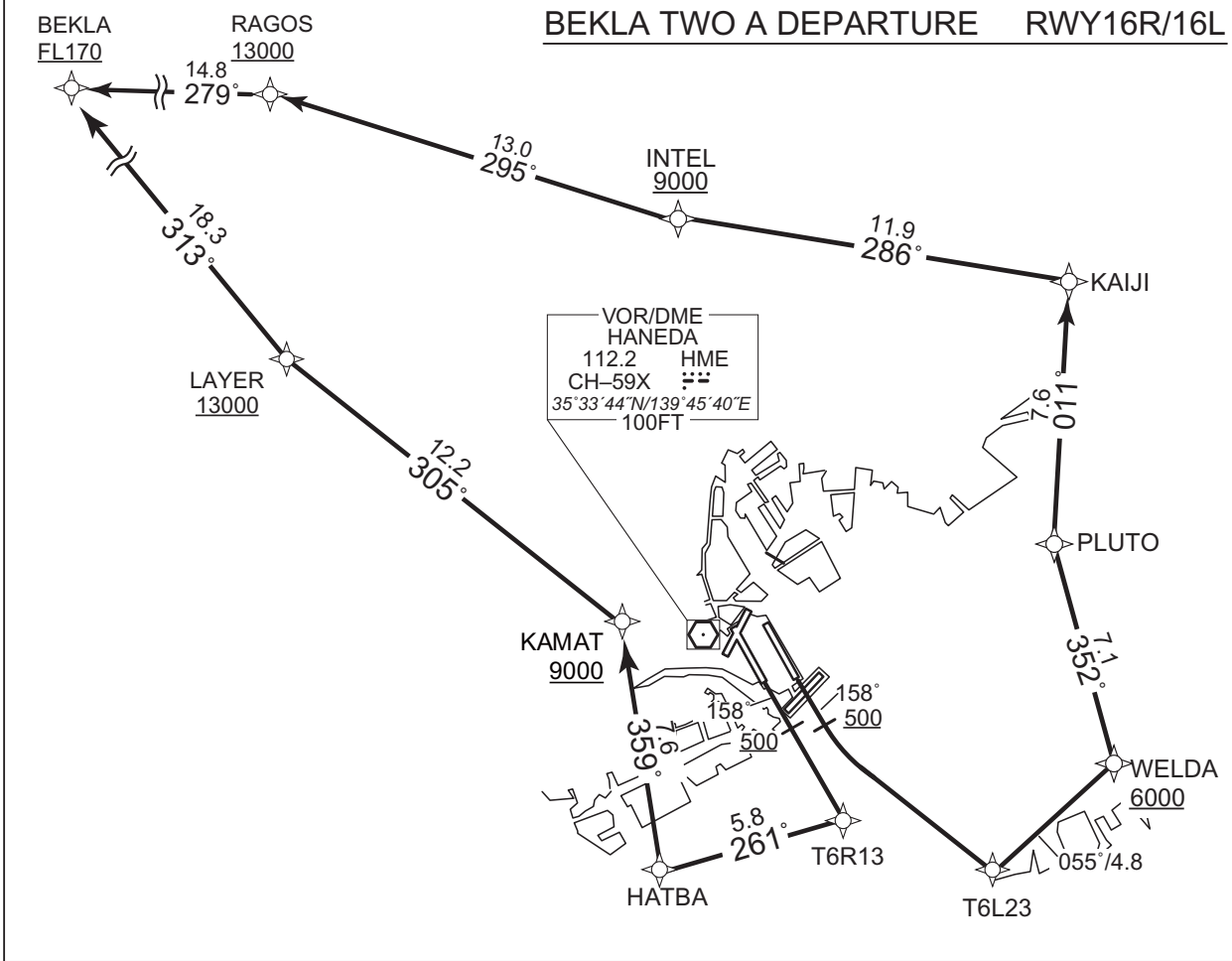

STANDARD DEPARTURE CHART-INSTRUMENT

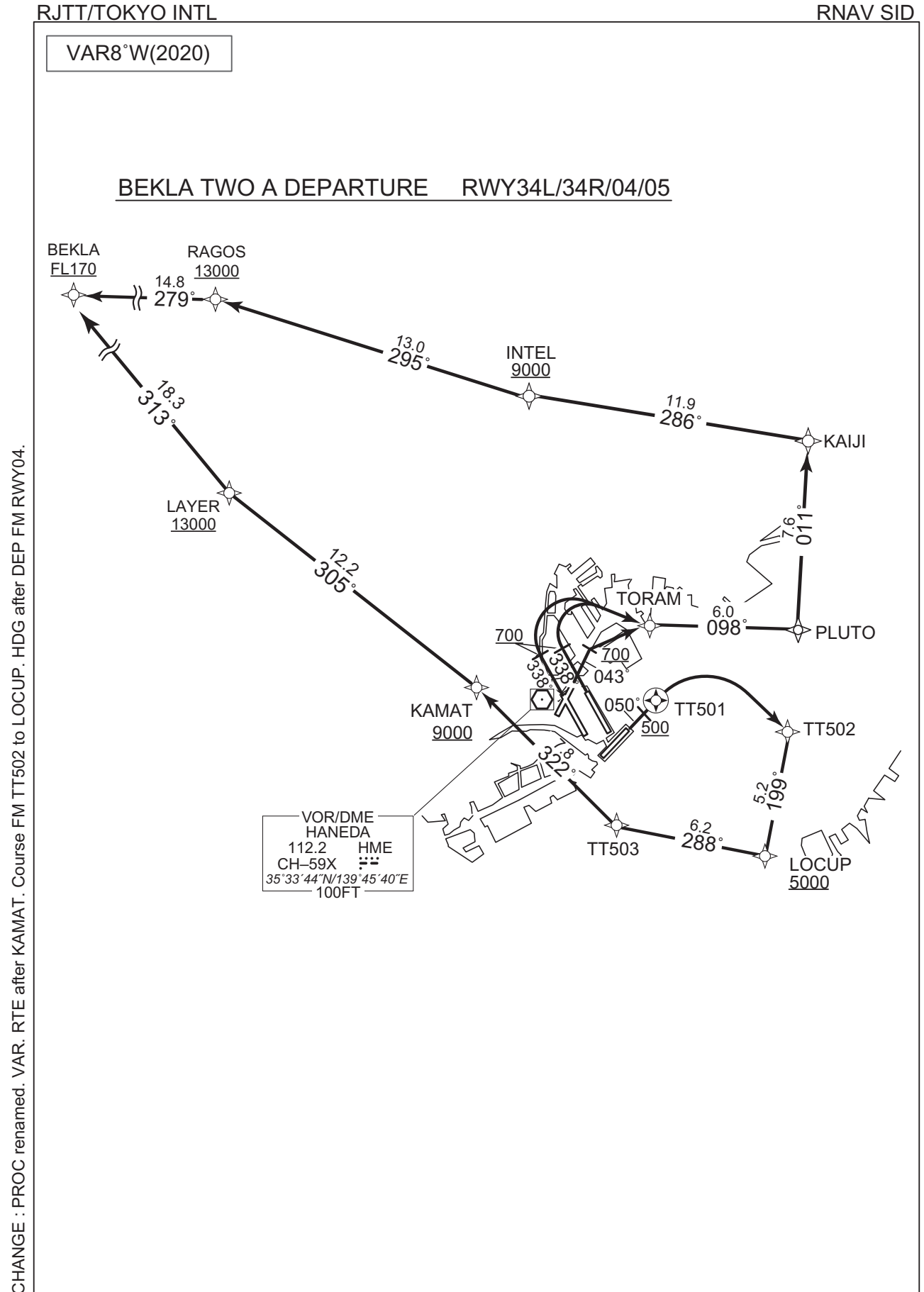

## STANDARD DEPARTURE CHART-INSTRUMENT

RJTT/TOKYO INTL

RNAV SID

BEKLA TWO A DEPARTURE

RWY16R : Climb on HDG 158° at or above 500FT, direct to T6R13, to HATBA, to KAMAT at or above 9000FT, to LAYER at or above 13000FT, to BEKLA at or above FL170.

RWY16L : Climb on HDG 158° at or above 500FT, turn left direct to T6L23, to WELDA at or above 6000FT, to PLUTO, to KAIJI, to INTEL at or above 9000FT, to RAGOS at or above 13000FT, to BEKLA at or above FL170.

RWY34L/34R : Climb on HDG 338° at or above 700FT, turn right direct to TORAM, to PLUTO, to KAIJI, to INTEL at or above 9000FT, to RAGOS at or above 13000FT, to BEKLA at or above FL170.

RWY04 : Climb on HDG 043° at or above 700FT, direct to TORAM, to PLUTO, to KAIJI, to INTEL at or above 9000FT, to RAGOS at or above 13000FT, to BEKLA at or above FL170.

RWY05 : Climb on HDG 050° at or above 500FT, direct to TT501, turn right direct to TT502, to LOCUP at or above 5000FT, to TT503, to KAMAT at or above 9000FT, to LAYER at or above 13000FT, to BEKLA at or above FL170.

Note RWY34L/34R/04 : 5.0% climb gradient required up to 700FT.  
RWY05 : 5.0% climb gradient required up to 500FT.

CHANGE : PROC renamed. RTE after KAMAT(RWY16R.05). HDG after DEP FM RWY04.

STANDARD DEPARTURE CHART-INSTRUMENT

RJTT/TOKYO INTL

RNAV SID

BEKLA TWO A DEPARTURE

RWY16R

Serial Number	Path Descriptor	Waypoint Identifier	Fly Over	Course °M(°T)	Magnetic Variation	Distance (NM)	Turn Direction	Altitude (FT)	Speed (KIAS)	Vertical Angle	Navigation Specification
001	VA	-	-	158 (150.0)	-7.6	-	-	+500	-	-	RNAV1
002	DF	T6R13	-	-	-7.6	-	-	-	-	-	RNAV1
003	TF	HATBA	-	261 (253.8)	-7.6	5.8	-	-	-	-	RNAV1
004	TF	KAMAT	-	359 (351.1)	-7.6	7.6	-	+9000	-	-	RNAV1
005	TF	LAYER	-	305 (297.1)	-7.6	12.2	-	+13000	-	-	RNAV1
006	TF	BEKLA	-	313 (305.4)	-7.6	18.3	-	+FL170	-	-	RNAV1

RWY16L

Serial Number	Path Descriptor	Waypoint Identifier	Fly Over	Course °M(°T)	Magnetic Variation	Distance (NM)	Turn Direction	Altitude (FT)	Speed (KIAS)	Vertical Angle	Navigation Specification
001	VA	-	-	158 (150.0)	-7.6	-	-	+500	-	-	RNAV1
002	DF	T6L23	-	-	-7.6	-	L	-	-	-	RNAV1
003	TF	WELDA	-	055 (047.3)	-7.6	4.8	-	+6000	-	-	RNAV1
004	TF	PLUTO	-	352 (344.5)	-7.6	7.1	-	-	-	-	RNAV1
005	TF	KAIJI	-	011 (003.0)	-7.6	7.6	-	-	-	-	RNAV1
006	TF	INTEL	-	286 (278.4)	-7.6	11.9	-	+9000	-	-	RNAV1
007	TF	RAGOS	-	295 (287.2)	-7.6	13.0	-	+13000	-	-	RNAV1
008	TF	BEKLA	-	279 (271.2)	-7.6	14.8	-	+FL170	-	-	RNAV1

RWY34L/RWY34R

Serial Number	Path Descriptor	Waypoint Identifier	Fly Over	Course °M(°T)	Magnetic Variation	Distance (NM)	Turn Direction	Altitude (FT)	Speed (KIAS)	Vertical Angle	Navigation Specification
001	VA	-	-	338 (330.0)	-7.6	-	-	+700	-	-	RNAV1
002	DF	TORAM	-	-	-7.6	-	R	-	-	-	RNAV1
003	TF	PLUTO	-	098 (090.7)	-7.6	6.0	-	-	-	-	RNAV1
004	TF	KAIJI	-	011 (003.0)	-7.6	7.6	-	-	-	-	RNAV1
005	TF	INTEL	-	286 (278.4)	-7.6	11.9	-	+9000	-	-	RNAV1
006	TF	RAGOS	-	295 (287.2)	-7.6	13.0	-	+13000	-	-	RNAV1
007	TF	BEKLA	-	279 (271.2)	-7.6	14.8	-	+FL170	-	-	RNAV1

CHANGE : PROC renamed. Magnetic Variation. RWY16R: RTE after KAMAT.



STANDARD DEPARTURE CHART-INSTRUMENT

RJTT/TOKYO INTL

RNAV SID

RWY04

Serial Number	Path Descriptor	Waypoint Identifier	Fly Over	Course °M(T)	Magnetic Variation	Distance (NM)	Turn Direction	Altitude (FT)	Speed (KIAS)	Vertical Angle	Navigation Specification
001	VA	-	-	043 (034.9)	-7.6	-	-	+700	-	-	RNAV1
002	DF	TORAM	-	-	-7.6	-	-	-	-	-	RNAV1
003	TF	PLUTO	-	098 (090.7)	-7.6	6.0	-	-	-	-	RNAV1
004	TF	KAIJI	-	011 (003.0)	-7.6	7.6	-	-	-	-	RNAV1
005	TF	INTEL	-	286 (278.4)	-7.6	11.9	-	+9000	-	-	RNAV1
006	TF	RAGOS	-	295 (287.2)	-7.6	13.0	-	+13000	-	-	RNAV1
007	TF	BEKLA	-	279 (271.2)	-7.6	14.8	-	+FL170	-	-	RNAV1

RWY05

Serial Number	Path Descriptor	Waypoint Identifier	Fly Over	Course °M(T)	Magnetic Variation	Distance (NM)	Turn Direction	Altitude (FT)	Speed (KIAS)	Vertical Angle	Navigation Specification
001	VA	-	-	050 (042.4)	-7.6	-	-	+500	-	-	RNAV1
002	DF	TT501	Y	-	-7.6	-	-	-	-	-	RNAV1
003	DF	TT502	-	-	-7.6	-	R	-	-	-	RNAV1
004	TF	LOCUP	-	199 (190.9)	-7.6	5.2	-	+5000	-	-	RNAV1
005	TF	TT503	-	288 (280.8)	-7.6	6.2	-	-	-	-	RNAV1
006	TF	KAMAT	-	322 (314.2)	-7.6	7.8	-	+9000	-	-	RNAV1
007	TF	LAYER	-	305 (297.1)	-7.6	12.2	-	+13000	-	-	RNAV1
008	TF	BEKLA	-	313 (305.4)	-7.6	18.3	-	+FL170	-	-	RNAV1

Waypoint Coordinates

Waypoint Identifier	Coordinates	Waypoint Identifier	Coordinates
BEKLA	354958.7N / 1391009.5E	RAGOS	354942.2N / 1392821.2E
HATBA	352623.4N / 1394315.9E	T6L23	352627.6N / 1395539.1E
INTEL	354553.0N / 1394340.2E	T6R13	352800.8N / 1395006.4E
KAIJI	354409.6N / 1395806.6E	TORAM	353636.8N / 1395011.0E
KAMAT	353353.6N / 1394148.9E	TT501	353328.7N / 1395029.9E
LAYER	353925.4N / 1392829.5E	TT502	353224.4N / 1395720.7E
LOCUP	352718.8N / 1395608.5E	TT503	352828.0N / 1394840.4E
PLUTO	353632.1N / 1395736.8E	WELDA	352941.4N / 1395956.7E

CHANGE : Magnetic Variation. RWY04:NR001(Course). RWY05:NR004(Course). RTE after KAMAT. Waypoint Coordinates(LAYER added).

STANDARD DEPARTURE CHART-INSTRUMENT

RJTT/TOKYO INTL

RNAV SID

BEKLA TWO B DEPARTURE		RNAV1
Note 1) DME/DME/IRU or GNSS required. ※The aircraft equipped with only DME/DME/IRU must be able to update its position without delay at the starting point of take-off rolling. 2) RADAR service required.		RWY16R : HME 1.2NM FM DER - HATBA HYD 2.8NM to HATBA - 1.6NM to HATBA PQD HATBA - 1.6NM to KAMAT RWY16L : HME 1.0NM FM DER - 3.5NM to T6L23 PQD 6.6NM to KAIJI - KAIJI NRE 6.9NM to INTEL - INTEL RWY05 : HME DER - 2.7NM to TT502 TT503 - 3.8NM to KAMAT 1.8NM to KAMAT - KAMAT HYD 1.2NM to TT503 - TT503 4.8NM to KAMAT - 3.8NM to KAMAT
DME GAP	RWY16R : DER - 1.2NM FM DER RWY16L : DER - 1.0NM FM DER RWY34R : DER - 1.0NM FM DER RWY05 : 3.8NM to KAMAT - 1.8NM to KAMAT	
Inappropriate Nav aids	See AD1.1.6.10.3.Inappropriate NAVAIDs for RNAV1	

VAR8°W(2020)

BEKLA TWO B DEPARTURE RWY16R/16L

CHANGE : PROC renamed. VAR. RTE after KAMAT.

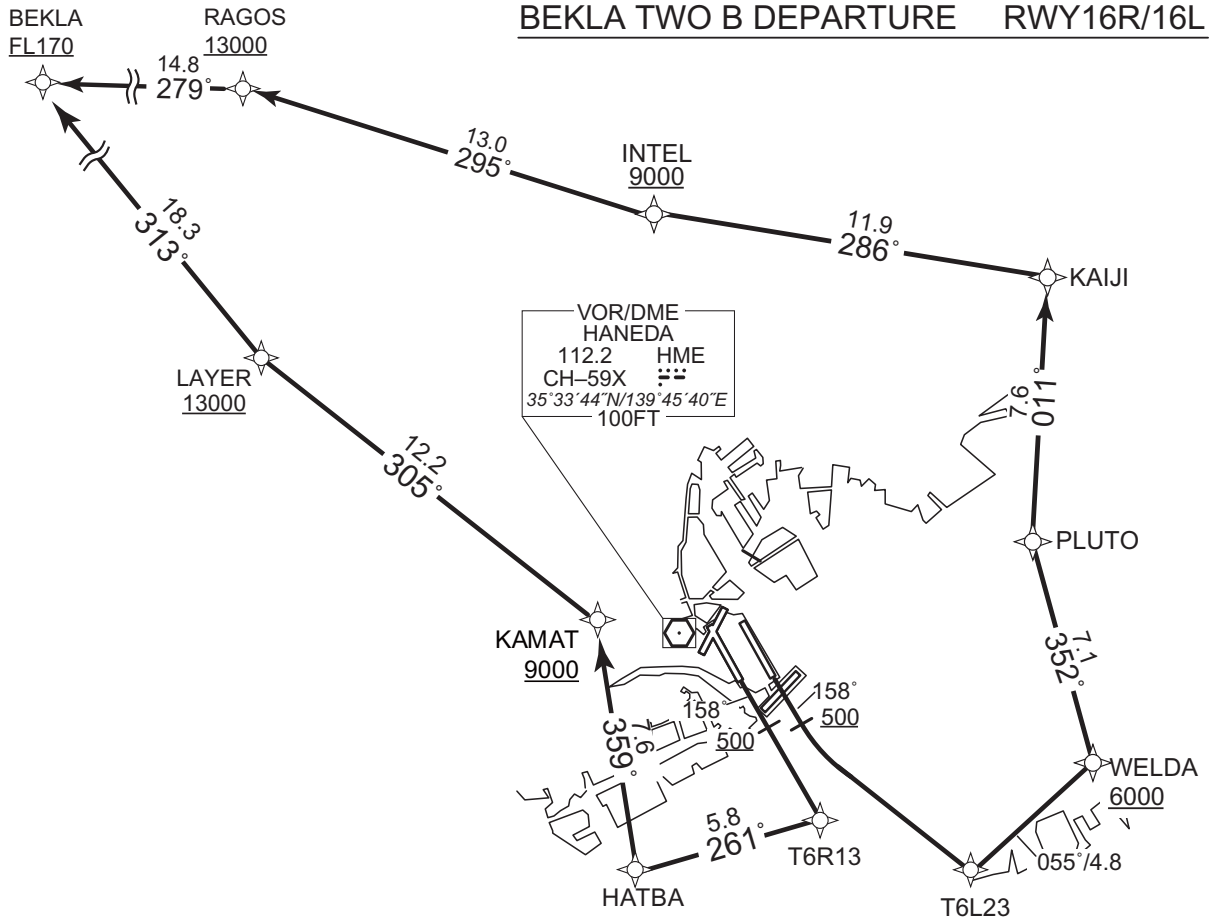

STANDARD DEPARTURE CHART-INSTRUMENT

RJTT/TOKYO INTL

RNAV SID

VAR8°W(2020)

BEKLA TWO B DEPARTURE RWY34R/05

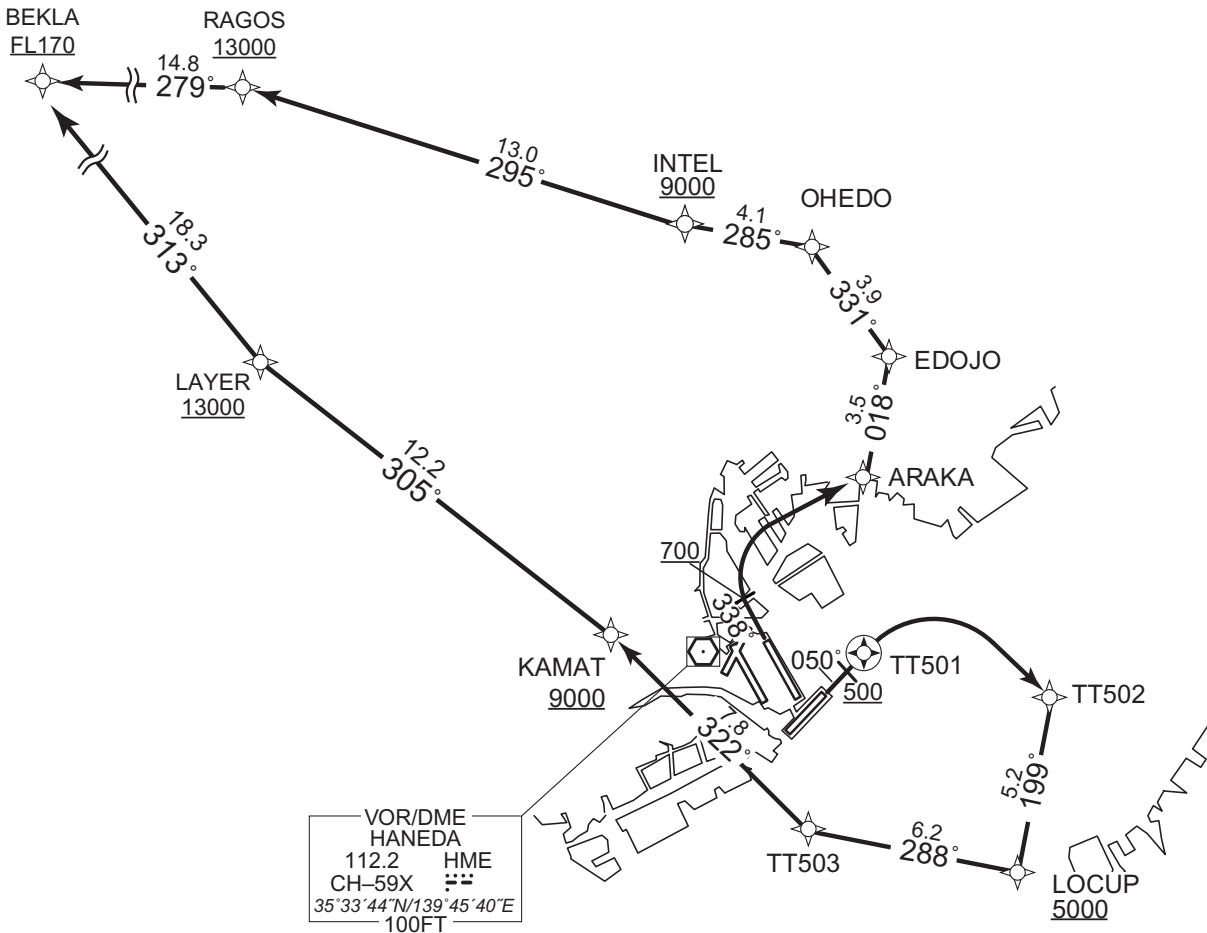

CHANGE : PROC renamed. VAR. RTE after KAMAT. Course FM TT502 to LOCUP.

STANDARD DEPARTURE CHART-INSTRUMENT

RJTT/TOKYO INTL

RNAV SID

BEKLA TWO B DEPARTURE

RWY16R : Climb on HDG 158° at or above 500FT, direct to T6R13, to HATBA, to KAMAT at or above 9000FT, to LAYER at or above 13000FT, to BEKLA at or above FL170.

RWY16L : Climb on HDG 158° at or above 500FT, turn left direct to T6L23, to WELDA at or above 6000FT, to PLUTO, to KAIJI, to INTEL at or above 9000FT, to RAGOS at or above 13000FT, to BEKLA at or above FL170.

RWY34R : Climb on HDG 338° at or above 700FT, turn right direct to ARAKA, to EDOJO, to OHEDO, to INTEL at or above 9000FT, to RAGOS at or above 13000FT, to BEKLA at or above FL170.

RWY05 : Climb on HDG 050° at or above 500FT, direct to TT501, turn right direct to TT502, to LOCUP at or above 5000FT, to TT503, to KAMAT at or above 9000FT, to LAYER at or above 13000FT, to BEKLA at or above FL170.

Note RWY34R : 5.0% climb gradient required up to 700FT.

RWY05 : 5.0% climb gradient required up to 500FT.

CHANGE : PROC renamed. RTE after KAMAT (RWY16R,05).

STANDARD DEPARTURE CHART-INSTRUMENT

RJTT/TOKYO INTL

RNAV SID

BEKLA TWO B DEPARTURE

RWY16R

Serial Number	Path Descriptor	Waypoint Identifier	Fly Over	Course °M(T)	Magnetic Variation	Distance (NM)	Turn Direction	Altitude (FT)	Speed (KIAS)	Vertical Angle	Navigation Specification
001	VA	-	-	158 (150.0)	-7.6	-	-	+500	-	-	RNAV1
002	DF	T6R13	-	-	-7.6	-	-	-	-	-	RNAV1
003	TF	HATBA	-	261 (253.8)	-7.6	5.8	-	-	-	-	RNAV1
004	TF	KAMAT	-	359 (351.1)	-7.6	7.6	-	+9000	-	-	RNAV1
005	TF	LAYER	-	305 (297.1)	-7.6	12.2	-	+13000	-	-	RNAV1
006	TF	BEKLA	-	313 (305.4)	-7.6	18.3	-	+FL170	-	-	RNAV1

RWY16L

Serial Number	Path Descriptor	Waypoint Identifier	Fly Over	Course °M(T)	Magnetic Variation	Distance (NM)	Turn Direction	Altitude (FT)	Speed (KIAS)	Vertical Angle	Navigation Specification
001	VA	-	-	158 (150.0)	-7.6	-	-	+500	-	-	RNAV1
002	DF	T6L23	-	-	-7.6	-	L	-	-	-	RNAV1
003	TF	WELDA	-	055 (047.3)	-7.6	4.8	-	+6000	-	-	RNAV1
004	TF	PLUTO	-	352 (344.5)	-7.6	7.1	-	-	-	-	RNAV1
005	TF	KAIJI	-	011 (003.0)	-7.6	7.6	-	-	-	-	RNAV1
006	TF	INTEL	-	286 (278.4)	-7.6	11.9	-	+9000	-	-	RNAV1
007	TF	RAGOS	-	295 (287.2)	-7.6	13.0	-	+13000	-	-	RNAV1
008	TF	BEKLA	-	279 (271.2)	-7.6	14.8	-	+FL170	-	-	RNAV1

RWY34R

Serial Number	Path Descriptor	Waypoint Identifier	Fly Over	Course °M(T)	Magnetic Variation	Distance (NM)	Turn Direction	Altitude (FT)	Speed (KIAS)	Vertical Angle	Navigation Specification
001	VA	-	-	338 (330.0)	-7.6	-	-	+700	-	-	RNAV1
002	DF	ARAKA	-	-	-7.6	-	R	-	-	-	RNAV1
003	TF	EDOJO	-	018 (010.8)	-7.6	3.5	-	-	-	-	RNAV1
004	TF	OHEDO	-	331 (323.7)	-7.6	3.9	-	-	-	-	RNAV1
005	TF	INTEL	-	285 (277.0)	-7.6	4.1	-	+9000	-	-	RNAV1
006	TF	RAGOS	-	295 (287.2)	-7.6	13.0	-	+13000	-	-	RNAV1
007	TF	BEKLA	-	279 (271.2)	-7.6	14.8	-	+FL170	-	-	RNAV1

CHANGE : PROC renamed. Magnetic Variation. RWY16R:RTE after KAMAT.

STANDARD DEPARTURE CHART-INSTRUMENT

RJTT/TOKYO INTL

RNAV SID

RWY05

Serial Number	Path Descriptor	Waypoint Identifier	Fly Over	Course °M(°T)	Magnetic Variation	Distance (NM)	Turn Direction	Altitude (FT)	Speed (KIAS)	Vertical Angle	Navigation Specification
001	VA	-	-	050 (042.4)	-7.6	-	-	+500	-	-	RNAV1
002	DF	TT501	Y	-	-7.6	-	-	-	-	-	RNAV1
003	DF	TT502	-	-	-7.6	-	R	-	-	-	RNAV1
004	TF	LOCUP	-	199 (190.9)	-7.6	5.2	-	+5000	-	-	RNAV1
005	TF	TT503	-	288 (280.8)	-7.6	6.2	-	-	-	-	RNAV1
006	TF	KAMAT	-	322 (314.2)	-7.6	7.8	-	+9000	-	-	RNAV1
007	TF	LAYER	-	305 (297.1)	-7.6	12.2	-	+13000	-	-	RNAV1
008	TF	BEKLA	-	313 (305.4)	-7.6	18.3	-	+FL170	-	-	RNAV1

CHANGE : Magnetic Variation. RWY05:NR004(Course),RTE after KAMAT. Waypoint Coordinates(LAYER added).

Waypoint Coordinates

Waypoint Identifier	Coordinates	Waypoint Identifier	Coordinates
ARAKA	353848.8N / 1395041.9E	OHEDO	354523.4N / 1394838.6E
BEKLA	354958.7N / 1391009.5E	PLUTO	353632.1N / 1395736.8E
EDOJO	354214.0N / 1395129.9E	RAGOS	354942.2N / 1392821.2E
HATBA	352623.4N / 1394315.9E	T6L23	352627.6N / 1395539.1E
INTEL	354553.0N / 1394340.2E	T6R13	352800.8N / 1395006.4E
KAIJI	354409.6N / 1395806.6E	TT501	353328.7N / 1395029.9E
KAMAT	353353.6N / 1394148.9E	TT502	353224.4N / 1395720.7E
LAYER	353925.4N / 1392829.5E	TT503	352828.0N / 1394840.4E
LOCUP	352718.8N / 1395608.5E	WELDA	352941.4N / 1395956.7E

STANDARD DEPARTURE CHART-INSTRUMENT

RJTT/TOKYO INTL

RNAV SID

BEKLA TWO C DEPARTURE		RNAV1
Note 1) DME/DME/IRU or GNSS required. ※The aircraft equipped with only DME/DME/IRU must be able to update its position without delay at the starting point of take-off rolling. 2) RADAR service required.		RWY16R : HME 1.2NM FM DER - 1.9NM to T6R11 PQD 6.6NM to KAIJI - KAIJI NRE 6.9NM to INTEL - INTEL RWY16L : HME 1.0NM FM DER - 3.5NM to T6L23 PQD 6.6NM to KAIJI - KAIJI NRE 6.9NM to INTEL - INTEL RWY05 : HME DER - 2.7NM to TT502 TT503 - 3.8NM to KAMAT 1.8NM to KAMAT - KAMAT HYD 1.2NM to TT503 - TT503 4.8NM to KAMAT - 3.8NM to KAMAT
DME GAP	RWY16R : DER - 1.2NM FM DER RWY16L : DER - 1.0NM FM DER RWY34R : DER - 1.0NM FM DER RWY05 : 3.8NM to KAMAT - 1.8NM to KAMAT	
Inappropriate Nav aids	See AD1.1.6.10.3.Inappropriate NAVAIDs for RNAV1	

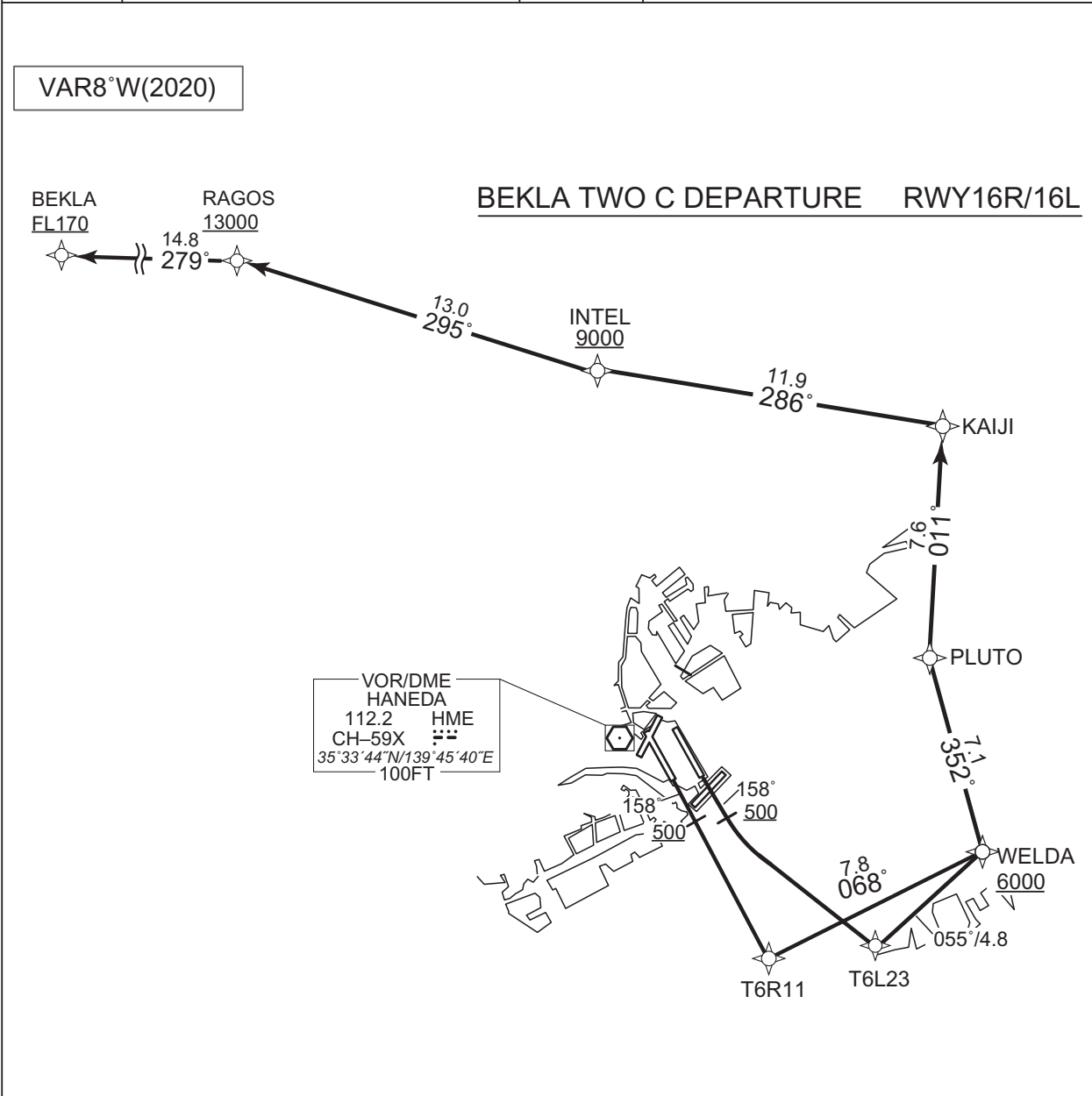

STANDARD DEPARTURE CHART-INSTRUMENT

RJTT/TOKYO INTL

RNAV SID

VAR8°W(2020)

BEKLA TWO C DEPARTURE RWY34R/05

CHANGE : PROC renamed. VAR. RTE after KAMAT. Course FM TT502 to LOCUP.

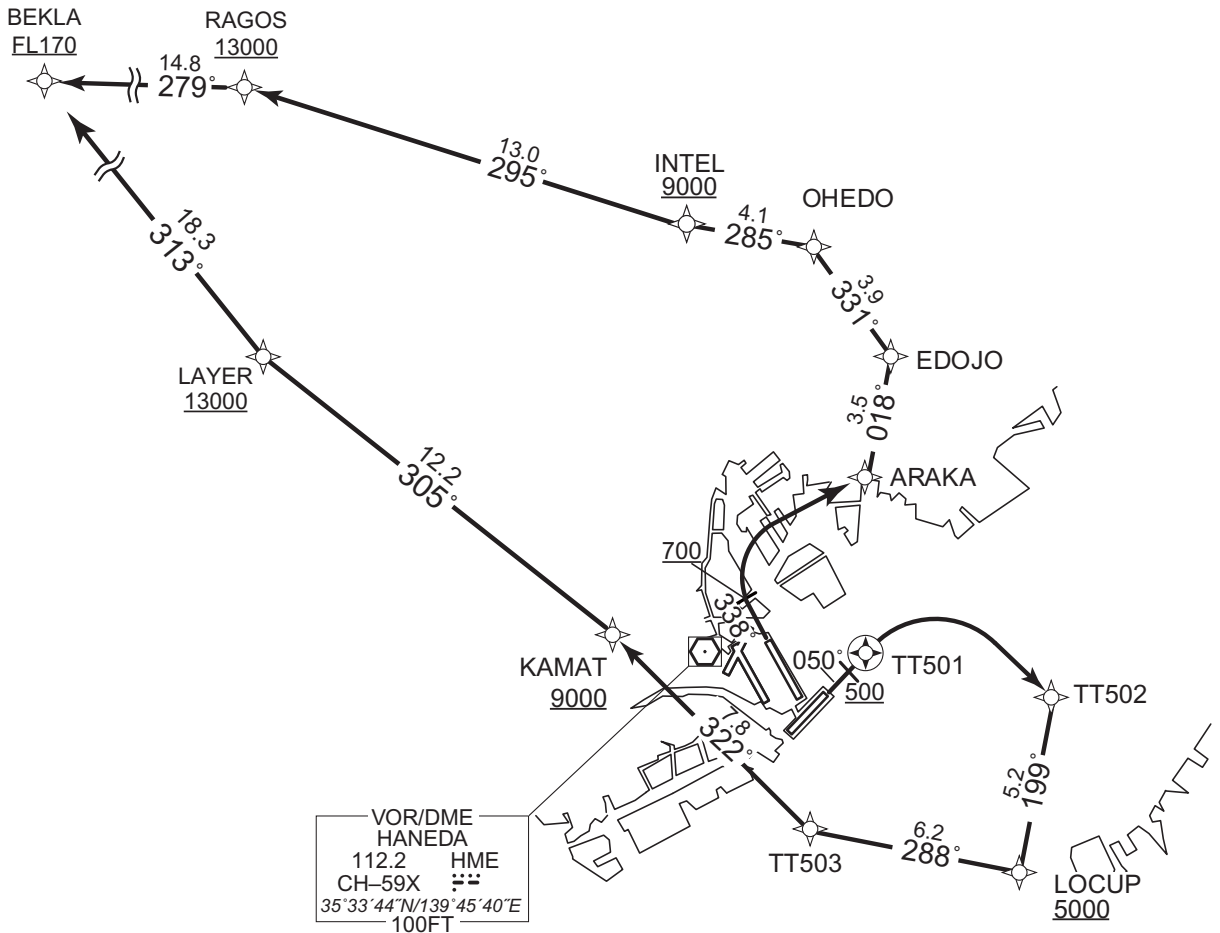



## STANDARD DEPARTURE CHART-INSTRUMENT

RJTT/TOKYO INTL

RNAV SID

BEKLA TWO C DEPARTURE

RWY16R : Climb on HDG 158° at or above 500FT, direct to T6R11,  
to WELDA at or above 6000FT, to PLUTO, to KAIJI, to INTEL  
at or above 9000FT, to RAGOS at or above 13000FT,  
to BEKLA at or above FL170.

RWY16L : Climb on HDG 158° at or above 500FT, turn left direct to T6L23,  
to WELDA at or above 6000FT, to PLUTO, to KAIJI, to INTEL  
at or above 9000FT, to RAGOS at or above 13000FT,  
to BEKLA at or above FL170.

RWY34R : Climb on HDG 338° at or above 700FT, turn right direct to ARAKA,  
to EDOJO, to OHEDO, to INTEL at or above 9000FT, to RAGOS  
at or above 13000FT, to BEKLA at or above FL170.

RWY05 : Climb on HDG 050° at or above 500FT, direct to TT501, turn right  
direct to TT502, to LOCUP at or above 5000FT, to TT503, to  
KAMAT at or above 9000FT, to LAYER at or above 13000FT, to  
BEKLA at or above FL170.

Note RWY34R : 5.0% climb gradient required up to 700FT.  
RWY05 : 5.0% climb gradient required up to 500FT.

CHANGE : PROC renamed. RTE after KAMAT(RWY05).

STANDARD DEPARTURE CHART-INSTRUMENT

RJTT/TOKYO INTL

RNAV SID

BEKLA TWO C DEPARTURE

RWY16R

Serial Number	Path Descriptor	Waypoint Identifier	Fly Over	Course °M(°T)	Magnetic Variation	Distance (NM)	Turn Direction	Altitude (FT)	Speed (KIAS)	Vertical Angle	Navigation Specification
001	VA	-	-	158 (150.0)	-7.6	-	-	+500	-	-	RNAV1
002	DF	T6R11	-	-	-7.6	-	-	-	-	-	RNAV1
003	TF	WELDA	-	068 (060.6)	-7.6	7.8	-	+6000	-	-	RNAV1
004	TF	PLUTO	-	352 (344.5)	-7.6	7.1	-	-	-	-	RNAV1
005	TF	KAIJI	-	011 (003.0)	-7.6	7.6	-	-	-	-	RNAV1
006	TF	INTEL	-	286 (278.4)	-7.6	11.9	-	+9000	-	-	RNAV1
007	TF	RAGOS	-	295 (287.2)	-7.6	13.0	-	+13000	-	-	RNAV1
008	TF	BEKLA	-	279 (271.2)	-7.6	14.8	-	+FL170	-	-	RNAV1

RWY16L

Serial Number	Path Descriptor	Waypoint Identifier	Fly Over	Course °M(°T)	Magnetic Variation	Distance (NM)	Turn Direction	Altitude (FT)	Speed (KIAS)	Vertical Angle	Navigation Specification
001	VA	-	-	158 (150.0)	-7.6	-	-	+500	-	-	RNAV1
002	DF	T6L23	-	-	-7.6	-	L	-	-	-	RNAV1
003	TF	WELDA	-	055 (047.3)	-7.6	4.8	-	+6000	-	-	RNAV1
004	TF	PLUTO	-	352 (344.5)	-7.6	7.1	-	-	-	-	RNAV1
005	TF	KAIJI	-	011 (003.0)	-7.6	7.6	-	-	-	-	RNAV1
006	TF	INTEL	-	286 (278.4)	-7.6	11.9	-	+9000	-	-	RNAV1
007	TF	RAGOS	-	295 (287.2)	-7.6	13.0	-	+13000	-	-	RNAV1
008	TF	BEKLA	-	279 (271.2)	-7.6	14.8	-	+FL170	-	-	RNAV1

RWY34R

Serial Number	Path Descriptor	Waypoint Identifier	Fly Over	Course °M(°T)	Magnetic Variation	Distance (NM)	Turn Direction	Altitude (FT)	Speed (KIAS)	Vertical Angle	Navigation Specification
001	VA	-	-	338 (330.0)	-7.6	-	-	+700	-	-	RNAV1
002	DF	ARAKA	-	-	-7.6	-	R	-	-	-	RNAV1
003	TF	EDOJO	-	018 (010.8)	-7.6	3.5	-	-	-	-	RNAV1
004	TF	OHEDO	-	331 (323.7)	-7.6	3.9	-	-	-	-	RNAV1
005	TF	INTEL	-	285 (277.0)	-7.6	4.1	-	+9000	-	-	RNAV1
006	TF	RAGOS	-	295 (287.2)	-7.6	13.0	-	+13000	-	-	RNAV1
007	TF	BEKLA	-	279 (271.2)	-7.6	14.8	-	+FL170	-	-	RNAV1

CHANGE : PROC renamed. Magnetic Variation.

STANDARD DEPARTURE CHART-INSTRUMENT

RJTT/TOKYO INTL

RNAV SID

RWY05

Serial Number	Path Descriptor	Waypoint Identifier	Fly Over	Course °M(°T)	Magnetic Variation	Distance (NM)	Turn Direction	Altitude (FT)	Speed (KIAS)	Vertical Angle	Navigation Specification
001	VA	-	-	050 (042.4)	-7.6	-	-	+500	-	-	RNAV1
002	DF	TT501	Y	-	-7.6	-	-	-	-	-	RNAV1
003	DF	TT502	-	-	-7.6	-	R	-	-	-	RNAV1
004	TF	LOCUP	-	199 (190.9)	-7.6	5.2	-	+5000	-	-	RNAV1
005	TF	TT503	-	288 (280.8)	-7.6	6.2	-	-	-	-	RNAV1
006	TF	KAMAT	-	322 (314.2)	-7.6	7.8	-	+9000	-	-	RNAV1
007	TF	LAYER	-	305 (297.1)	-7.6	12.2	-	+13000	-	-	RNAV1
008	TF	BEKLA	-	313 (305.4)	-7.6	18.3	-	+FL170	-	-	RNAV1

CHANGE : Magnetic Variation. RWY05:NR004(Course),RTE after KAMAT. Waypoint Coordinates(LAYER added).

Waypoint Coordinates

Waypoint Identifier	Coordinates	Waypoint Identifier	Coordinates
ARAKA	353848.8N / 1395041.9E	PLUTO	353632.1N / 1395736.8E
BEKLA	354958.7N / 1391009.5E	RAGOS	354942.2N / 1392821.2E
EDOJO	354214.0N / 1395129.9E	T6L23	352627.6N / 1395539.1E
INTEL	354553.0N / 1394340.2E	T6R11	352552.5N / 1395137.2E
KAIJI	354409.6N / 1395806.6E	TT501	353328.7N / 1395029.9E
KAMAT	353353.6N / 1394148.9E	TT502	353224.4N / 1395720.7E
LAYER	353925.4N / 1392829.5E	TT503	352828.0N / 1394840.4E
LOCUP	352718.8N / 1395608.5E	WELDA	352941.4N / 1395956.7E
OHEDO	354523.4N / 1394838.6E		

STANDARD DEPARTURE CHART-INSTRUMENT

RJTT/TOKYO INTL

RNAV SID

ROVER TWO A DEPARTURE		RNAV1
Note 1) DME/DME/IRU or GNSS required. ※The aircraft equipped with only DME/DME/IRU must be able to update its position without delay at the starting point of take-off rolling. 2) RADAR service required.		RWY16R : HME 1.2NM FM DER - 1.9NM to T6R11 PQD 6.6NM to KAIJI - KAIJI RWY16L : HME 1.0NM FM DER - 3.5NM to T6L23 PQD 6.6NM to KAIJI - KAIJI RWY34R : HME 1.0NM FM DER - 1.1NM to PLUTO SND TORAM - 3.1NM to PLUTO PQD 6.6NM to KAIJI - KAIJI RWY34L : HME 0.5NM FM DER - 1.1NM to PLUTO SND TORAM - 3.1NM to PLUTO PQD 6.6NM to KAIJI - KAIJI RWY04 : HME 1.7NM FM DER - 1.1NM to PLUTO SND 2.2NM to TORAM - 3.1NM to PLUTO PQD 6.6NM to KAIJI - KAIJI RWY05 : HME DER - 2.2NM to PLUTO PQD 6.6NM to KAIJI - KAIJI
DME GAP	RWY16R : DER - 1.2NM FM DER RWY16L : DER - 1.0NM FM DER RWY34R : DER - 1.0NM FM DER RWY34L : DER - 0.5NM FM DER RWY04 : DER - 1.7NM FM DER	Critical DME
Inappropriate Nav aids	See AD1.1.6.10.3.Inappropriate NAVAIDs for RNAV1	

VAR8°W(2020)

ROVER TWO A DEPARTURE

CHANGE : PROC renamed. VAR. HDG after DEP FM RWY04.

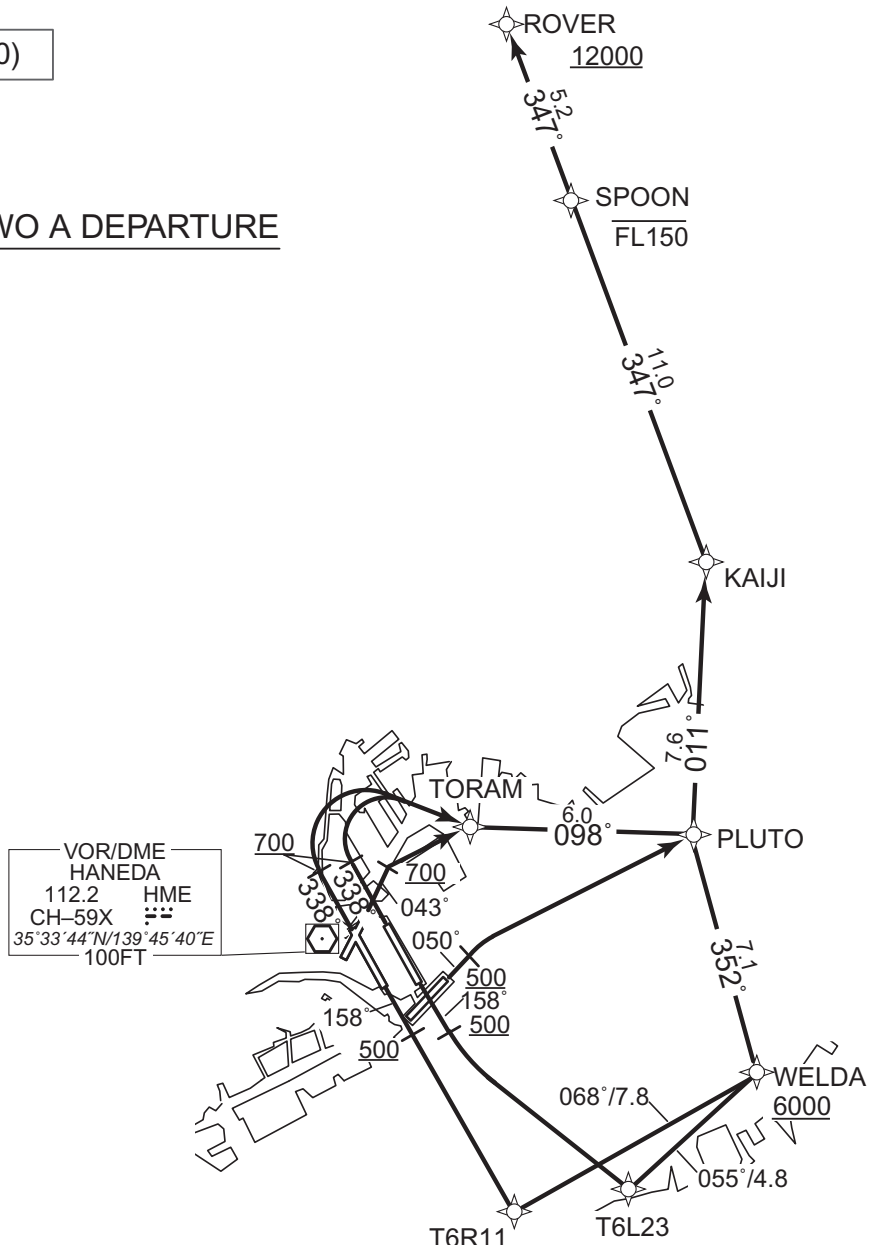

## STANDARD DEPARTURE CHART-INSTRUMENT

RJTT/TOKYO INTL

RNAV SID

ROVER TWO A DEPARTURE

RWY16R : Climb on HDG 158° at or above 500FT, direct to T6R11,  
to WELDA at or above 6000FT, to PLUTO, to KAIJI,  
to SPOON at or below FL150, to ROVER at or above 12000FT.

RWY16L : Climb on HDG 158° at or above 500FT, turn left direct to T6L23,  
to WELDA at or above 6000FT, to PLUTO, to KAIJI,  
to SPOON at or below FL150, to ROVER at or above 12000FT.

RWY34L/34R : Climb on HDG 338° at or above 700FT, turn right direct to  
TORAM, to PLUTO, to KAIJI, to SPOON at or below FL150,  
to ROVER at or above 12000FT.

RWY04 : Climb on HDG 043° at or above 700FT, direct to TORAM, to PLUTO,  
to KAIJI, to SPOON at or below FL150, to ROVER at or above  
12000FT.

RWY05 : Climb on HDG 050° at or above 500FT, turn right direct to PLUTO,  
to KAIJI, to SPOON at or below FL150, to ROVER at or above  
12000FT.

Note RWY34L/34R/04 : 5.0% climb gradient required up to 700FT.  
RWY05 : 5.0% climb gradient required up to 500FT.

CHANGE : PROC renamed. HDG after DEP FM RWY04.

STANDARD DEPARTURE CHART-INSTRUMENT

RJTT/TOKYO INTL

RNAV SID

ROVER TWO A DEPARTURE

RWY16R

Serial Number	Path Descriptor	Waypoint Identifier	Fly Over	Course °M(°T)	Magnetic Variation	Distance (NM)	Turn Direction	Altitude (FT)	Speed (KIAS)	Vertical Angle	Navigation Specification
001	VA	-	-	158 (150.0)	-7.6	-	-	+500	-	-	RNAV1
002	DF	T6R11	-	-	-7.6	-	-	-	-	-	RNAV1
003	TF	WELDA	-	068 (060.6)	-7.6	7.8	-	+6000	-	-	RNAV1
004	TF	PLUTO	-	352 (344.5)	-7.6	7.1	-	-	-	-	RNAV1
005	TF	KAIJI	-	011 (003.0)	-7.6	7.6	-	-	-	-	RNAV1
006	TF	SPOON	-	347 (339.2)	-7.6	11.0	-	-FL150	-	-	RNAV1
007	TF	ROVER	-	347 (339.1)	-7.6	5.2	-	+12000	-	-	RNAV1

RWY16L

Serial Number	Path Descriptor	Waypoint Identifier	Fly Over	Course °M(°T)	Magnetic Variation	Distance (NM)	Turn Direction	Altitude (FT)	Speed (KIAS)	Vertical Angle	Navigation Specification
001	VA	-	-	158 (150.0)	-7.6	-	-	+500	-	-	RNAV1
002	DF	T6L23	-	-	-7.6	-	L	-	-	-	RNAV1
003	TF	WELDA	-	055 (047.3)	-7.6	4.8	-	+6000	-	-	RNAV1
004	TF	PLUTO	-	352 (344.5)	-7.6	7.1	-	-	-	-	RNAV1
005	TF	KAIJI	-	011 (003.0)	-7.6	7.6	-	-	-	-	RNAV1
006	TF	SPOON	-	347 (339.2)	-7.6	11.0	-	-FL150	-	-	RNAV1
007	TF	ROVER	-	347 (339.1)	-7.6	5.2	-	+12000	-	-	RNAV1

RWY34L/RWY34R

Serial Number	Path Descriptor	Waypoint Identifier	Fly Over	Course °M(°T)	Magnetic Variation	Distance (NM)	Turn Direction	Altitude (FT)	Speed (KIAS)	Vertical Angle	Navigation Specification
001	VA	-	-	338 (330.0)	-7.6	-	-	+700	-	-	RNAV1
002	DF	TORAM	-	-	-7.6	-	R	-	-	-	RNAV1
003	TF	PLUTO	-	098 (090.7)	-7.6	6.0	-	-	-	-	RNAV1
004	TF	KAIJI	-	011 (003.0)	-7.6	7.6	-	-	-	-	RNAV1
005	TF	SPOON	-	347 (339.2)	-7.6	11.0	-	-FL150	-	-	RNAV1
006	TF	ROVER	-	347 (339.1)	-7.6	5.2	-	+12000	-	-	RNAV1

CHANGE : PROC renamed. Magnetic Variation.

## STANDARD DEPARTURE CHART-INSTRUMENT

RJTT/TOKYO INTL

RNAV SID

## RWY04

Serial Number	Path Descriptor	Waypoint Identifier	Fly Over	Course °M(°T)	Magnetic Variation	Distance (NM)	Turn Direction	Altitude (FT)	Speed (KIAS)	Vertical Angle	Navigation Specification
001	VA	-	-	043 (034.9)	-7.6	-	-	+700	-	-	RNAV1
002	DF	TORAM	-	-	-7.6	-	-	-	-	-	RNAV1
003	TF	PLUTO	-	098 (090.7)	-7.6	6.0	-	-	-	-	RNAV1
004	TF	KAIJI	-	011 (003.0)	-7.6	7.6	-	-	-	-	RNAV1
005	TF	SPOON	-	347 (339.2)	-7.6	11.0	-	-FL150	-	-	RNAV1
006	TF	ROVER	-	347 (339.1)	-7.6	5.2	-	+12000	-	-	RNAV1

## RWY05

Serial Number	Path Descriptor	Waypoint Identifier	Fly Over	Course °M(°T)	Magnetic Variation	Distance (NM)	Turn Direction	Altitude (FT)	Speed (KIAS)	Vertical Angle	Navigation Specification
001	VA	-	-	050 (042.4)	-7.6	-	-	+500	-	-	RNAV1
002	DF	PLUTO	-	-	-7.6	-	R	-	-	-	RNAV1
003	TF	KAIJI	-	011 (003.0)	-7.6	7.6	-	-	-	-	RNAV1
004	TF	SPOON	-	347 (339.2)	-7.6	11.0	-	-FL150	-	-	RNAV1
005	TF	ROVER	-	347 (339.1)	-7.6	5.2	-	+12000	-	-	RNAV1

Waypoint Coordinates

Waypoint Identifier	Coordinates	Waypoint Identifier	Coordinates
KAIJI	354409.6N / 1395806.6E	T6L23	352627.6N / 1395539.1E
PLUTO	353632.1N / 1395736.8E	T6R11	352552.5N / 1395137.2E
ROVER	355918.3N / 1395059.3E	TORAM	353636.8N / 1395011.0E
SPOON	355428.3N / 1395316.0E	WELDA	352941.4N / 1395956.7E

CHANGE : Magnetic Variation. RWY04:NR001(Course).

STANDARD DEPARTURE CHART-INSTRUMENT

RJTT/TOKYO INTL

RNAV SID

ROVER TWO B DEPARTURE

RNAV1

Note 1) DME/DME/IRU or GNSS required.  
 ※The aircraft equipped with only DME/DME/IRU must be able to update its position without delay at the starting point of take-off rolling.  
 2) RADAR service required.

DME GAP  
 RWY16R : DER - 1.2NM FM DER  
 RWY16L : DER - 1.0NM FM DER  
 RWY34R : DER - 1.0NM FM DER

Critical DME

RWY16R : HME 1.2NM FM DER - 1.9NM to T6R11  
 PQD 6.6NM to KAIJI - KAIJI  
 RWY16L : HME 1.0NM FM DER - 3.5NM to T6L23  
 PQD 6.6NM to KAIJI - KAIJI  
 RWY05 : HME DER - 2.2NM to PLUTO  
 PQD 6.6NM to KAIJI - KAIJI

Inappropriate Nav aids  
 See AD1.1.6.10.3.Inappropriate NAVAIDs for RNAV1

VAR8°W(2020)

ROVER TWO B DEPARTURE

CHANGE : PROC renamed.

VOR/DME  
 HANEDA  
 112.2 HME  
 CH-59X  
 35°33'44"N/139°45'40"E  
 100FT

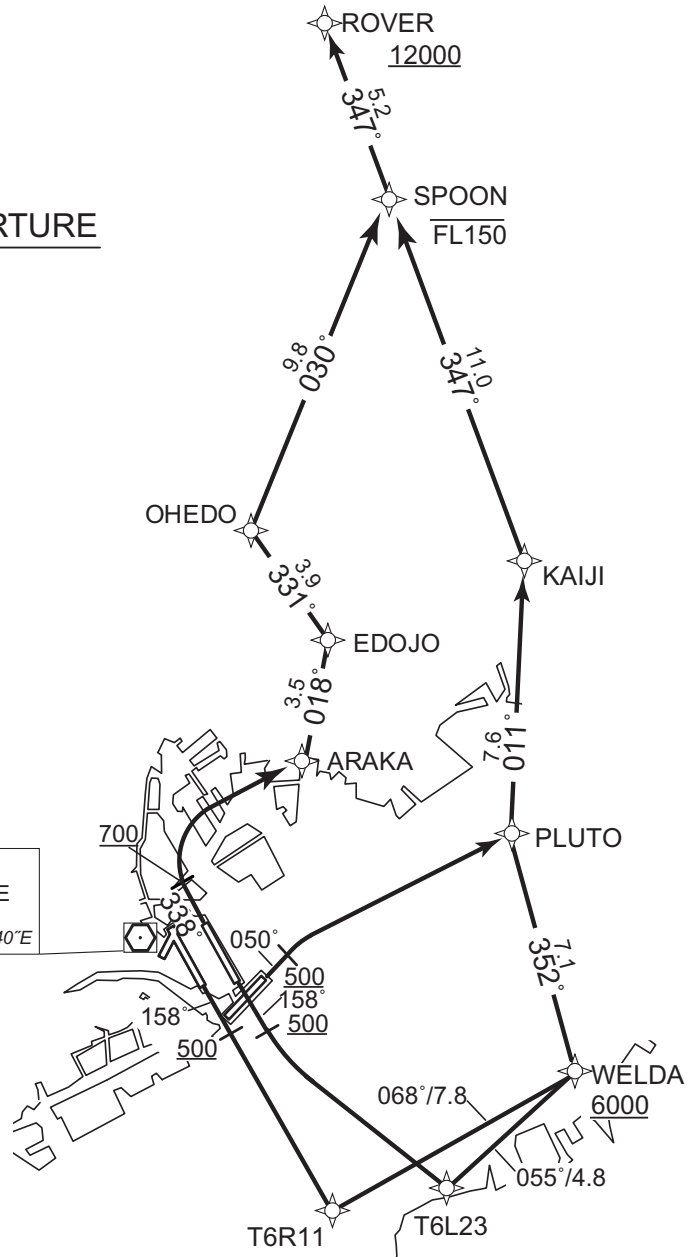



## STANDARD DEPARTURE CHART-INSTRUMENT

RJTT/TOKYO INTL

RNAV SID

ROVER TWO B DEPARTURE

RWY16R : Climb on HDG 158° at or above 500FT, direct to T6R11,  
to WELDA at or above 6000FT, to PLUTO, to KAIJI,  
to SPOON at or below FL150, to ROVER at or above 12000FT.

RWY16L : Climb on HDG 158° at or above 500FT, turn left direct to T6L23,  
to WELDA at or above 6000FT, to PLUTO, to KAIJI,  
to SPOON at or below FL150, to ROVER at or above 12000FT.

RWY34R : Climb on HDG 338° at or above 700FT, turn right direct to ARAKA,  
to EDOJO, to OHEDO, to SPOON at or below FL150, to ROVER  
at or above 12000FT.

RWY05 : Climb on HDG 050° at or above 500FT, turn right direct to PLUTO,  
to KAIJI, to SPOON at or below FL150, to ROVER at or above  
12000FT.

Note RWY34R : 5.0% climb gradient required up to 700FT.  
RWY05 : 5.0% climb gradient required up to 500FT.

CHANGE : PROC renamed.

STANDARD DEPARTURE CHART-INSTRUMENT

RJTT/TOKYO INTL

RNAV SID

ROVER TWO B DEPARTURE

RWY16R

Serial Number	Path Descriptor	Waypoint Identifier	Fly Over	Course °M(°T)	Magnetic Variation	Distance (NM)	Turn Direction	Altitude (FT)	Speed (KIAS)	Vertical Angle	Navigation Specification
001	VA	-	-	158 (150.0)	-7.6	-	-	+500	-	-	RNAV1
002	DF	T6R11	-	-	-7.6	-	-	-	-	-	RNAV1
003	TF	WELDA	-	068 (060.6)	-7.6	7.8	-	+6000	-	-	RNAV1
004	TF	PLUTO	-	352 (344.5)	-7.6	7.1	-	-	-	-	RNAV1
005	TF	KAIJI	-	011 (003.0)	-7.6	7.6	-	-	-	-	RNAV1
006	TF	SPOON	-	347 (339.2)	-7.6	11.0	-	-FL150	-	-	RNAV1
007	TF	ROVER	-	347 (339.1)	-7.6	5.2	-	+12000	-	-	RNAV1

RWY16L

Serial Number	Path Descriptor	Waypoint Identifier	Fly Over	Course °M(°T)	Magnetic Variation	Distance (NM)	Turn Direction	Altitude (FT)	Speed (KIAS)	Vertical Angle	Navigation Specification
001	VA	-	-	158 (150.0)	-7.6	-	-	+500	-	-	RNAV1
002	DF	T6L23	-	-	-7.6	-	L	-	-	-	RNAV1
003	TF	WELDA	-	055 (047.3)	-7.6	4.8	-	+6000	-	-	RNAV1
004	TF	PLUTO	-	352 (344.5)	-7.6	7.1	-	-	-	-	RNAV1
005	TF	KAIJI	-	011 (003.0)	-7.6	7.6	-	-	-	-	RNAV1
006	TF	SPOON	-	347 (339.2)	-7.6	11.0	-	-FL150	-	-	RNAV1
007	TF	ROVER	-	347 (339.1)	-7.6	5.2	-	+12000	-	-	RNAV1

RWY34R

Serial Number	Path Descriptor	Waypoint Identifier	Fly Over	Course °M(°T)	Magnetic Variation	Distance (NM)	Turn Direction	Altitude (FT)	Speed (KIAS)	Vertical Angle	Navigation Specification
001	VA	-	-	338 (330.0)	-7.6	-	-	+700	-	-	RNAV1
002	DF	ARAKA	-	-	-7.6	-	R	-	-	-	RNAV1
003	TF	EDOJO	-	018 (010.8)	-7.6	3.5	-	-	-	-	RNAV1
004	TF	OHEDO	-	331 (323.7)	-7.6	3.9	-	-	-	-	RNAV1
005	TF	SPOON	-	030 (022.4)	-7.6	9.8	-	-FL150	-	-	RNAV1
006	TF	ROVER	-	347 (339.1)	-7.6	5.2	-	+12000	-	-	RNAV1

CHANGE : PROC renamed.

STANDARD DEPARTURE CHART-INSTRUMENT

RJTT/TOKYO INTL

RNAV SID

RWY05

Serial Number	Path Descriptor	Waypoint Identifier	Fly Over	Course °M(^T)	Magnetic Variation	Distance (NM)	Turn Direction	Altitude (FT)	Speed (KIAS)	Vertical Angle	Navigation Specification
001	VA	-	-	050 (042.4)	-7.6	-	-	+500	-	-	RNAV1
002	DF	PLUTO	-	-	-7.6	-	R	-	-	-	RNAV1
003	TF	KAIJI	-	011 (003.0)	-7.6	7.6	-	-	-	-	RNAV1
004	TF	SPOON	-	347 (339.2)	-7.6	11.0	-	-FL150	-	-	RNAV1
005	TF	ROVER	-	347 (339.1)	-7.6	5.2	-	+12000	-	-	RNAV1

Waypoint Coordinates

Waypoint Identifier	Coordinates	Waypoint Identifier	Coordinates
ARAKA	353848.8N / 1395041.9E	ROVER	355918.3N / 1395059.3E
EDOJO	354214.0N / 1395129.9E	SPOON	355428.3N / 1395316.0E
KAIJI	354409.6N / 1395806.6E	T6L23	352627.6N / 1395539.1E
OHEDO	354523.4N / 1394838.6E	T6R11	352552.5N / 1395137.2E
PLUTO	353632.1N / 1395736.8E	WELDA	352941.4N / 1395956.7E

CHANGE : Magnetic Variation.

STANDARD DEPARTURE CHART-INSTRUMENT

RJTT/TOKYO INTL

RNAV SID

ROVER TWO C DEPARTURE		RNAV SID
Note 1) DME/DME/IRU or GNSS required. ※ The aircraft equipped with only DME/DME/IRU must be able to update its position without delay at the starting point of take-off rolling. 2) RADAR service required.		RWY16R : HME 1.2NM FM DER - 1.9NM to T6R11 PQD 6.6NM to KAIJI - KAIJI  RWY05 : HME DER - 2.2NM to PLUTO PQD 6.6NM to KAIJI - KAIJI
DME GAP	RWY16R : DER - 1.2NM FM DER RWY16L : DER - 1.0NM FM DER RWY34R : DER - 1.0NM FM DER	
Inappropriate Nav aids	See AD1.1.6.10.3. Inappropriate NAVAIDs for RNAV1	

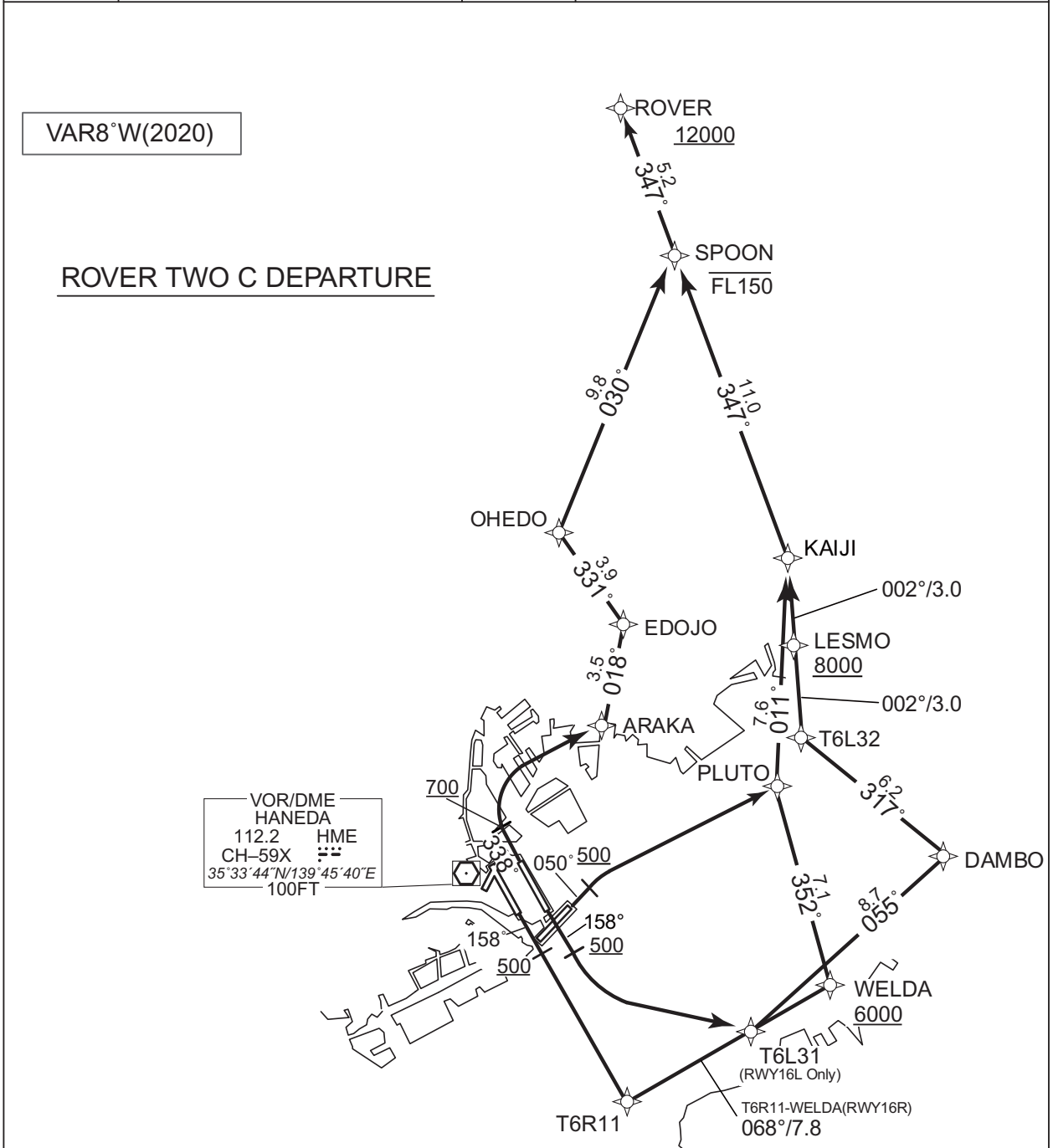

CHANGE : PROC renamed.

## STANDARD DEPARTURE CHART-INSTRUMENT

RJTT/TOKYO INTL

RNAV SID

ROVER TWO C DEPARTURE

RWY16R : Climb on HDG 158° at or above 500FT, direct to T6R11,  
to WELDA at or above 6000FT, to PLUTO, to KAIJI,  
to SPOON at or below FL150, to ROVER at or above 12000FT.

RWY16L : Climb on HDG 158° at or above 500FT, turn left direct to T6L31,  
to DAMBO, to T6L32, to LESMO at or above 8000FT, to KAIJI,  
to SPOON at or below FL150, to ROVER at or above 12000FT.

RWY34R : Climb on HDG 338° at or above 700FT, turn right direct to ARAKA,  
to EDOJO, to OHEDO, to SPOON at or below FL150, to ROVER  
at or above 12000FT.

RWY05 : Climb on HDG 050° at or above 500FT, turn right direct to PLUTO,  
to KAIJI, to SPOON at or below FL150, to ROVER at or above  
12000FT.

Note RWY34R : 5.0% climb gradient required up to 700FT.  
RWY05 : 5.0% climb gradient required up to 500FT.

CHANGE : PROC renamed.

STANDARD DEPARTURE CHART-INSTRUMENT

RJTT/TOKYO INTL

RNAV SID

ROVER TWO C DEPARTURE

RWY16R

Serial Number	Path Descriptor	Waypoint Identifier	Fly Over	Course °M(°T)	Magnetic Variation	Distance (NM)	Turn Direction	Altitude (FT)	Speed (KIAS)	Vertical Angle	Navigation Specification
001	VA	-	-	158 (150.0)	-7.6	-	-	+500	-	-	RNAV1
002	DF	T6R11	-	-	-7.6	-	-	-	-	-	RNAV1
003	TF	WELDA	-	068 (060.6)	-7.6	7.8	-	+6000	-	-	RNAV1
004	TF	PLUTO	-	352 (344.5)	-7.6	7.1	-	-	-	-	RNAV1
005	TF	KAIJI	-	011 (003.0)	-7.6	7.6	-	-	-	-	RNAV1
006	TF	SPOON	-	347 (339.2)	-7.6	11.0	-	-FL150	-	-	RNAV1
007	TF	ROVER	-	347 (339.1)	-7.6	5.2	-	+12000	-	-	RNAV1

RWY16L

Serial Number	Path Descriptor	Waypoint Identifier	Fly Over	Course °M(°T)	Magnetic Variation	Distance (NM)	Turn Direction	Altitude (FT)	Speed (KIAS)	Vertical Angle	Navigation Specification
001	VA	-	-	158 (150.0)	-7.6	-	-	+500	-	-	RNAV1
002	DF	T6L31	-	-	-7.6	-	L	-	-	-	RNAV1
003	TF	DAMBO	-	055 (047.5)	-7.6	8.7	-	-	-	-	RNAV1
004	TF	T6L32	-	317 (309.4)	-7.6	6.2	-	-	-	-	RNAV1
005	TF	LESMO	-	002 (354.1)	-7.6	3.0	-	+8000	-	-	RNAV1
006	TF	KAIJI	-	002 (354.1)	-7.6	3.0	-	-	-	-	RNAV1
007	TF	SPOON	-	347 (339.2)	-7.6	11.0	-	-FL150	-	-	RNAV1
008	TF	ROVER	-	347 (339.1)	-7.6	5.2	-	+12000	-	-	RNAV1

RWY34R

Serial Number	Path Descriptor	Waypoint Identifier	Fly Over	Course °M(°T)	Magnetic Variation	Distance (NM)	Turn Direction	Altitude (FT)	Speed (KIAS)	Vertical Angle	Navigation Specification
001	VA	-	-	338 (330.0)	-7.6	-	-	+700	-	-	RNAV1
002	DF	ARAKA	-	-	-7.6	-	R	-	-	-	RNAV1
003	TF	EDOJO	-	018 (010.8)	-7.6	3.5	-	-	-	-	RNAV1
004	TF	OHEDO	-	331 (323.7)	-7.6	3.9	-	-	-	-	RNAV1
005	TF	SPOON	-	030 (022.4)	-7.6	9.8	-	-FL150	-	-	RNAV1
006	TF	ROVER	-	347 (339.1)	-7.6	5.2	-	+12000	-	-	RNAV1

CHANGE : PROC renamed.

STANDARD DEPARTURE CHART-INSTRUMENT

RJTT/TOKYO INTL

RNAV SID

RWY05

Serial Number	Path Descriptor	Waypoint Identifier	Fly Over	Course °M(^T)	Magnetic Variation	Distance (NM)	Turn Direction	Altitude (FT)	Speed (KIAS)	Vertical Angle	Navigation Specification
001	VA	-	-	050 (042.4)	-7.6	-	-	+500	-	-	RNAV1
002	DF	PLUTO	-	-	-7.6	-	R	-	-	-	RNAV1
003	TF	KAIJI	-	011 (003.0)	-7.6	7.6	-	-	-	-	RNAV1
004	TF	SPOON	-	347 (339.2)	-7.6	11.0	-	-FL150	-	-	RNAV1
005	TF	ROVER	-	347 (339.1)	-7.6	5.2	-	+12000	-	-	RNAV1

Waypoint Coordinates

Waypoint Identifier	Coordinates	Waypoint Identifier	Coordinates
ARAKA	353848.8N / 1395041.9E	ROVER	355918.3N / 1395059.3E
DAMBO	353416.5N / 1400443.4E	SPOON	355428.3N / 1395316.0E
EDOJO	354214.0N / 1395129.9E	T6L31	352822.8N / 1395648.0E
KAIJI	354409.6N / 1395806.6E	T6L32	353810.9N / 1395852.2E
LESMO	354110.3N / 1395829.4E	T6R11	352552.5N / 1395137.2E
OHEDO	354523.4N / 1394838.6E	WELDA	352941.4N / 1395956.7E
PLUTO	353632.1N / 1395736.8E		

CHANGE : Magnetic Variation.

STANDARD DEPARTURE CHART-INSTRUMENT

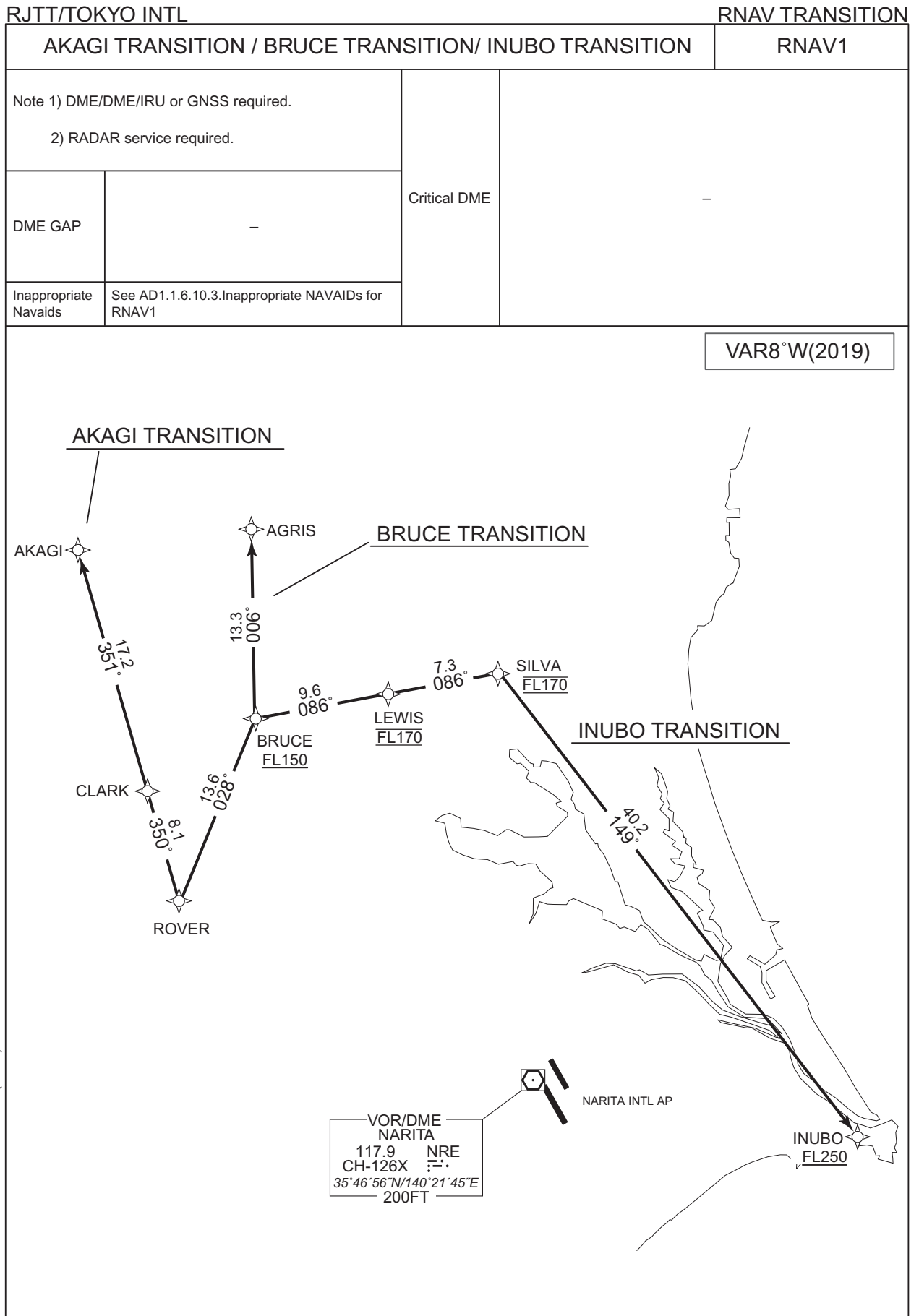



STANDARD DEPARTURE CHART-INSTRUMENT

RJTT/TOKYO INTL

RNAV TRANSITION

AKAGI TRANSITION

From ROVER, to CLARK, to AKAGI.

Serial Number	Path Descriptor	Waypoint Identifier	Fly Over	Course °M(°T)	Magnetic Variation	Distance (NM)	Turn Direction	Altitude (FT)	Speed (KIAS)	Vertical Angle	Navigation Specification
001	IF	ROVER	-	-	-7.5	-	-	-	-	-	RNAV1
002	TF	CLARK	-	350 (342.7)	-7.5	8.1	-	-	-	-	RNAV1
003	TF	AKAGI	-	351 (343.4)	-7.5	17.2	-	-	-	-	RNAV1

BRUCE TRANSITION

From ROVER, to BRUCE at or above FL150, to AGRIS.

Serial Number	Path Descriptor	Waypoint Identifier	Fly Over	Course °M(°T)	Magnetic Variation	Distance (NM)	Turn Direction	Altitude (FT)	Speed (KIAS)	Vertical Angle	Navigation Specification
001	IF	ROVER	-	-	-7.5	-	-	-	-	-	RNAV1
002	TF	BRUCE	-	028 (020.7)	-7.5	13.6	-	+FL150	-	-	RNAV1
003	TF	AGRIS	-	006 (358.7)	-7.5	13.3	-	-	-	-	RNAV1

INUBO TRANSITION

From ROVER, to BRUCE at or above FL150, to LEWIS at FL170, to SILVA at FL170, to INUBO at or above FL250.

Serial Number	Path Descriptor	Waypoint Identifier	Fly Over	Course °M(°T)	Magnetic Variation	Distance (NM)	Turn Direction	Altitude (FT)	Speed (KIAS)	Vertical Angle	Navigation Specification
001	IF	ROVER	-	-	-7.5	-	-	-	-	-	RNAV1
002	TF	BRUCE	-	028 (020.7)	-7.5	13.6	-	+FL150	-	-	RNAV1
003	TF	LEWIS	-	086 (078.6)	-7.5	9.6	-	FL170	-	-	RNAV1
004	TF	SILVA	-	086 (078.8)	-7.5	7.3	-	FL170	-	-	RNAV1
005	TF	INUBO	-	149 (141.9)	-7.5	40.2	-	+FL250	-	-	RNAV1

Waypoint Coordinates

Waypoint Identifier	Coordinates	Waypoint Identifier	Coordinates
AGRIS	362514.7N / 1395633.1E	INUBO	354335.3N / 1404757.9E
AKAGI	362328.3N / 1394156.3E	LEWIS	361353.2N / 1400834.7E
BRUCE	361200.4N / 1395655.9E	ROVER	355918.3N / 1395059.3E
CLARK	360702.0N / 1394800.5E	SILVA	361518.0N / 1401726.0E

CHANGE : ALT Restriction on BRUCE

STANDARD DEPARTURE CHART-INSTRUMENT

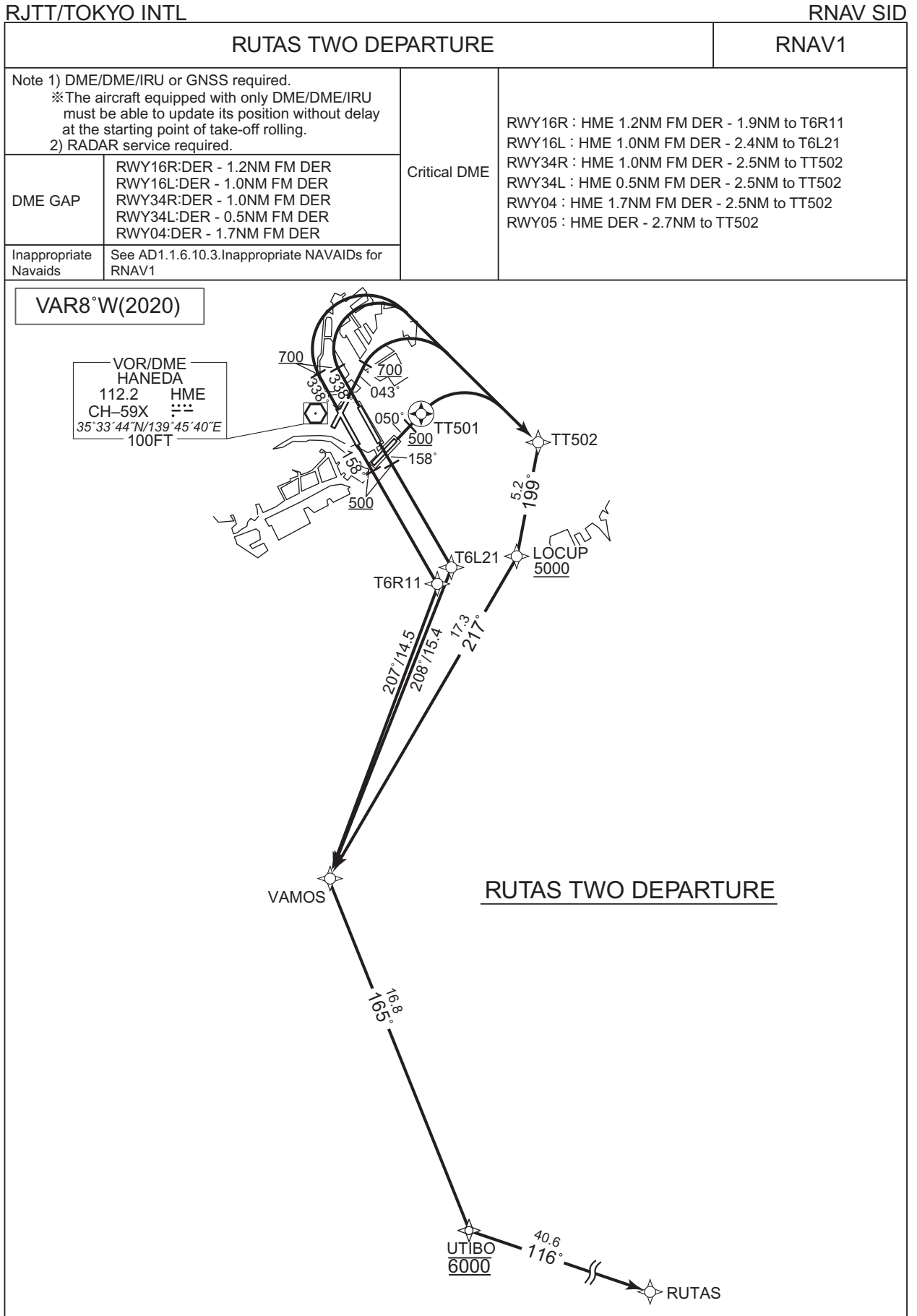

CHANGE : PROC renamed. VAR. HDG after DEP FM RWY04. Course FM TT502 to LOCUP.

STANDARD DEPARTURE CHART-INSTRUMENT

RJTT/TOKYO INTL

RNAV SID

RUTAS TWO DEPARTURE

RWY16R : Climb on HDG 158° at or above 500FT, direct to T6R11, to VAMOS, to UTIBO at 6000FT, to RUTAS.

RWY16L : Climb on HDG 158° at or above 500FT, direct to T6L21, to VAMOS, to UTIBO at 6000FT, to RUTAS.

RWY34L/34R : Climb on HDG 338° at or above 700FT, turn right direct to TT502, to LOCUP at or above 5000FT, to VAMOS, to UTIBO at 6000FT, to RUTAS.

RWY04: Climb on HDG 043° at or above 700FT, turn right direct to TT502, to LOCUP at or above 5000FT, to VAMOS, to UTIBO at 6000FT, to RUTAS.

RWY05: Climb on HDG 050° at or above 500FT, direct to TT501, turn right direct to TT502, to LOCUP at or above 5000FT, to VAMOS, to UTIBO at 6000FT, to RUTAS.

Note RWY34L/34R/04 : 5.0% climb gradient required up to 700FT.  
RWY05 : 5.0% climb gradient required up to 500FT.

RWY16R

Serial Number	Path Descriptor	Waypoint Identifier	Fly Over	Course °M(°T)	Magnetic Variation	Distance (NM)	Turn Direction	Altitude (FT)	Speed (KIAS)	Vertical Angle	Navigation Specification
001	VA	-	-	158 (150.0)	-7.6	-	-	+500	-	-	RNAV1
002	DF	T6R11	-	-	-7.6	-	-	-	-	-	RNAV1
003	TF	VAMOS	-	207 (199.5)	-7.6	14.5	-	-	-	-	RNAV1
004	TF	UTIBO	-	165 (157.0)	-7.6	16.8	-	6000	-	-	RNAV1
005	TF	RUTAS	-	116 (108.4)	-7.6	40.6	-	-	-	-	RNAV1

RWY16L

Serial Number	Path Descriptor	Waypoint Identifier	Fly Over	Course °M(°T)	Magnetic Variation	Distance (NM)	Turn Direction	Altitude (FT)	Speed (KIAS)	Vertical Angle	Navigation Specification
001	VA	-	-	158 (150.0)	-7.6	-	-	+500	-	-	RNAV1
002	DF	T6L21	-	-	-7.6	-	-	-	-	-	RNAV1
003	TF	VAMOS	-	208 (200.7)	-7.6	15.4	-	-	-	-	RNAV1
004	TF	UTIBO	-	165 (157.0)	-7.6	16.8	-	6000	-	-	RNAV1
005	TF	RUTAS	-	116 (108.4)	-7.6	40.6	-	-	-	-	RNAV1

CHANGE : PROC renamed. Magnetic Variation. HDG after DEP FM RWY04.

STANDARD DEPARTURE CHART-INSTRUMENT

RJTT/TOKYO INTL

RNAV SID

RWY34L/RWY34R

Serial Number	Path Descriptor	Waypoint Identifier	Fly Over	Course °M(°T)	Magnetic Variation	Distance (NM)	Turn Direction	Altitude (FT)	Speed (KIAS)	Vertical Angle	Navigation Specification
001	VA	-	-	338 (330.0)	-7.6	-	-	+700	-	-	RNAV1
002	DF	TT502	-	-	-7.6	-	R	-	-	-	RNAV1
003	TF	LOCUP	-	199 (190.9)	-7.6	5.2	-	+5000	-	-	RNAV1
004	TF	VAMOS	-	217 (209.5)	-7.6	17.3	-	-	-	-	RNAV1
005	TF	UTIBO	-	165 (157.0)	-7.6	16.8	-	6000	-	-	RNAV1
006	TF	RUTAS	-	116 (108.4)	-7.6	40.6	-	-	-	-	RNAV1

RWY04

Serial Number	Path Descriptor	Waypoint Identifier	Fly Over	Course °M(°T)	Magnetic Variation	Distance (NM)	Turn Direction	Altitude (FT)	Speed (KIAS)	Vertical Angle	Navigation Specification
001	VA	-	-	043 (034.9)	-7.6	-	-	+700	-	-	RNAV1
002	DF	TT502	-	-	-7.6	-	R	-	-	-	RNAV1
003	TF	LOCUP	-	199 (190.9)	-7.6	5.2	-	+5000	-	-	RNAV1
004	TF	VAMOS	-	217 (209.5)	-7.6	17.3	-	-	-	-	RNAV1
005	TF	UTIBO	-	165 (157.0)	-7.6	16.8	-	6000	-	-	RNAV1
006	TF	RUTAS	-	116 (108.4)	-7.6	40.6	-	-	-	-	RNAV1

RWY05

Serial Number	Path Descriptor	Waypoint Identifier	Fly Over	Course °M(°T)	Magnetic Variation	Distance (NM)	Turn Direction	Altitude (FT)	Speed (KIAS)	Vertical Angle	Navigation Specification
001	VA	-	-	050 (042.4)	-7.6	-	-	+500	-	-	RNAV1
002	DF	TT501	Y	-	-7.6	-	-	-	-	-	RNAV1
003	DF	TT502	-	-	-7.6	-	R	-	-	-	RNAV1
004	TF	LOCUP	-	199 (190.9)	-7.6	5.2	-	+5000	-	-	RNAV1
005	TF	VAMOS	-	217 (209.5)	-7.6	17.3	-	-	-	-	RNAV1
006	TF	UTIBO	-	165 (157.0)	-7.6	16.8	-	6000	-	-	RNAV1
007	TF	RUTAS	-	116 (108.4)	-7.6	40.6	-	-	-	-	RNAV1

Waypoint Coordinates

Waypoint Identifier	Coordinates	Waypoint Identifier	Coordinates
LOCUP	352718.8N / 1395608.5E	TT501	353328.7N / 1395029.9E
RUTAS	344349.3N / 1404034.2E	TT502	353224.4N / 1395720.7E
T6L21	352639.1N / 1395222.0E	UTIBO	345647.0N / 1395343.9E
T6R11	352552.5N / 1395137.2E	VAMOS	351215.5N / 1394543.6E

CHANGE : Magnetic Variation. RWY34L/RWY34R:NR003(Course). RWY04:NR001,003(Course). RWY05:NR004(Course).

**INTENTIONALLY LEFT BLANK**

STANDARD DEPARTURE CHART-INSTRUMENT

RJTT / TOKYO INTL

SID

SEKIYADO THREE DEPARTURE

RWY04/34R/34L: Climb RWY HDG to 700FT, turn right HDG100° to HME 9.0DME, turn left HDG017° to intercept and proceed via SYE R167 to SYE VOR/DME.  
Cross SYE VOR/DME between 12000FT and FL150.

RWY16R/16L: Climb RWY HDG to intercept and proceed via HME 11.8DME counterclockwise ARC to HME R065, turn right HDG017° to intercept and proceed via SYE R167 to SYE VOR/DME.  
Cross HME R116 at or above 6000FT, cross SYE VOR/DME between 12000FT and FL150.

RWY05 : Climb on HDG059° to HME 10.0DME, turn left HDG017° to intercept and proceed via SYE R167 to SYE VOR/DME.  
Cross SYE VOR/DME between 12000FT and FL150.

Note RWY34R/34L/04: 5.0% climb gradient required up to 700FT.  
RWY05: 5.0% climb gradient required up to 500FT.

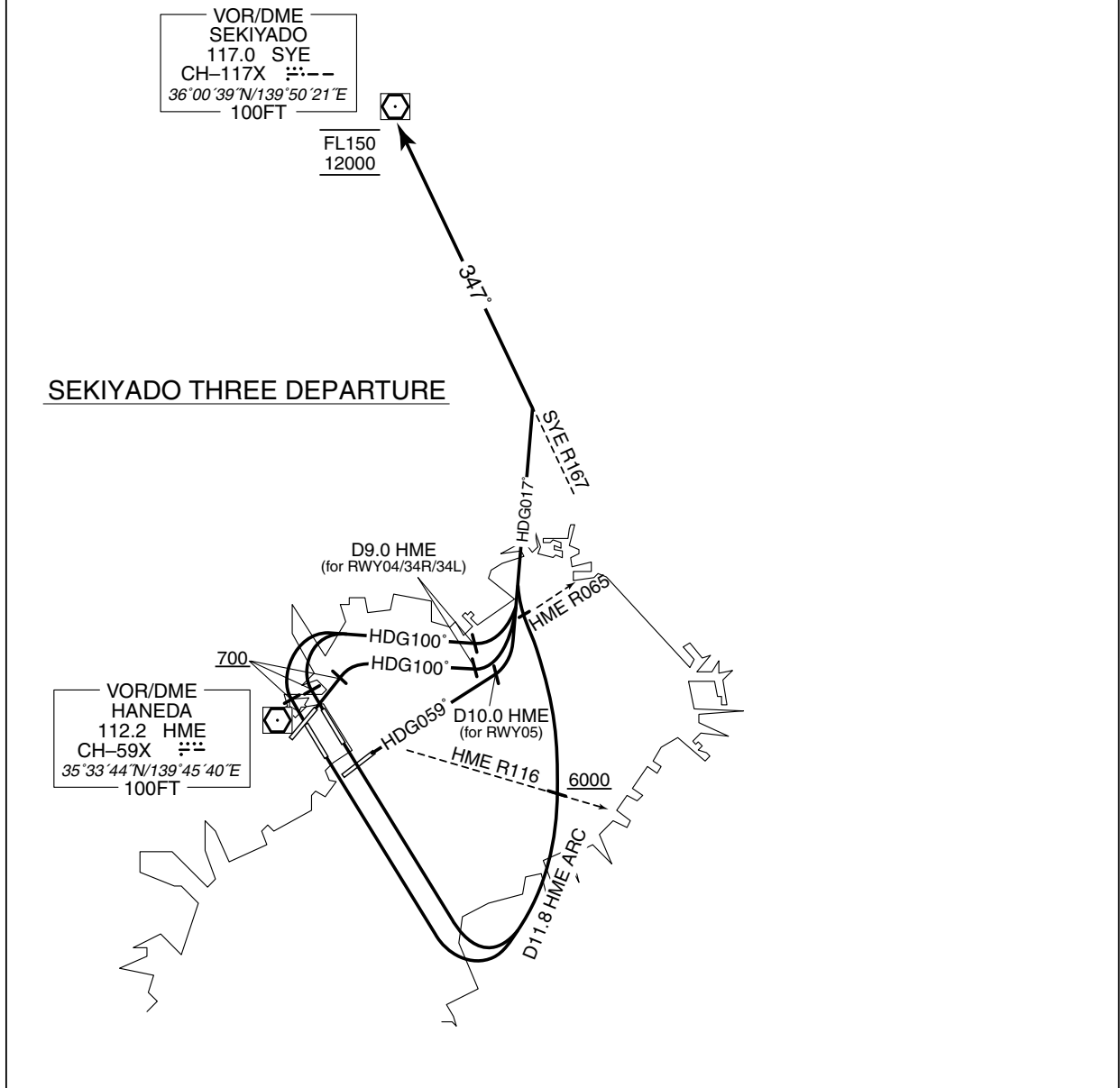

RJTT / TOKYO INTL

AD CHART

CHANGE: TWY CL marking for Y added. TWY CL marking for E4, U4 deleted.

TOKYO INTL AP  
ELEV 6.4m(21ft)

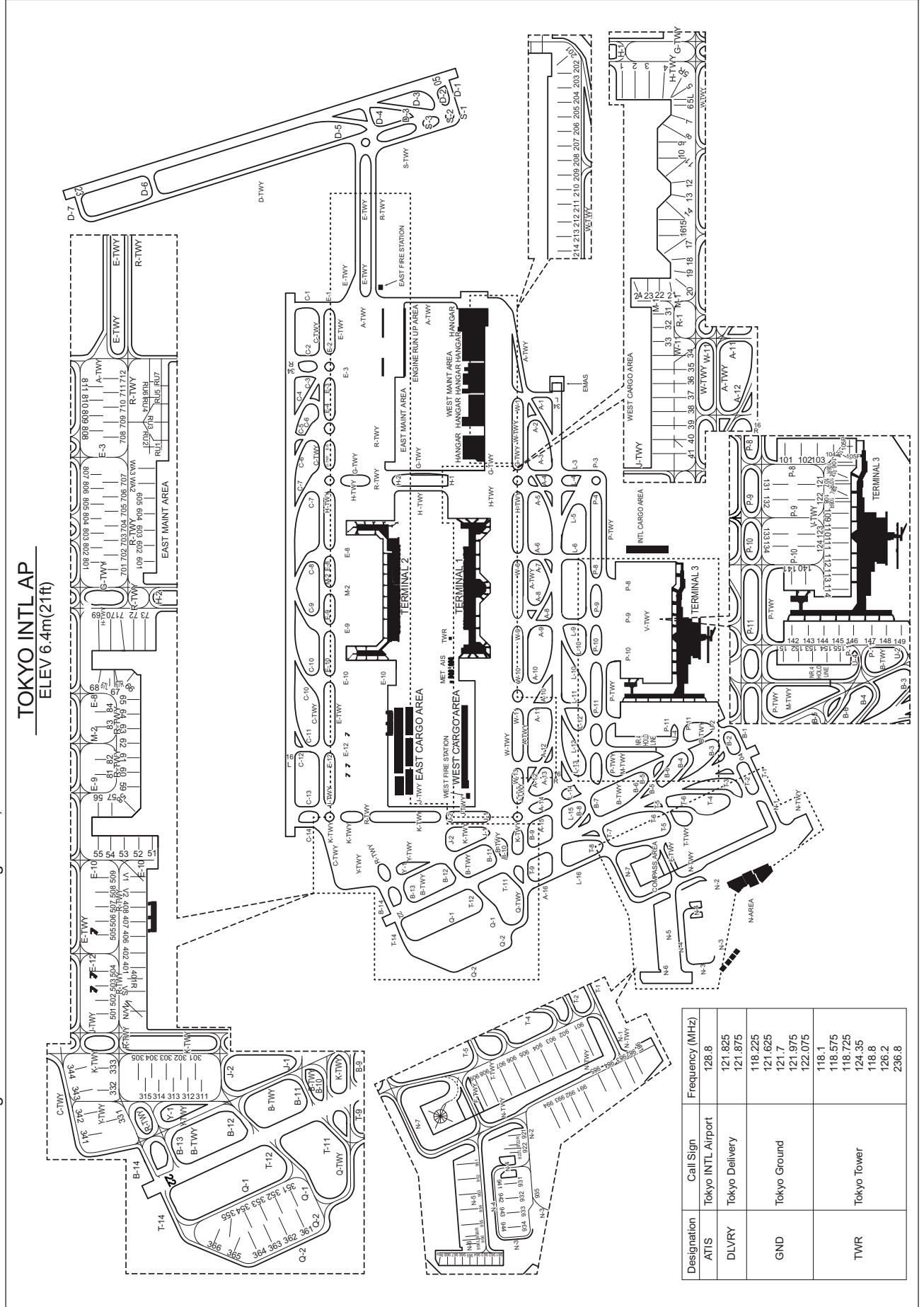

Designation	Call Sign	Frequency (MHz)
ATIS	Tokyo INTL Airport	128.8
	Tokyo Delivery	121.825
		121.875
GND	Tokyo Ground	118.225
		121.625
		121.7
		121.975
TWR	Tokyo Tower	122.075
		118.1
		118.575
		118.725
		124.35
		118.8
		126.2
		236.8

**INTENTIONALLY LEFT BLANK**



STANDARD DEPARTURE CHART-INSTRUMENT

RJTT / TOKYO INTL

SID

VADAR ONE DEPARTURE

RWY04/34R/34L: Climb RWY HDG to 700FT, turn right HDG100° to HME 9.0DME, turn right HDG222° to intercept and proceed via HME R177 to VADAR.  
Cross HME R120 at or above 5000FT, cross VADAR at or above 9000FT.

RWY16R/16L: Climb RWY HDG to HME 7.0DME, turn right HDG207° to intercept and proceed via HME R177 to VADAR.  
Cross VADAR at or above 9000FT.

RWY05: Climb RWY HDG to 1000FT, turn right HDG100° to HME 9.0DME, turn right HDG222° to intercept and proceed via HME R177 to VADAR.  
Cross HME R120 at or above 5000FT, cross VADAR at or above 9000FT.

Note RWY04/34R/34L: 5.0% climb gradient required up to 700FT.  
RWY05: 5.0% climb gradient required up to 1000FT.

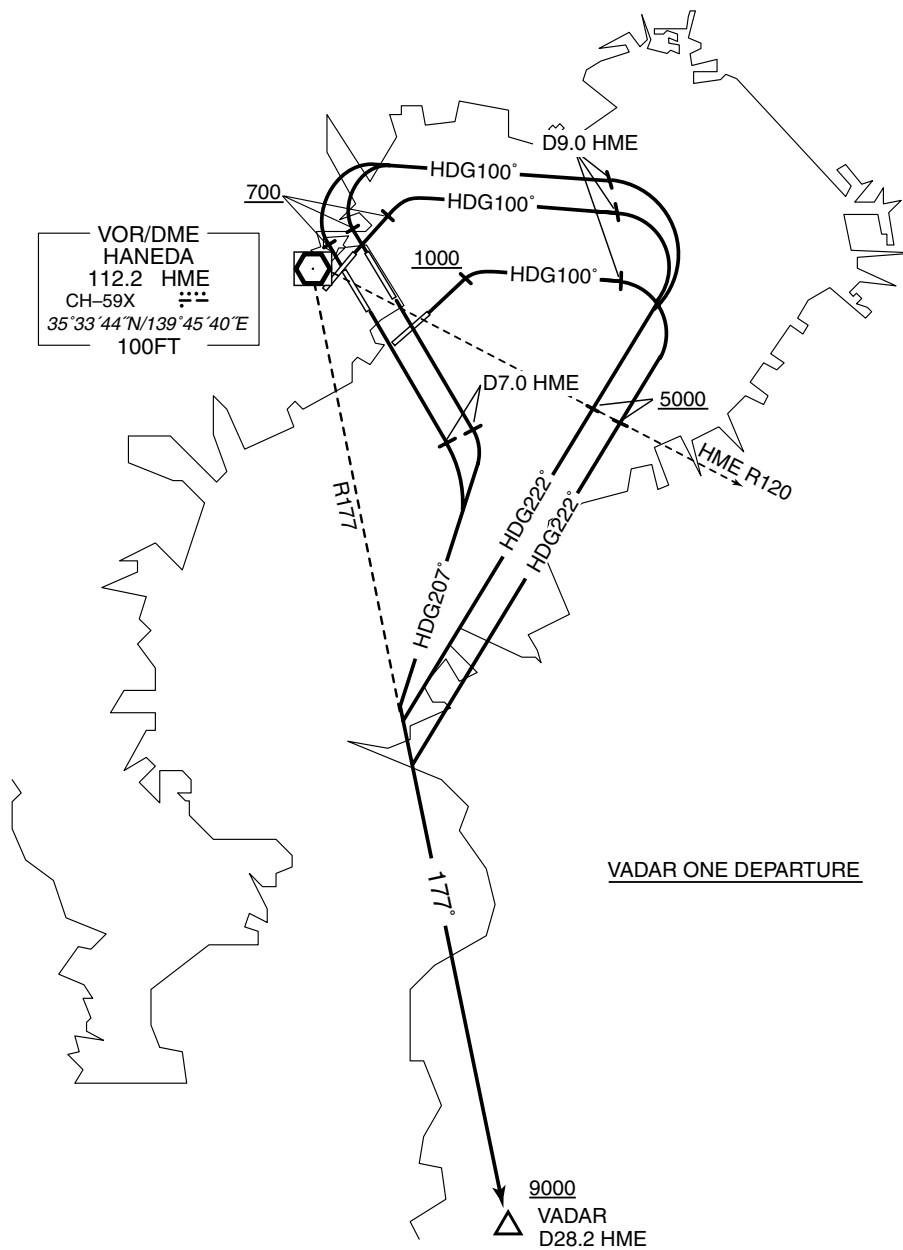

STANDARD DEPARTURE CHART-INSTRUMENT

RJTT / TOKYO INTL

SID

**OPPAR THREE DEPARTURE**

RWY04/34R/34L: Climb RWY HDG to 700FT, turn right within 4NM, climb via HDG110° to HME 7.0DME, turn right, via HME 8.0DME clockwise ARC to intercept and proceed via HME R194 to OPPAR.

Cross HME 7.0DME at or above 3000FT, cross HME R120 at or above 5000FT, cross OPPAR at or above 9000FT.

RWY16R/16L: Climb RWY HDG to 500FT, turn left climb via HME R140 to 8.0DME, turn left HDG239° within HME 12.0DME to intercept and proceed via HME R194 to OPPAR.

Cross OPPAR at or above 9000FT.

RWY05: Climb RWY HDG to HME 5.0DME, turn right, via HME 8.0DME clockwise ARC to intercept and proceed via HME R194 to OPPAR.

Cross HME R120 at or above 5000FT, cross OPPAR at or above 9000FT.

Note Aircraft taking off from RWY16R/16L are required to complete left turns south of HME R080.

RWY34R/34L/04: 5.0% climb gradient required up to 700FT.

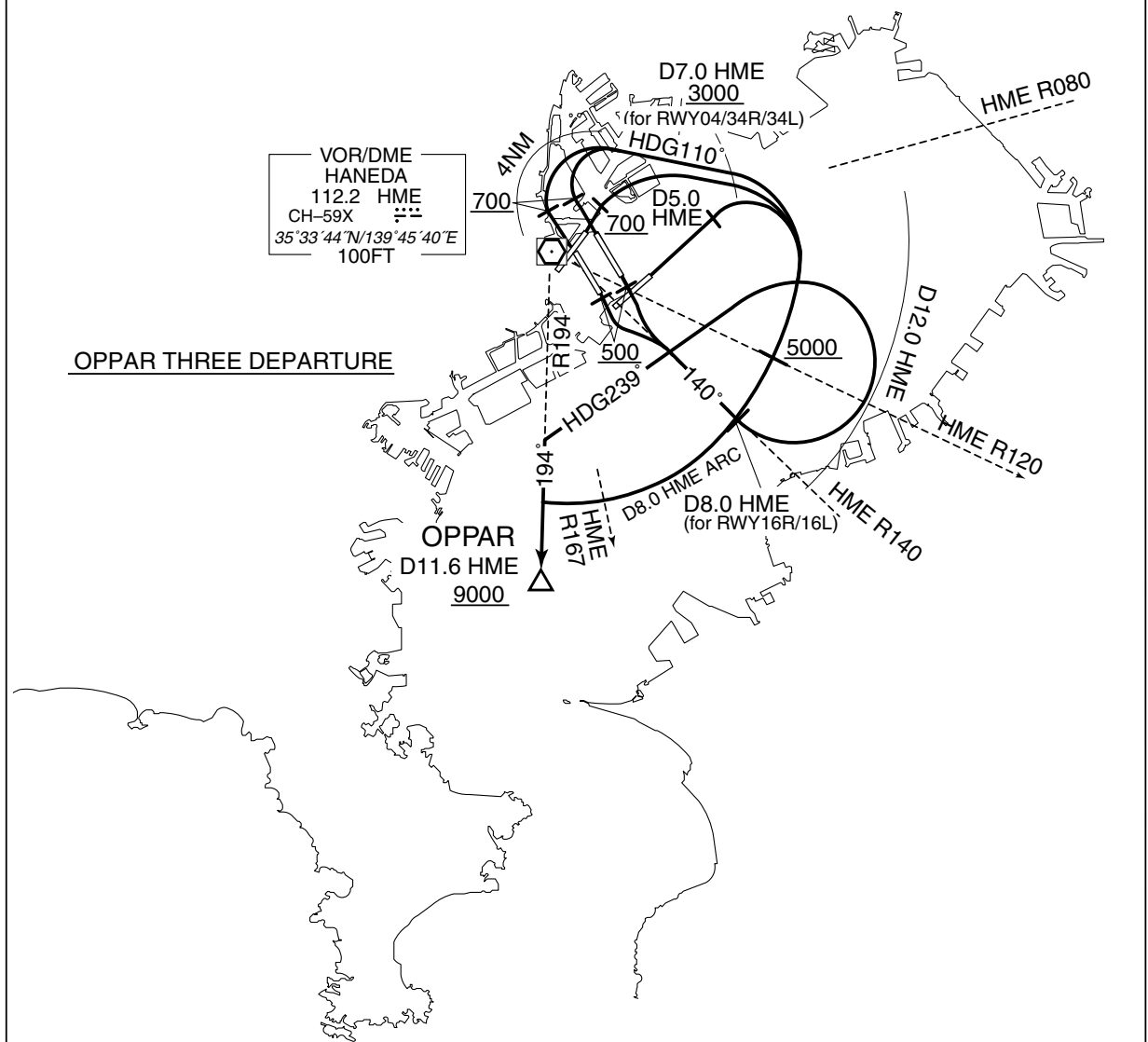

STANDARD DEPARTURE CHART-INSTRUMENT

RJTT / TOKYO INTL

RNAV TRANSITION

JYOGA TRANSITION UTIBO TRANSITION		RNAV1
Note 1 ) DME/DME/IRU or GNSS required.  2 ) RADAR service required.	Critical DME	-
	DME GAP	-
	Inappropriate Nav aids	See AD1.1.6.10.3. Inappropriate NAVAIDs for RNAV1

VAR 7° W(2016)

JYOGA TRANSITION

DME  
YOKOSUKA  
1196 HYD  
CH-109X ≡≡≡-  
35°15'20"N/139°35'15"E  
500FT

JYOGA  
350845.7N  
1393134.9E

FL150

OPPAR  
352215.7N  
1394404.4E  
9000

16.9  
22.4°

UTIBO TRANSITION

26.7  
170°

UTIBO  
345647.0N  
1395343.9E

FL150

JYOGA TRANSITION

From OPPAR at or above 9000FT, to JYOGA at or above FL150.

UTIBO TRANSITION

From OPPAR at or above 9000FT, to UTIBO at or above FL150.

STANDARD DEPARTURE CHART-INSTRUMENT

RJTT / TOKYO INTL

RNAV TRANSITION

JYOGA TRANSITION

Serial Number	Path Descriptor	Waypoint Identifier	Fly Over	Course °M(°T)	Magnetic Variation	Distance (NM)	Turn Direction	Altitude (FT)	Speed (KIAS)	Vertical Angle	Navigation Specification
001	IF	OPPAR	—	—	-7.4	—	—	+9000	—	—	RNAV1
002	TF	JYOGA	—	224 (217.1)	-7.4	16.9	—	+FL150	—	—	RNAV1

UTIBO TRANSITION

Serial Number	Path Descriptor	Waypoint Identifier	Fly Over	Course °M(°T)	Magnetic Variation	Distance (NM)	Turn Direction	Altitude (FT)	Speed (KIAS)	Vertical Angle	Navigation Specification
001	IF	OPPAR	—	—	-7.4	—	—	+9000	—	—	RNAV1
002	TF	UTIBO	—	170 (162.7)	-7.4	26.7	—	+FL150	—	—	RNAV1

**INTENTIONALLY LEFT BLANK**

STANDARD ARRIVAL CHART-INSTRUMENT

RJTT / TOKYO INTL

RNAV STAR RWY22/23

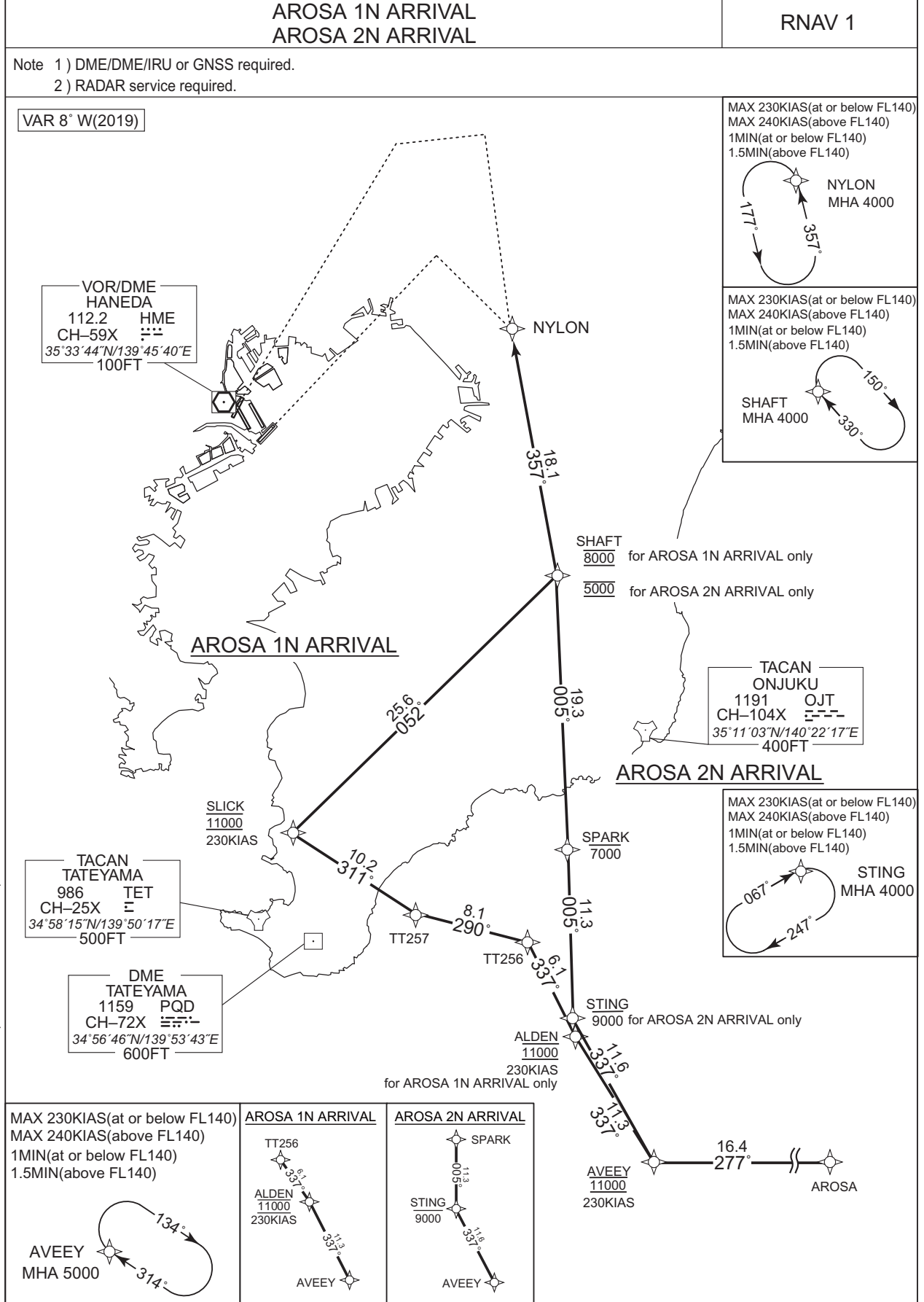

CHANGE : RTE FM AVEEY to TT256 (ALDEN established)

STANDARD ARRIVAL CHART-INSTRUMENT

RJTT / TOKYO INTL

RNAV STAR RWY22/23

AROSA 1N ARRIVAL

From AROSA, to AVEEY at 11000FT, to ALDEN at 11000FT, to TT256, to TT257, to SLICK at 11000FT, to SHAFT at 8000FT, to NYLON.

Critical DME	-
DME GAP	-
Inappropriate Navaids	See AD1.1.6.10.3. Inappropriate NAVAIDs for RNAV1

Serial Number	Path Descriptor	Waypoint Identifier	Fly Over	Course °M(°T)	Magnetic Variation	Distance (NM)	Turn Direction	Altitude (FT)	Speed (KIAS)	Vertical Angle	Navigation Specification
001	IF	AROSA	-	-	-7.5	-	-	-	-	-	RNAV1
002	TF	AVEEY	-	277 (269.8)	-7.5	16.4	-	11000	230	-	RNAV1
003	TF	ALDEN	-	337 (330.0)	-7.5	11.3	-	11000	230	-	RNAV1
004	TF	TT256	-	337 (329.9)	-7.5	6.1	-	-	-	-	RNAV1
005	TF	TT257	-	290 (282.4)	-7.5	8.1	-	-	-	-	RNAV1
006	TF	SLICK	-	311 (303.1)	-7.5	10.2	-	11000	230	-	RNAV1
007	TF	SHAFT	-	052 (044.3)	-7.5	25.6	-	8000	-	-	RNAV1
008	TF	NYLON	-	357 (350.0)	-7.5	18.1	-	-	-	-	RNAV1

Path	Waypoint Identifier	Inbound Course °M(°T)	Magnetic Variation	Outbound Time (MIN)	Outbound Distance (NM)	Turn Direction	Minimum Altitude (FT)	Maximum Altitude (FT)	Speed (KIAS)	Navigation Specification
Hold	AVEEY	314 (306.1)	-7.5	1.0(-14000) 1.5(+14001)	-	R	5000	-	-230(-14000) -240(+14001)	RNAV1
Hold	SHAFT	330 (322.4)	-7.5	1.0(-14000) 1.5(+14001)	-	R	4000	-	-230(-14000) -240(+14001)	RNAV1
Hold	NYLON	357 (350.0)	-7.5	1.0(-14000) 1.5(+14001)	-	L	4000	-	-230(-14000) -240(+14001)	RNAV1

CHANGE : RTE FM AVEEY to TT256 (ALDEN established). HLDG pattern at STING deleted.

STANDARD ARRIVAL CHART-INSTRUMENT

RJTT / TOKYO INTL

RNAV STAR RWY22/23

AROSA 2N ARRIVAL

From AROSA, to AVEEY at 11000FT, to STING at or below 9000FT, to SPARK at or below 7000FT, to SHAFT at 5000FT, to NYLON.

Critical DME	-
DME GAP	-
Inappropriate Nav aids	See AD1.1.6.10.3. Inappropriate NAVAIDs for RNAV1

Serial Number	Path Descriptor	Waypoint Identifier	Fly Over	Course °M(°T)	Magnetic Variation	Distance (NM)	Turn Direction	Altitude (FT)	Speed (KIAS)	Vertical Angle	Navigation Specification
001	IF	AROSA	-	-	-7.5	-	-	-	-	-	RNAV1
002	TF	AVEEY	-	277 (269.8)	-7.5	16.4	-	11000	230	-	RNAV1
003	TF	STING	-	337 (330.0)	-7.5	11.6	-	-9000	-	-	RNAV1
004	TF	SPARK	-	005 (357.4)	-7.5	11.3	-	-7000	-	-	RNAV1
005	TF	SHAFT	-	005 (357.4)	-7.5	19.3	-	5000	-	-	RNAV1
006	TF	NYLON	-	357 (350.0)	-7.5	18.1	-	-	-	-	RNAV1

Path	Waypoint Identifier	Inbound Course °M(°T)	Magnetic Variation	Outbound Time (MIN)	Outbound Distance (NM)	Turn Direction	Minimum Altitude (FT)	Maximum Altitude (FT)	Speed (KIAS)	Navigation Specification
Hold	AVEEY	314 (306.1)	-7.5	1.0(-14000) 1.5(+14001)	-	R	5000	-	-230(-14000) -240(+14001)	RNAV1
Hold	STING	067 (059.6)	-7.5	1.0(-14000) 1.5(+14001)	-	R	4000	-	-230(-14000) -240(+14001)	RNAV1
Hold	SHAFT	330 (322.4)	-7.5	1.0(-14000) 1.5(+14001)	-	R	4000	-	-230(-14000) -240(+14001)	RNAV1
Hold	NYLON	357 (350.0)	-7.5	1.0(-14000) 1.5(+14001)	-	L	4000	-	-230(-14000) -240(+14001)	RNAV1

Waypoint Coordinates

Waypoint Identifier	Coordinates	Waypoint Identifier	Coordinates
ALDEN	345141.1N / 1401505.3E	SLICK	350412.7N / 1395120.0E
AROSA	344201.7N / 1404157.3E	SPARK	350312.0N / 1401416.7E
AVEEY	344155.9N / 1402158.0E	STING	345157.9N / 1401453.4E
NYLON	354018.5N / 1400919.9E	TT256	345655.4N / 1401122.9E
SHAFT	352227.4N / 1401313.3E	TT257	345838.5N / 1400146.6E

CHANGE : ALDEN established



STANDARD DEPARTURE CHART-INSTRUMENT

RJTT / TOKYO INTL

SID

**ISOGO TWO DEPARTURE (FOR PROP ONLY)**

RWY04/34R/34L: Climb RWY HDG to 700FT or above, turn left within 4NM, climb via HME R177 to VADAR.

RWY16R/16L: Climb RWY HDG to HME 7.0DME, turn right HDG207° to intercept and proceed via HME R177 to VADAR.

RWY05: Climb RWY HDG to 1000FT, turn right HDG100° to HME 9.0DME, turn right HDG222° to intercept and proceed via HME R177 to VADAR.

Cross HME R120 at or above 5000FT.

Note RWY34R/34L/04: 5.0% climb gradient required up to 700FT.

RWY05: 5.0% climb gradient required up to 1000FT.

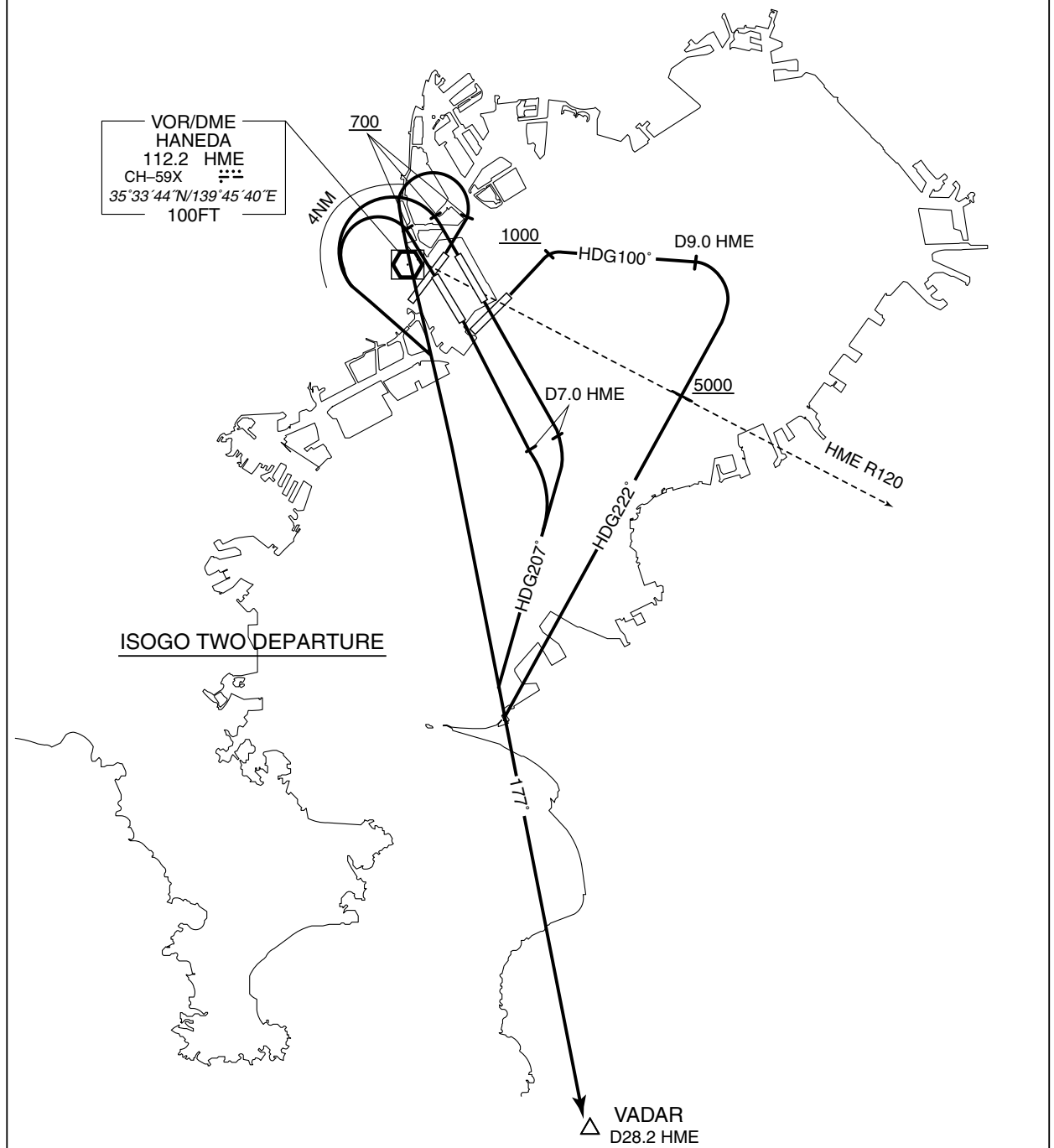

STANDARD DEPARTURE CHART-INSTRUMENT

RJTT / TOKYO INTL

TRANSITION

OSHIMA TRANSITION

From over VADAR, via HME R177 to intercept and proceed via XAC R058 to XAC VORTAC.

CHIKURA TRANSITION

From over VADAR, via HME R177 to UTIBO.

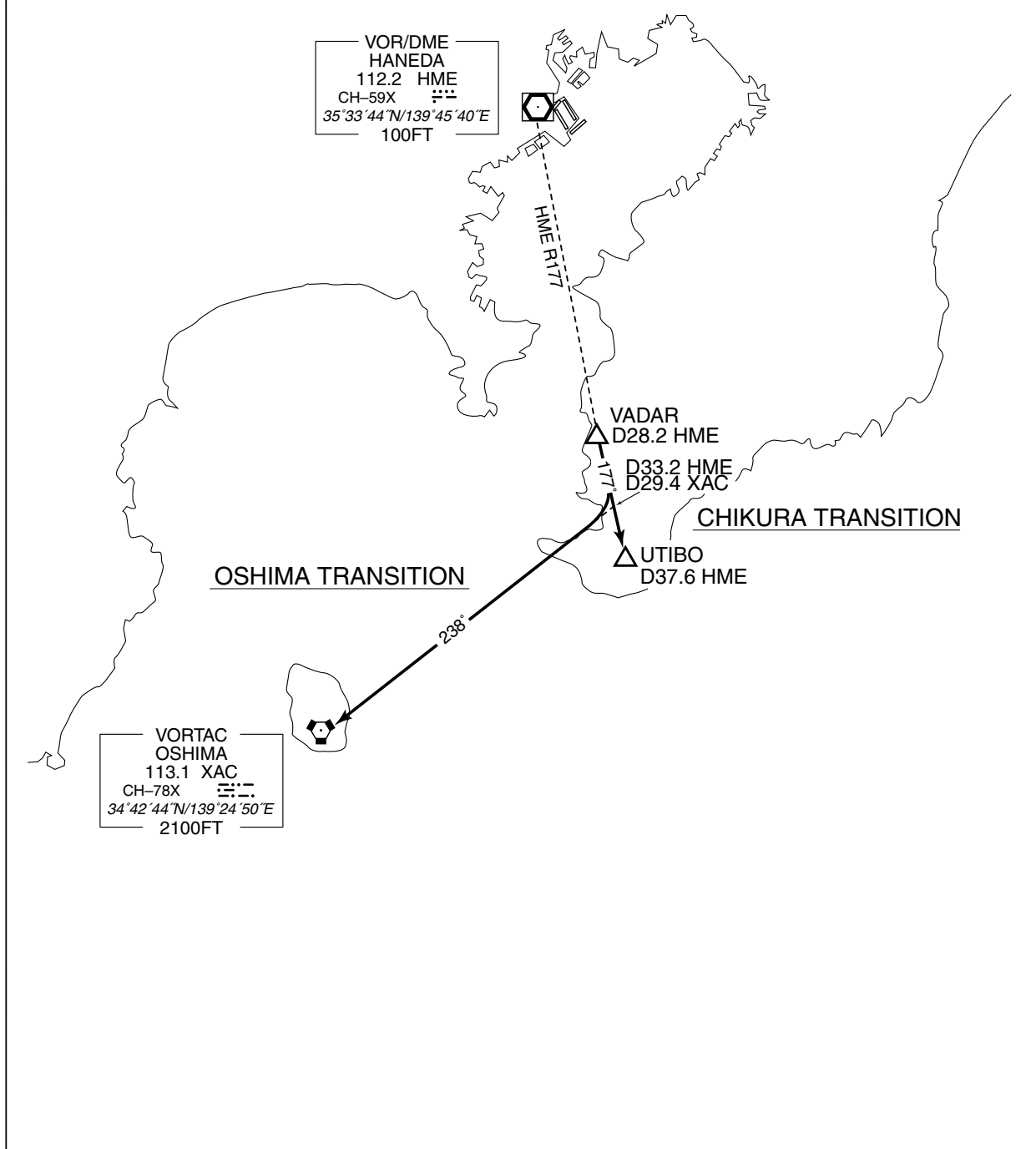

STANDARD ARRIVAL CHART-INSTRUMENT

RJTT / TOKYO INTL

RNAV STAR RWY22/23

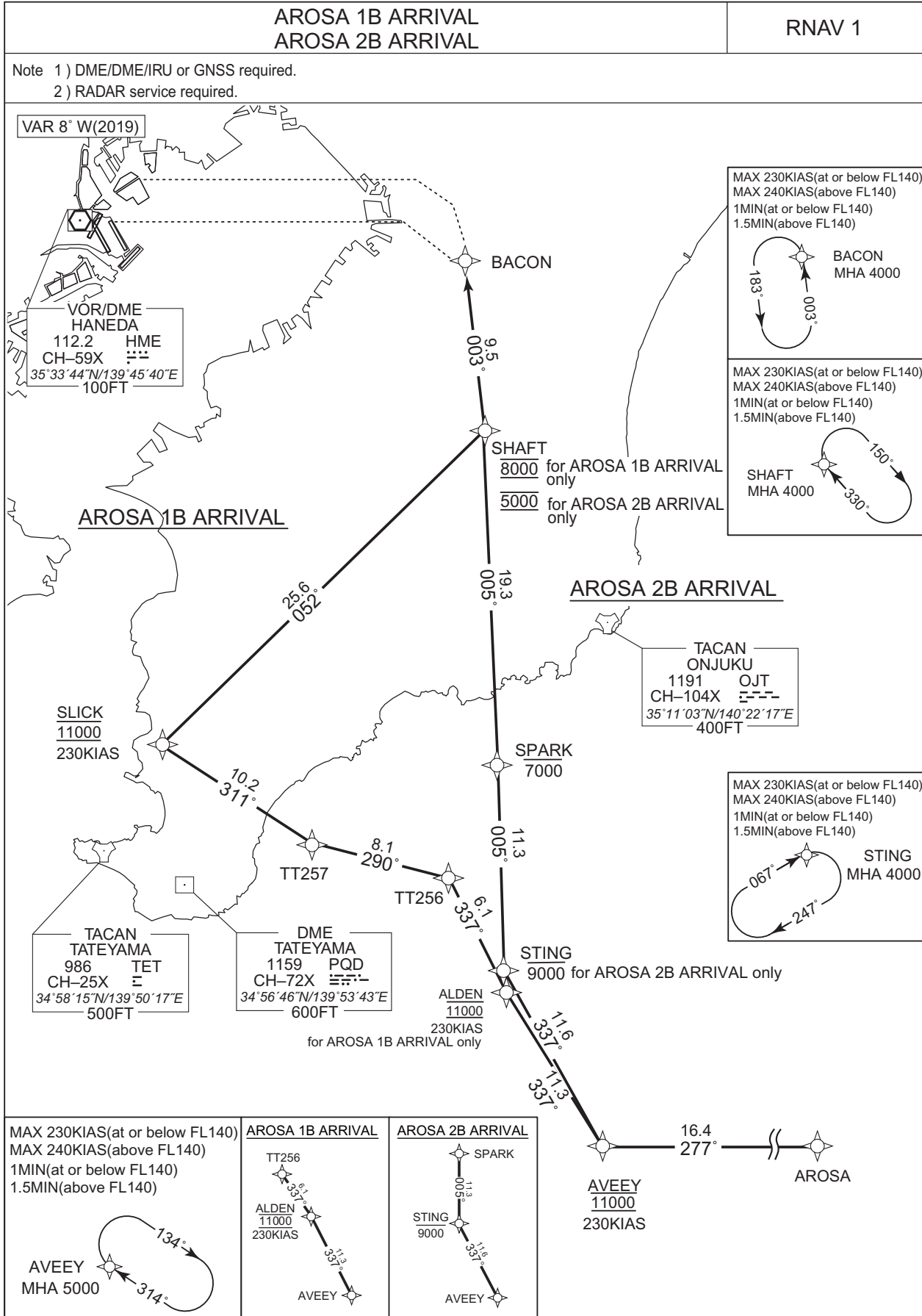

STANDARD ARRIVAL CHART-INSTRUMENT

RJTT / TOKYO INTL

RNAV STAR RWY22/23

AROSA 1B ARRIVAL

From AROSA, to AVEEY at 11000FT, to ALDEN at 11000FT, to TT256, to TT257, to SLICK at 11000FT, to SHAFT at 8000FT, to BACON.

Critical DME	-
DME GAP	-
Inappropriate Nav aids	See AD1.1.6.10.3. Inappropriate NAVAIDs for RNAV1

Serial Number	Path Descriptor	Waypoint Identifier	Fly Over	Course °M(°T)	Magnetic Variation	Distance (NM)	Turn Direction	Altitude (FT)	Speed (KIAS)	Vertical Angle	Navigation Specification
001	IF	AROSA	-	-	-7.5	-	-	-	-	-	RNAV1
002	TF	AVEEY	-	277 (269.8)	-7.5	16.4	-	11000	230	-	RNAV1
003	TF	ALDEN	-	337 (330.0)	-7.5	11.3	-	11000	230	-	RNAV1
004	TF	TT256	-	337 (329.9)	-7.5	6.1	-	-	-	-	RNAV1
005	TF	TT257	-	290 (282.4)	-7.5	8.1	-	-	-	-	RNAV1
006	TF	SLICK	-	311 (303.1)	-7.5	10.2	-	11000	230	-	RNAV1
007	TF	SHAFT	-	052 (044.3)	-7.5	25.6	-	8000	-	-	RNAV1
008	TF	BACON	-	003 (355.2)	-7.5	9.5	-	-	-	-	RNAV1

Path	Waypoint Identifier	Inbound Course °M(°T)	Magnetic Variation	Outbound Time (MIN)	Outbound Distance (NM)	Turn Direction	Minimum Altitude (FT)	Maximum Altitude (FT)	Speed (KIAS)	Navigation Specification
Hold	AVEEY	314 (306.1)	-7.5	1.0(-14000) 1.5(+14001)	-	R	5000	-	-230(-14000) -240(+14001)	RNAV1
Hold	SHAFT	330 (322.4)	-7.5	1.0(-14000) 1.5(+14001)	-	R	4000	-	-230(-14000) -240(+14001)	RNAV1
Hold	BACON	003 (355.2)	-7.5	1.0(-14000) 1.5(+14001)	-	L	4000	-	-230(-14000) -240(+14001)	RNAV1

CHANGE : RTE FM AVEEY to TT256 (ALDEN established). HLDG pattern at STING deleted.

## STANDARD ARRIVAL CHART-INSTRUMENT

RJTT / TOKYO INTL

RNAV STAR RWY22/23

AROSA 2B ARRIVAL

From AROSA, to AVEEY at 11000FT, to STING at or below 9000FT , to SPARK at or below 7000FT, to SHAFT at 5000FT, to BACON.

Critical DME	-
DME GAP	-
Inappropriate Nav aids	See AD1.1.6.10.3. Inappropriate NAVAIDs for RNAV1

Serial Number	Path Descriptor	Waypoint Identifier	Fly Over	Course °M(°T)	Magnetic Variation	Distance (NM)	Turn Direction	Altitude (FT)	Speed (KIAS)	Vertical Angle	Navigation Specification
001	IF	AROSA	-	-	-7.5	-	-	-	-	-	RNAV1
002	TF	AVEEY	-	277 (269.8)	-7.5	16.4	-	11000	230	-	RNAV1
003	TF	STING	-	337 (330.0)	-7.5	11.6	-	-9000	-	-	RNAV1
004	TF	SPARK	-	005 (357.4)	-7.5	11.3	-	-7000	-	-	RNAV1
005	TF	SHAFT	-	005 (357.4)	-7.5	19.3	-	5000	-	-	RNAV1
006	TF	BACON	-	003 (355.2)	-7.5	9.5	-	-	-	-	RNAV1

Path	Waypoint Identifier	Inbound Course °M(°T)	Magnetic Variation	Outbound Time (MIN)	Outbound Distance (NM)	Turn Direction	Minimum Altitude (FT)	Maximum Altitude (FT)	Speed (KIAS)	Navigation Specification
Hold	AVEEY	314 (306.1)	-7.5	1.0(-14000) 1.5(+14001)	-	R	5000	-	-230(-14000) -240(+14001)	RNAV1
Hold	STING	067 (059.6)	-7.5	1.0(-14000) 1.5(+14001)	-	R	4000	-	-230(-14000) -240(+14001)	RNAV1
Hold	SHAFT	330 (322.4)	-7.5	1.0(-14000) 1.5(+14001)	-	R	4000	-	-230(-14000) -240(+14001)	RNAV1
Hold	BACON	003 (355.2)	-7.5	1.0(-14000) 1.5(+14001)	-	L	4000	-	-230(-14000) -240(+14001)	RNAV1

Waypoint Coordinates

Waypoint Identifier	Coordinates	Waypoint Identifier	Coordinates
ALDEN	345141.1N / 1401505.3E	SLICK	350412.7N / 1395120.0E
AROSA	344201.7N / 1404157.3E	SPARK	350312.0N / 1401416.7E
AVEEY	344155.9N / 1402158.0E	STING	345157.9N / 1401453.4E
BACON	353155.0N / 1401215.1E	TT256	345655.4N / 1401122.9E
SHAFT	352227.4N / 1401313.3E	TT257	345838.5N / 1400146.6E

CHANGE : ALDEN established

STANDARD ARRIVAL CHART-INSTRUMENT

RJTT / TOKYO INTL RNAV STAR RWY34R/34L

**OSHIMA 1A ARRIVAL / OSHIMA 1K ARRIVAL** **RNAV 1**  
**OSHIMA 2C ARRIVAL**

Note 1) DME/DME/IRU or GNSS required.  
2) RADAR service required.

VAR 8° W(2019)

MAX 230KIAS(at or below FL140)  
MAX 240KIAS(above FL140)  
1MIN(at or below FL140)  
1.5MIN(above FL140)



MAX 230KIAS(at or below FL140)  
MAX 240KIAS(above FL140)  
1MIN(at or below FL140)  
1.5MIN(above FL140)



MAX 230KIAS(at or below FL140)  
MAX 240KIAS(above FL140)  
1MIN(at or below FL140)  
1.5MIN(above FL140)

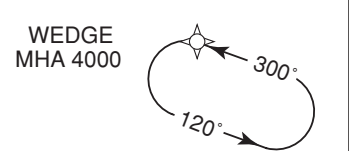

TACAN TATEYAMA  
986 TET  
CH-25X  
34°58'15"N/139°50'17"E  
500FT

VORTAC OSHIMA  
113.1 XAC  
CH-78X  
34°42'44"N/139°24'50"E  
2100FT

OSHIMA (XAC)  
MAX 230KIAS(at or below FL140)  
MAX 240KIAS(above FL140)  
1MIN(at or below FL140)  
1.5MIN(above FL140)

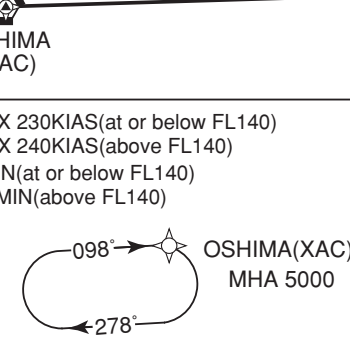

VOR/DME HANEDA  
112.2 HME  
CH-59X  
35°33'44"N/139°45'40"E  
100FT

MAX 230KIAS(at or below FL140)  
MAX 240KIAS(above FL140)  
1MIN(at or below FL140)  
1.5MIN(above FL140)

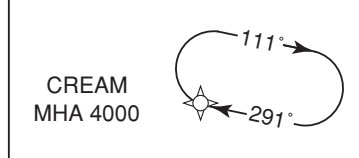

MAX 230KIAS(at or below FL140)  
MAX 240KIAS(above FL140)  
1MIN(at or below FL140)  
1.5MIN(above FL140)

MAX 230KIAS(at or below FL140)  
MAX 240KIAS(above FL140)  
1MIN(at or below FL140)  
1.5MIN(above FL140)

MAX 230KIAS(at or below FL140)  
MAX 240KIAS(above FL140)  
1MIN(at or below FL140)  
1.5MIN(above FL140)

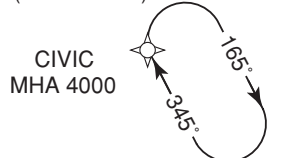

CHANGE : New PROC

STANDARD ARRIVAL CHART-INSTRUMENT

RJTT / TOKYO INTL

RNAV STAR RWY34R/34L

OSHIMA 1A ARRIVAL

From XAC, to ACORN at 13000FT, to TT450, to TT451, to TT452, to TT453, to WANDA at 13000FT, to WEDGE at 8000FT, to ARLON.

Critical DME	-
DME GAP	-
Inappropriate Nav aids	See AD1.1.6.10.3. Inappropriate NAVAIDs for RNAV1

Serial Number	Path Descriptor	Waypoint Identifier	Fly Over	Course °M(°T)	Magnetic Variation	Distance (NM)	Turn Direction	Altitude (FT)	Speed (KIAS)	Vertical Angle	Navigation Specification
001	IF	XAC	-	-	-7.5	-	-	-	-	-	RNAV1
002	TF	ACORN	-	068 (060.8)	-7.5	15.9	-	13000	230	-	RNAV1
003	TF	TT450	-	069 (061.0)	-7.5	5.0	-	-	-	-	RNAV1
004	TF	TT451	-	114 (106.9)	-7.5	9.0	-	-	-	-	RNAV1
005	TF	TT452	-	090 (082.2)	-7.5	7.0	-	-	-	-	RNAV1
006	TF	TT453	-	068 (060.7)	-7.5	7.0	-	-	-	-	RNAV1
007	TF	WANDA	-	044 (036.0)	-7.5	9.0	-	13000	230	-	RNAV1
008	TF	WEDGE	-	300 (292.4)	-7.5	18.7	-	8000	-	-	RNAV1
009	TF	ARLON	-	009 (001.6)	-7.5	6.4	-	-	-	-	RNAV1

Path	Waypoint Identifier	Inbound Course °M(°T)	Magnetic Variation	Outbound Time (MIN)	Outbound Distance (NM)	Turn Direction	Minimum Altitude (FT)	Maximum Altitude (FT)	Speed (KIAS)	Navigation Specification
Hold	XAC	098 (090.3)	-7.5	1.0(-14000) 1.5(+14001)	-	R	5000	-	-230(-14000) -240(+14001)	RNAV1
Hold	ACORN	068 (060.8)	-7.5	1.0(-14000) 1.5(+14001)	-	L	5000	-	-230(-14000) -240(+14001)	RNAV1
Hold	WEDGE	300 (292.4)	-7.5	1.0(-14000) 1.5(+14001)	-	L	4000	-	-230(-14000) -240(+14001)	RNAV1
Hold	ARLON	009 (001.6)	-7.5	1.0(-14000) 1.5(+14001)	-	L	4000	-	-230(-14000) -240(+14001)	RNAV1

CHANGE : New PROC

STANDARD ARRIVAL CHART-INSTRUMENT

RJTT / TOKYO INTL

RNAV STAR RWY34R/34L

OSHIMA 1K ARRIVAL

From XAC, to ACORN at 13000FT, to TT450, to TT451, to TT452, to TT453, to WANDA at 13000FT, to WEDGE at 8000FT, to UMUKI at or above 6000FT, to KAIHO.

Critical DME	-
DME GAP	-
Inappropriate Navaids	See AD1.1.6.10.3. Inappropriate NAVAIDs for RNAV1

Serial Number	Path Descriptor	Waypoint Identifier	Fly Over	Course °M(°T)	Magnetic Variation	Distance (NM)	Turn Direction	Altitude (FT)	Speed (KIAS)	Vertical Angle	Navigation Specification
001	IF	XAC	-	-	-7.5	-	-	-	-	-	RNAV1
002	TF	ACORN	-	068 (060.8)	-7.5	15.9	-	13000	230	-	RNAV1
003	TF	TT450	-	069 (061.0)	-7.5	5.0	-	-	-	-	RNAV1
004	TF	TT451	-	114 (106.9)	-7.5	9.0	-	-	-	-	RNAV1
005	TF	TT452	-	090 (082.2)	-7.5	7.0	-	-	-	-	RNAV1
006	TF	TT453	-	068 (060.7)	-7.5	7.0	-	-	-	-	RNAV1
007	TF	WANDA	-	044 (036.0)	-7.5	9.0	-	13000	230	-	RNAV1
008	TF	WEDGE	-	300 (292.4)	-7.5	18.7	-	8000	-	-	RNAV1
009	TF	UMUKI	-	300 (292.2)	-7.5	8.8	-	+6000	-	-	RNAV1
010	TF	KAIHO	-	353 (345.5)	-7.5	6.9	-	-	-	-	RNAV1

Path	Waypoint Identifier	Inbound Course °M(°T)	Magnetic Variation	Outbound Time (MIN)	Outbound Distance (NM)	Turn Direction	Minimum Altitude (FT)	Maximum Altitude (FT)	Speed (KIAS)	Navigation Specification
Hold	XAC	098 (090.3)	-7.5	1.0(-14000) 1.5(+14001)	-	R	5000	-	-230(-14000) -240(+14001)	RNAV1
Hold	ACORN	068 (060.8)	-7.5	1.0(-14000) 1.5(+14001)	-	L	5000	-	-230(-14000) -240(+14001)	RNAV1
Hold	WEDGE	300 (292.4)	-7.5	1.0(-14000) 1.5(+14001)	-	L	4000	-	-230(-14000) -240(+14001)	RNAV1
Hold	KAIHO	353 (345.5)	-7.5	1.0(-14000) 1.5(+14001)	-	R	4000	-	-230(-14000) -240(+14001)	RNAV1

CHANGE : New PROC



STANDARD ARRIVAL CHART-INSTRUMENT

RJTT / TOKYO INTL

RNAV STAR RWY34R/34L

OSHIMA 2C ARRIVAL

From XAC, to CLONE, to TT460, to TT461, to CIVIC at 7000FT, to TT462, to TT463, to TT464, to EPSON at 7000FT, to CREAM.

Critical DME	-
DME GAP	-
Inappropriate Nav aids	See AD1.1.6.10.3. Inappropriate NAVAIDs for RNAV1

Serial Number	Path Descriptor	Waypoint Identifier	Fly Over	Course °M(^T)	Magnetic Variation	Distance (NM)	Turn Direction	Altitude (FT)	Speed (KIAS)	Vertical Angle	Navigation Specification
001	IF	XAC	-	-	-7.5	-	-	-	-	-	RNAV1
002	TF	CLONE	-	095 (087.8)	-7.5	36.3	-	-	-	-	RNAV1
003	TF	TT460	-	068 (060.7)	-7.5	10.1	-	-	-	-	RNAV1
004	TF	TT461	-	044 (036.1)	-7.5	14.4	-	-	-	-	RNAV1
005	TF	CIVIC	-	345 (337.7)	-7.5	8.8	-	7000	210	-	RNAV1
006	TF	TT462	-	345 (337.7)	-7.5	6.4	-	-	-	-	RNAV1
007	TF	TT463	-	006 (358.0)	-7.5	6.9	-	-	-	-	RNAV1
008	TF	TT464	-	341 (333.5)	-7.5	5.4	-	-	-	-	RNAV1
009	TF	EPSON	-	317 (309.0)	-7.5	6.9	-	7000	210	-	RNAV1
010	TF	CREAM	-	211 (203.6)	-7.5	14.1	-	-	-	-	RNAV1

Path	Waypoint Identifier	Inbound Course °M(^T)	Magnetic Variation	Outbound Time (MIN)	Outbound Distance (NM)	Turn Direction	Minimum Altitude (FT)	Maximum Altitude (FT)	Speed (KIAS)	Navigation Specification
Hold	XAC	098 (090.3)	-7.5	1.0(-14000) 1.5(+14001)	-	R	5000	-	-230(-14000) -240(+14001)	RNAV1
Hold	CIVIC	345 (337.7)	-7.5	1.0(-14000) 1.5(+14001)	-	R	4000	-	-230(-14000) -240(+14001)	RNAV1
Hold	CREAM	291 (283.1)	-7.5	1.0(-14000) 1.5(+14001)	-	R	4000	-	-230(-14000) -240(+14001)	RNAV1

Waypoint Coordinates

Waypoint Identifier	Coordinates	Waypoint Identifier	Coordinates
ACORN	345028.8N / 1394146.7E	TT453	345438.5N / 1401325.9E
ARLON	351525.3N / 1395859.8E	TT460	344852.6N / 1401936.8E
CIVIC	350840.6N / 1402552.1E	TT461	350030.2N / 1402957.9E
CLONE	344357.8N / 1400856.0E	TT462	351433.3N / 1402254.8E
CREAM	351743.4N / 1400612.4E	TT463	352125.4N / 1402237.1E
EPSON	353036.2N / 1401305.9E	TT464	352617.6N / 1401938.6E
KAIHO	351857.8N / 1394642.4E	UMUKI	351219.1N / 1394849.2E
TT450	345254.0N / 1394706.0E	WANDA	350155.3N / 1401954.1E
TT451	345016.8N / 1395734.3E	WEDGE	350900.4N / 1395846.5E
TT452	345113.2N / 1400600.1E	XAC	344244.1N / 1392450.5E

CHANGE : New PROC

STANDARD ARRIVAL CHART-INSTRUMENT

RJTT / TOKYO INTL

RNAV STAR RWY34R/34L

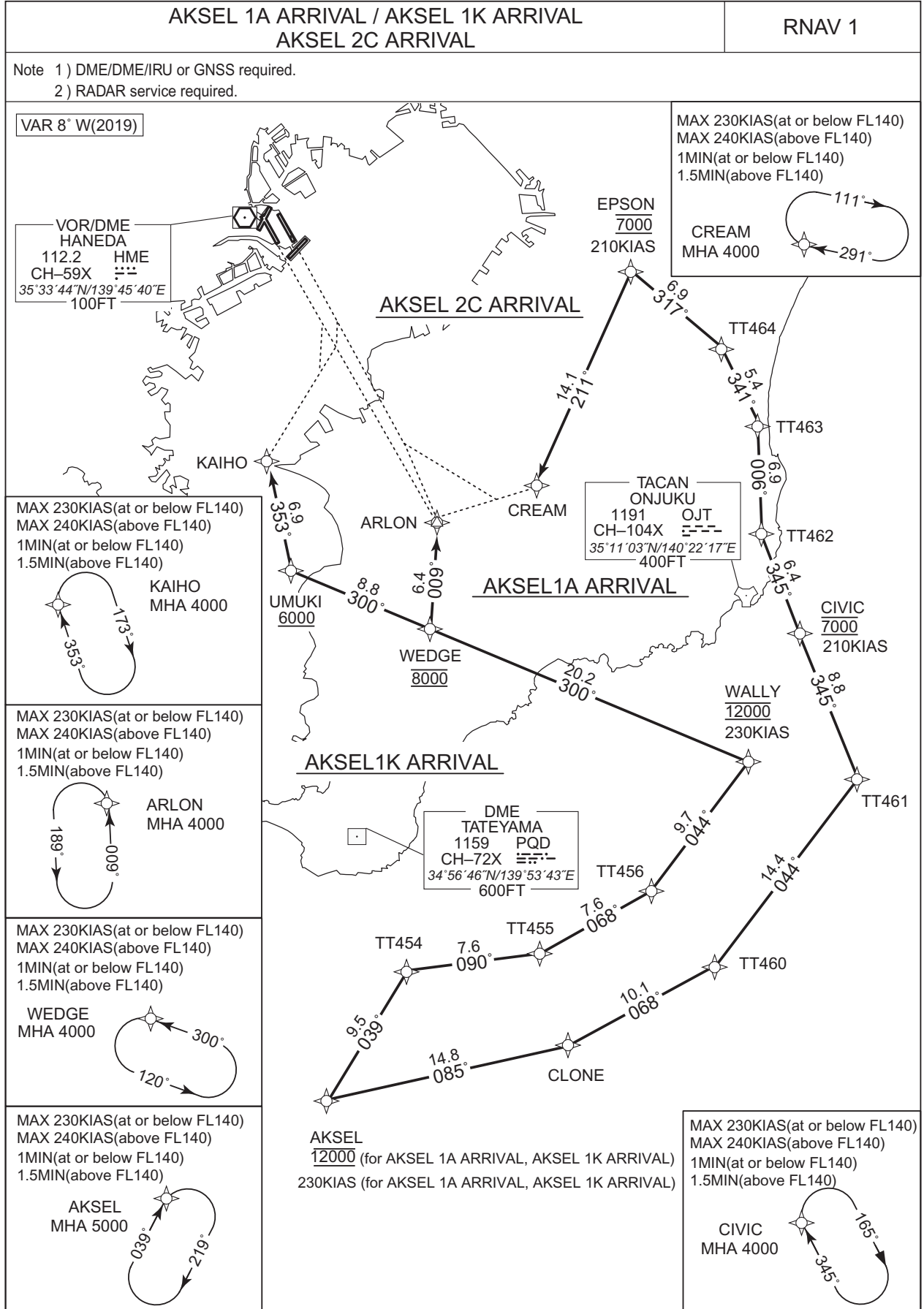

CHANGE : WALLY renamed

STANDARD ARRIVAL CHART-INSTRUMENT

RJTT / TOKYO INTL

RNAV STAR RWY34R/34L

AKSEL 1A ARRIVAL

From AKSEL at 12000FT, to TT454, to TT455, to TT456, to WALLY at 12000FT, to WEDGE at 8000FT, to ARLON.

Critical DME	-
DME GAP	-
Inappropriate Nav aids	See AD1.1.6.10.3. Inappropriate NAVAIDs for RNAV1

Serial Number	Path Descriptor	Waypoint Identifier	Fly Over	Course °M(°T)	Magnetic Variation	Distance (NM)	Turn Direction	Altitude (FT)	Speed (KIAS)	Vertical Angle	Navigation Specification
001	IF	AKSEL	-	-	-7.5	-	-	12000	230	-	RNAV1
002	TF	TT454	-	039 (031.2)	-7.5	9.5	-	-	-	-	RNAV1
003	TF	TT455	-	090 (082.2)	-7.5	7.6	-	-	-	-	RNAV1
004	TF	TT456	-	068 (060.7)	-7.5	7.6	-	-	-	-	RNAV1
005	TF	WALLY	-	044 (036.0)	-7.5	9.7	-	12000	230	-	RNAV1
006	TF	WEDGE	-	300 (292.4)	-7.5	20.2	-	8000	-	-	RNAV1
007	TF	ARLON	-	009 (001.6)	-7.5	6.4	-	-	-	-	RNAV1

Path	Waypoint Identifier	Inbound Course °M(°T)	Magnetic Variation	Outbound Time (MIN)	Outbound Distance (NM)	Turn Direction	Minimum Altitude (FT)	Maximum Altitude (FT)	Speed (KIAS)	Navigation Specification
Hold	AKSEL	039 (031.2)	-7.5	1.0(-14000) 1.5(+14001)	-	R	5000	-	-230(-14000) -240(+14001)	RNAV1
Hold	WEDGE	300 (292.4)	-7.5	1.0(-14000) 1.5(+14001)	-	L	4000	-	-230(-14000) -240(+14001)	RNAV1
Hold	ARLON	009 (001.6)	-7.5	1.0(-14000) 1.5(+14001)	-	L	4000	-	-230(-14000) -240(+14001)	RNAV1

CHANGE : WALLY renamed

STANDARD ARRIVAL CHART-INSTRUMENT

RJTT / TOKYO INTL

RNAV STAR RWY34R/34L

AKSEL 1K ARRIVAL

From AKSEL at 12000FT, to TT454, to TT455, to TT456, to WALLY at 12000FT, to WEDGE at 8000FT, to UMUKI at or above 6000FT, to KAIHO.

Critical DME	-
DME GAP	-
Inappropriate Nav aids	See AD1.1.6.10.3. Inappropriate NAVAIDs for RNAV1

Serial Number	Path Descriptor	Waypoint Identifier	Fly Over	Course °M(°T)	Magnetic Variation	Distance (NM)	Turn Direction	Altitude (FT)	Speed (KIAS)	Vertical Angle	Navigation Specification
001	IF	AKSEL	-	-	-7.5	-	-	12000	230	-	RNAV1
002	TF	TT454	-	039 (031.2)	-7.5	9.5	-	-	-	-	RNAV1
003	TF	TT455	-	090 (082.2)	-7.5	7.6	-	-	-	-	RNAV1
004	TF	TT456	-	068 (060.7)	-7.5	7.6	-	-	-	-	RNAV1
005	TF	WALLY	-	044 (036.0)	-7.5	9.7	-	12000	230	-	RNAV1
006	TF	WEDGE	-	300 (292.4)	-7.5	20.2	-	8000	-	-	RNAV1
007	TF	UMUKI	-	300 (292.2)	-7.5	8.8	-	+6000	-	-	RNAV1
008	TF	KAIHO	-	353 (345.5)	-7.5	6.9	-	-	-	-	RNAV1

Path	Waypoint Identifier	Inbound Course °M(°T)	Magnetic Variation	Outbound Time (MIN)	Outbound Distance (NM)	Turn Direction	Minimum Altitude (FT)	Maximum Altitude (FT)	Speed (KIAS)	Navigation Specification
Hold	AKSEL	039 (031.2)	-7.5	1.0(-14000) 1.5(+14001)	-	R	5000	-	-230(-14000) -240(+14001)	RNAV1
Hold	WEDGE	300 (292.4)	-7.5	1.0(-14000) 1.5(+14001)	-	L	4000	-	-230(-14000) -240(+14001)	RNAV1
Hold	KAIHO	353 (345.5)	-7.5	1.0(-14000) 1.5(+14001)	-	R	4000	-	-230(-14000) -240(+14001)	RNAV1

CHANGE : WALLY renamed

STANDARD ARRIVAL CHART-INSTRUMENT

RJTT / TOKYO INTL

RNAV STAR RWY34R/34L

AKSEL 2C ARRIVAL

From AKSEL, to CLONE, to TT460, to TT461, to CIVIC at 7000FT, to TT462, to TT463, to TT464, to EPSON at 7000FT, to CREAM.

Critical DME	-
DME GAP	-
Inappropriate Nav aids	See AD1.1.6.10.3. Inappropriate NAVAIDs for RNAV1

Serial Number	Path Descriptor	Waypoint Identifier	Fly Over	Course °M(°T)	Magnetic Variation	Distance (NM)	Turn Direction	Altitude (FT)	Speed (KIAS)	Vertical Angle	Navigation Specification
001	IF	AKSEL	-	-	-7.5	-	-	-	-	-	RNAV1
002	TF	CLONE	-	085 (077.0)	-7.5	14.8	-	-	-	-	RNAV1
003	TF	TT460	-	068 (060.7)	-7.5	10.1	-	-	-	-	RNAV1
004	TF	TT461	-	044 (036.1)	-7.5	14.4	-	-	-	-	RNAV1
005	TF	CIVIC	-	345 (337.7)	-7.5	8.8	-	7000	210	-	RNAV1
006	TF	TT462	-	345 (337.7)	-7.5	6.4	-	-	-	-	RNAV1
007	TF	TT463	-	006 (358.0)	-7.5	6.9	-	-	-	-	RNAV1
008	TF	TT464	-	341 (333.5)	-7.5	5.4	-	-	-	-	RNAV1
009	TF	EPSON	-	317 (309.0)	-7.5	6.9	-	7000	210	-	RNAV1
010	TF	CREAM	-	211 (203.6)	-7.5	14.1	-	-	-	-	RNAV1

Path	Waypoint Identifier	Inbound Course °M(°T)	Magnetic Variation	Outbound Time (MIN)	Outbound Distance (NM)	Turn Direction	Minimum Altitude (FT)	Maximum Altitude (FT)	Speed (KIAS)	Navigation Specification
Hold	AKSEL	039 (031.2)	-7.5	1.0(-14000) 1.5(+14001)	-	R	5000	-	-230(-14000) -240(+14001)	RNAV1
Hold	CIVIC	345 (337.7)	-7.5	1.0(-14000) 1.5(+14001)	-	R	4000	-	-230(-14000) -240(+14001)	RNAV1
Hold	CREAM	291 (283.1)	-7.5	1.0(-14000) 1.5(+14001)	-	R	4000	-	-230(-14000) -240(+14001)	RNAV1

Waypoint Coordinates

Waypoint Identifier	Coordinates	Waypoint Identifier	Coordinates
AKSEL	344039.5N / 1395126.9E	TT456	345329.3N / 1401440.2E
ARLON	351525.3N / 1395859.8E	TT460	344852.6N / 1401936.8E
CIVIC	350840.6N / 1402552.1E	TT461	350030.2N / 1402957.9E
CLONE	344357.8N / 1400856.0E	TT462	351433.3N / 1402254.8E
CREAM	351743.4N / 1400612.4E	TT463	352125.4N / 1402237.1E
EPSON	353036.2N / 1401305.9E	TT464	352617.6N / 1401938.6E
KAIHO	351857.8N / 1394642.4E	UMUKI	351219.1N / 1394849.2E
TT454	344844.8N / 1395725.3E	WALLY	350120.1N / 1402138.6E
TT455	344946.2N / 1400635.3E	WEDGE	350900.4N / 1395846.5E

CHANGE : WALLY renamed

STANDARD ARRIVAL CHART-INSTRUMENT

RJTT / TOKYO INTL

RNAV STAR RWY34R/34L

OSHIMA 2H ARRIVAL / AKSEL 2H ARRIVAL  
AROSA 2H ARRIVAL

RNAV 1

Note 1) DME/DME/IRU or GNSS required.  
2) RADAR service required.

VAR 8° W(2019)

MAX 230KIAS(at or below FL140)  
MAX 240KIAS(above FL140)  
1MIN(at or below FL140)  
1.5MIN(above FL140)

MAX 230KIAS(at or below FL140)  
MAX 240KIAS(above FL140)  
1MIN(at or below FL140)  
1.5MIN(above FL140)

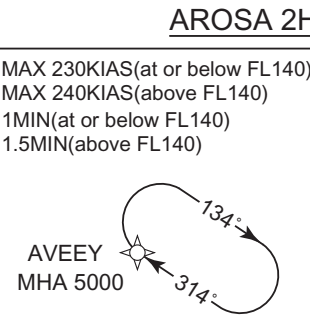
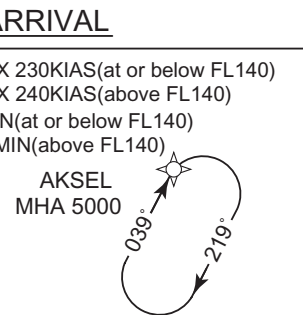
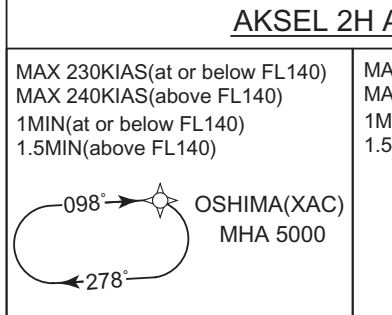
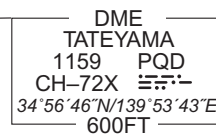
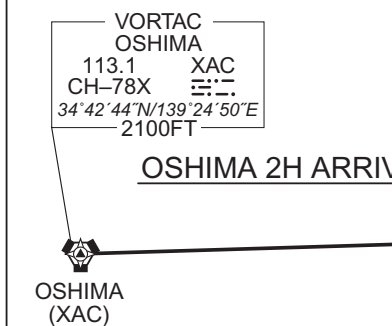
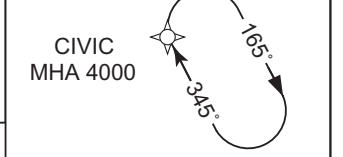
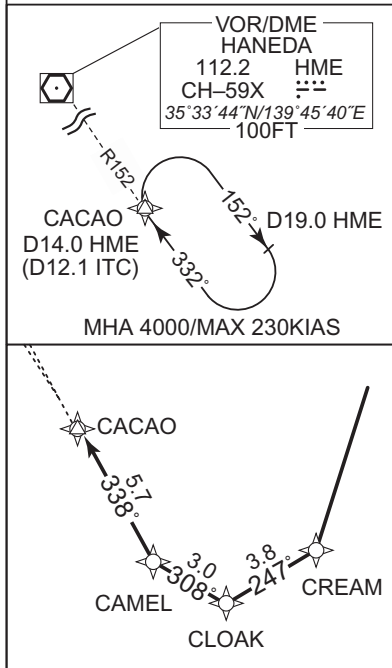

CHANGE : AVEEY renamed

MAX 230KIAS(at or below FL140)  
MAX 240KIAS(above FL140)  
1MIN(at or below FL140)  
1.5MIN(above FL140)

MAX 230KIAS(at or below FL140)  
MAX 240KIAS(above FL140)  
1MIN(at or below FL140)  
1.5MIN(above FL140)

MAX 230KIAS(at or below FL140)  
MAX 240KIAS(above FL140)  
1MIN(at or below FL140)  
1.5MIN(above FL140)

STANDARD ARRIVAL CHART-INSTRUMENT

RJTT / TOKYO INTL

RNAV STAR RWY34R/34L

OSHIMA 2H ARRIVAL

From XAC, to CLONE, to TT460, to TT461, to CIVIC at 7000FT, to TT462, to TT463, to TT464, to EPSON at 7000FT, to CREAM, to CLOAK, to CAMEL, to CACAO.

Note: When cleared HIGHWAY VISUAL RWY34R APPROACH, aircraft should fly via last routing cleared until CACAO.

Critical DME	-
DME GAP	-
Inappropriate Nav aids	See AD1.1.6.10.3. Inappropriate NAVAIDs for RNAV1

Serial Number	Path Descriptor	Waypoint Identifier	Fly Over	Course °M(°T)	Magnetic Variation	Distance (NM)	Turn Direction	Altitude (FT)	Speed (KIAS)	Vertical Angle	Navigation Specification
001	IF	XAC	-	-	-7.5	-	-	-	-	-	RNAV1
002	TF	CLONE	-	095 (087.8)	-7.5	36.3	-	-	-	-	RNAV1
003	TF	TT460	-	068 (060.7)	-7.5	10.1	-	-	-	-	RNAV1
004	TF	TT461	-	044 (036.1)	-7.5	14.4	-	-	-	-	RNAV1
005	TF	CIVIC	-	345 (337.7)	-7.5	8.8	-	7000	210	-	RNAV1
006	TF	TT462	-	345 (337.7)	-7.5	6.4	-	-	-	-	RNAV1
007	TF	TT463	-	006 (358.0)	-7.5	6.9	-	-	-	-	RNAV1
008	TF	TT464	-	341 (333.5)	-7.5	5.4	-	-	-	-	RNAV1
009	TF	EPSON	-	317 (309.0)	-7.5	6.9	-	7000	210	-	RNAV1
010	TF	CREAM	-	211 (203.6)	-7.5	14.1	-	-	-	-	RNAV1
011	TF	CLOAK	-	247 (240.0)	-7.5	3.8	-	-	-	-	RNAV1
012	TF	CAMEL	-	308 (300.1)	-7.5	3.0	-	-	-	-	RNAV1
013	TF	CACAO	-	338 (330.1)	-7.5	5.7	-	-	-	-	RNAV1

Path	Waypoint Identifier	Inbound Course °M(°T)	Magnetic Variation	Outbound Time (MIN)	Outbound Distance (NM)	Turn Direction	Minimum Altitude (FT)	Maximum Altitude (FT)	Speed (KIAS)	Navigation Specification
Hold	XAC	098 (090.3)	-7.5	1.0(-14000) 1.5(+14001)	-	R	5000	-	-230(-14000) -240(+14001)	RNAV1
Hold	CIVIC	345 (337.7)	-7.5	1.0(-14000) 1.5(+14001)	-	R	4000	-	-230(-14000) -240(+14001)	RNAV1
Hold	CREAM	291 (283.1)	-7.5	1.0(-14000) 1.5(+14001)	-	R	4000	-	-230(-14000) -240(+14001)	RNAV1

CHANGE : Note added.



STANDARD ARRIVAL CHART-INSTRUMENT

RJTT / TOKYO INTL

RNAV STAR RWY34R/34L

AKSEL 2H ARRIVAL

From AKSEL, to CLONE, to TT460, to TT461, to CIVIC at 7000FT, to TT462, to TT463, to TT464, to EPSON at 7000FT, to CREAM, to CLOAK, to CAMEL, to CACAO.

Note: When cleared HIGHWAY VISUAL RWY34R APPROACH, aircraft should fly via last routing cleared until CACAO.

Critical DME	-
DME GAP	-
Inappropriate Nav aids	See AD1.1.6.10.3. Inappropriate NAVAIDs for RNAV1

Serial Number	Path Descriptor	Waypoint Identifier	Fly Over	Course °M(°T)	Magnetic Variation	Distance (NM)	Turn Direction	Altitude (FT)	Speed (KIAS)	Vertical Angle	Navigation Specification
001	IF	AKSEL	-	-	-7.5	-	-	-	-	-	RNAV1
002	TF	CLONE	-	085 (077.0)	-7.5	14.8	-	-	-	-	RNAV1
003	TF	TT460	-	068 (060.7)	-7.5	10.1	-	-	-	-	RNAV1
004	TF	TT461	-	044 (036.1)	-7.5	14.4	-	-	-	-	RNAV1
005	TF	CIVIC	-	345 (337.7)	-7.5	8.8	-	7000	210	-	RNAV1
006	TF	TT462	-	345 (337.7)	-7.5	6.4	-	-	-	-	RNAV1
007	TF	TT463	-	006 (358.0)	-7.5	6.9	-	-	-	-	RNAV1
008	TF	TT464	-	341 (333.5)	-7.5	5.4	-	-	-	-	RNAV1
009	TF	EPSON	-	317 (309.0)	-7.5	6.9	-	7000	210	-	RNAV1
010	TF	CREAM	-	211 (203.6)	-7.5	14.1	-	-	-	-	RNAV1
011	TF	CLOAK	-	247 (240.0)	-7.5	3.8	-	-	-	-	RNAV1
012	TF	CAMEL	-	308 (300.1)	-7.5	3.0	-	-	-	-	RNAV1
013	TF	CACAO	-	338 (330.1)	-7.5	5.7	-	-	-	-	RNAV1

Path	Waypoint Identifier	Inbound Course °M(°T)	Magnetic Variation	Outbound Time (MIN)	Outbound Distance (NM)	Turn Direction	Minimum Altitude (FT)	Maximum Altitude (FT)	Speed (KIAS)	Navigation Specification
Hold	AKSEL	039 (031.2)	-7.5	1.0(-14000) 1.5(+14001)	-	R	5000	-	-230(-14000) -240(+14001)	RNAV1
Hold	CIVIC	345 (337.7)	-7.5	1.0(-14000) 1.5(+14001)	-	R	4000	-	-230(-14000) -240(+14001)	RNAV1
Hold	CREAM	291 (283.1)	-7.5	1.0(-14000) 1.5(+14001)	-	R	4000	-	-230(-14000) -240(+14001)	RNAV1

CHANGE : Note added.



STANDARD ARRIVAL CHART-INSTRUMENT

RJTT / TOKYO INTL

RNAV STAR RWY34R/34L

AROSA 2H ARRIVAL

From AROSA, to AVEEY at 11000FT, to TT460, to TT461, to CIVIC at 7000FT, to TT462, to TT463, toTT464, to EPSON at 7000FT, to CREAM, to CLOAK, to CAMEL, to CACAO.

Note: When cleared HIGHWAY VISUAL RWY34R APPROACH, aircraft should fly via last routing cleared until CACAO.

Critical DME	-
DME GAP	-
Inappropriate Navaids	See AD1.1.6.10.3. Inappropriate NAVAIDs for RNAV1

Serial Number	Path Descriptor	Waypoint Identifier	Fly Over	Course °M(°T)	Magnetic Variation	Distance (NM)	Turn Direction	Altitude (FT)	Speed (KIAS)	Vertical Angle	Navigation Specification
001	IF	AROSA	-	-	-7.5	-	-	-	-	-	RNAV1
002	TF	AVEEY	-	277 (269.8)	-7.5	16.4	-	11000	230	-	RNAV1
003	TF	TT460	-	352 (344.5)	-7.5	7.2	-	-	-	-	RNAV1
004	TF	TT461	-	044 (036.1)	-7.5	14.4	-	-	-	-	RNAV1
005	TF	CIVIC	-	345 (337.7)	-7.5	8.8	-	7000	210	-	RNAV1
006	TF	TT462	-	345 (337.7)	-7.5	6.4	-	-	-	-	RNAV1
007	TF	TT463	-	006 (358.0)	-7.5	6.9	-	-	-	-	RNAV1
008	TF	TT464	-	341 (333.5)	-7.5	5.4	-	-	-	-	RNAV1
009	TF	EPSON	-	317 (309.0)	-7.5	6.9	-	7000	210	-	RNAV1
010	TF	CREAM	-	211 (203.6)	-7.5	14.1	-	-	-	-	RNAV1
011	TF	CLOAK	-	247 (240.0)	-7.5	3.8	-	-	-	-	RNAV1
012	TF	CAMEL	-	308 (300.1)	-7.5	3.0	-	-	-	-	RNAV1
013	TF	CACAO	-	338 (330.1)	-7.5	5.7	-	-	-	-	RNAV1

Path	Waypoint Identifier	Inbound Course °M(°T)	Magnetic Variation	Outbound Time (MIN)	Outbound Distance (NM)	Turn Direction	Minimum Altitude (FT)	Maximum Altitude (FT)	Speed (KIAS)	Navigation Specification
Hold	AVEEY	314 (306.1)	-7.5	1.0(-14000) 1.5(+14001)	-	R	5000	-	-230(-14000) -240(+14001)	RNAV1
Hold	CIVIC	345 (337.7)	-7.5	1.0(-14000) 1.5(+14001)	-	R	4000	-	-230(-14000) -240(+14001)	RNAV1
Hold	CREAM	291 (283.1)	-7.5	1.0(-14000) 1.5(+14001)	-	R	4000	-	-230(-14000) -240(+14001)	RNAV1

CHANGE : Note added.

STANDARD ARRIVAL CHART-INSTRUMENT

RJTT / TOKYO INTL

RNAV STAR RWY34R/34L

Waypoint Coordinates

Waypoint Identifier	Coordinates	Waypoint Identifier	Coordinates
AKSEL	344039.5N / 1395126.9E	CREAM	351743.4N / 1400612.4E
AROSA	344201.7N / 1404157.3E	EPSON	353036.2N / 1401305.9E
AVEEY	344155.9N / 1402158.0E	TT460	344852.6N / 1401936.8E
CACAO	352212.8N / 1395530.1E	TT461	350030.2N / 1402957.9E
CAMEL	351718.2N / 1395857.8E	TT462	351433.3N / 1402254.8E
CIVIC	350840.6N / 1402552.1E	TT463	352125.4N / 1402237.1E
CLOAK	351548.0N / 1400208.2E	TT464	352617.6N / 1401938.6E
CLONE	344357.8N / 1400856.0E	XAC	344244.1N / 1392450.5E

CHANGE : AVEEY renamed

**INTENTIONALLY LEFT BLANK**

STANDARD ARRIVAL CHART-INSTRUMENT

RJTT / TOKYO INTL

RNAV STAR RWY34R/34L

GODIN 1H ARRIVAL  
POLIX 1H ARRIVAL

RNAV 1

Note 1) DME/DME/IRU or GNSS required.  
2) RADAR service required.

VAR 8° W(2019)

GODIN 1H ARRIVAL

MAX 230KIAS(at or below FL140)  
MAX 240KIAS(above FL140)  
1MIN(at or below FL140)  
1.5MIN(above FL140)



POLIX 1H ARRIVAL

MAX 230KIAS(at or below FL140)  
MAX 240KIAS(above FL140)  
1MIN(at or below FL140)  
1.5MIN(above FL140)

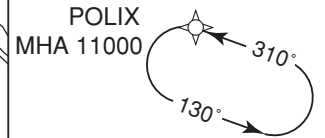

MAX 230KIAS(at or below FL140)  
MAX 240KIAS(above FL140)  
1MIN(at or below FL140)  
1.5MIN(above FL140)



MAX 230KIAS(at or below FL140)  
MAX 240KIAS(above FL140)  
1MIN(at or below FL140)  
1.5MIN(above FL140)

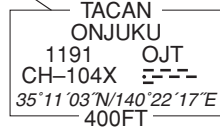
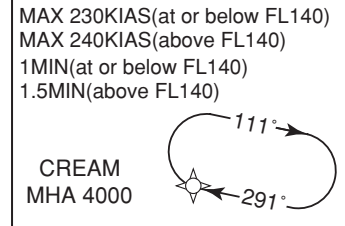
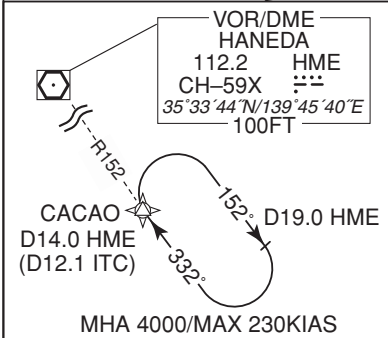
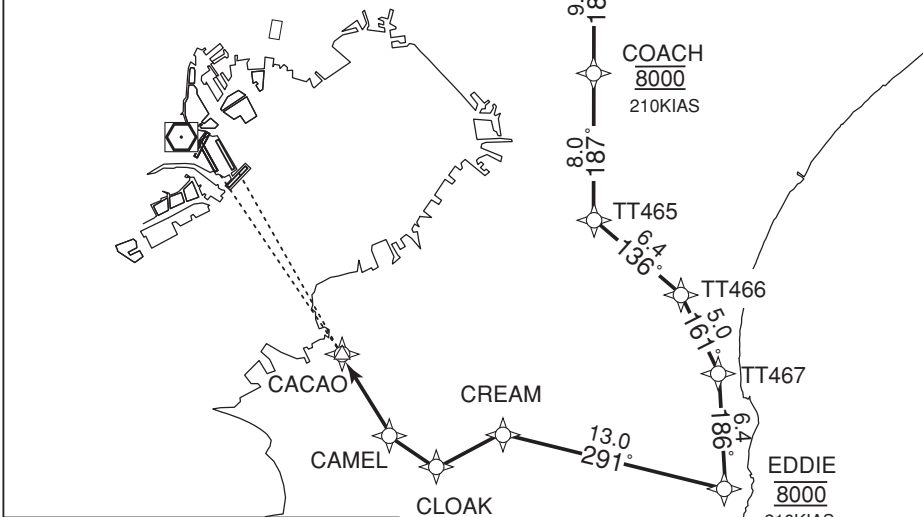
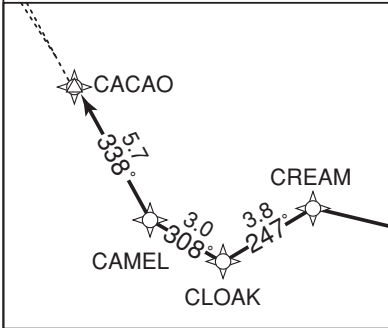

CHANGE : New PROC

STANDARD ARRIVAL CHART-INSTRUMENT

RJTT / TOKYO INTL

RNAV STAR RWY34R/34L

GODIN 1H ARRIVAL

From GODIN, to CHIPS at or below 13000FT, to COLOR at or below 11000FT, to COPSE, to COACH at 8000FT, to TT465, to TT466, to TT467, to EDDIE at 8000FT, to CREAM, to CLOAK, to CAMEL, to CACAO.

Note: When cleared HIGHWAY VISUAL RWY34R APPROACH, aircraft should fly via last routing cleared until CACAO.

Critical DME	-
DME GAP	-
Inappropriate Nav aids	See AD1.1.6.10.3. Inappropriate NAVAIDs for RNAV1

Serial Number	Path Descriptor	Waypoint Identifier	Fly Over	Course °M(°T)	Magnetic Variation	Distance (NM)	Turn Direction	Altitude (FT)	Speed (KIAS)	Vertical Angle	Navigation Specification
001	IF	GODIN	-	-	-7.5	-	-	-	-	-	RNAV1
002	TF	CHIPS	-	197 (189.1)	-7.5	11.8	-	-13000	-	-	RNAV1
003	TF	COLOR	-	197 (189.1)	-7.5	11.7	-	-11000	-	-	RNAV1
004	TF	COPSE	-	188 (180.8)	-7.5	14.3	-	-	-	-	RNAV1
005	TF	COACH	-	185 (177.8)	-7.5	9.4	-	8000	210	-	RNAV1
006	TF	TT465	-	187 (179.6)	-7.5	8.0	-	-	-	-	RNAV1
007	TF	TT466	-	136 (128.9)	-7.5	6.4	-	-	-	-	RNAV1
008	TF	TT467	-	161 (153.5)	-7.5	5.0	-	-	-	-	RNAV1
009	TF	EDDIE	-	186 (178.0)	-7.5	6.4	-	8000	210	-	RNAV1
010	TF	CREAM	-	291 (283.1)	-7.5	13.0	-	-	-	-	RNAV1
011	TF	CLOAK	-	247 (240.0)	-7.5	3.8	-	-	-	-	RNAV1
012	TF	CAMEL	-	308 (300.1)	-7.5	3.0	-	-	-	-	RNAV1
013	TF	CACAO	-	338 (330.1)	-7.5	5.7	-	-	-	-	RNAV1

Path	Waypoint Identifier	Inbound Course °M(°T)	Magnetic Variation	Outbound Time (MIN)	Outbound Distance (NM)	Turn Direction	Minimum Altitude (FT)	Maximum Altitude (FT)	Speed (KIAS)	Navigation Specification
Hold	GODIN	197 (189.2)	-7.5	1.0(-14000) 1.5(+14001)	-	R	8000	-	-230(-14000) -240(+14001)	RNAV1
Hold	COLOR	197 (189.1)	-7.5	1.0(-14000) 1.5(+14001)	-	R	8000	-	-230(-14000) -240(+14001)	RNAV1
Hold	COACH	185 (177.8)	-7.5	1.0(-14000) 1.5(+14001)	-	R	4000	-	-230(-14000) -240(+14001)	RNAV1
Hold	CREAM	291 (283.1)	-7.5	1.0(-14000) 1.5(+14001)	-	R	4000	-	-230(-14000) -240(+14001)	RNAV1

CHANGE : Note added.

STANDARD ARRIVAL CHART-INSTRUMENT

RJTT / TOKYO INTL

RNAV STAR RWY34R/34L

POLIX 1H ARRIVAL

From POLIX at FL150, to CHIPS at or below 13000FT, to COLOR at or below 11000FT, to COPSE, to COACH at 8000FT, to TT465, to TT466, to TT467, to EDDIE at 8000FT, to CREAM, to CLOAK, to CAMEL, to CACAO.

Note: When cleared HIGHWAY VISUAL RWY34R APPROACH, aircraft should fly via last routing cleared until CACAO.

Critical DME	-
DME GAP	-
Inappropriate Navaids	See AD1.1.6.10.3. Inappropriate NAVAIDs for RNAV1

Serial Number	Path Descriptor	Waypoint Identifier	Fly Over	Course °M(°T)	Magnetic Variation	Distance (NM)	Turn Direction	Altitude (FT)	Speed (KIAS)	Vertical Angle	Navigation Specification
001	IF	POLIX	-	-	-7.5	-	-	FL150	-	-	RNAV1
002	TF	CHIPS	-	279 (271.1)	-7.5	9.5	-	-13000	-	-	RNAV1
003	TF	COLOR	-	197 (189.1)	-7.5	11.7	-	-11000	-	-	RNAV1
004	TF	COPSE	-	188 (180.8)	-7.5	14.3	-	-	-	-	RNAV1
005	TF	COACH	-	185 (177.8)	-7.5	9.4	-	8000	210	-	RNAV1
006	TF	TT465	-	187 (179.6)	-7.5	8.0	-	-	-	-	RNAV1
007	TF	TT466	-	136 (128.9)	-7.5	6.4	-	-	-	-	RNAV1
008	TF	TT467	-	161 (153.5)	-7.5	5.0	-	-	-	-	RNAV1
009	TF	EDDIE	-	186 (178.0)	-7.5	6.4	-	8000	210	-	RNAV1
010	TF	CREAM	-	291 (283.1)	-7.5	13.0	-	-	-	-	RNAV1
011	TF	CLOAK	-	247 (240.0)	-7.5	3.8	-	-	-	-	RNAV1
012	TF	CAMEL	-	308 (300.1)	-7.5	3.0	-	-	-	-	RNAV1
013	TF	CACAO	-	338 (330.1)	-7.5	5.7	-	-	-	-	RNAV1

Path	Waypoint Identifier	Inbound Course °M(°T)	Magnetic Variation	Outbound Time (MIN)	Outbound Distance (NM)	Turn Direction	Minimum Altitude (FT)	Maximum Altitude (FT)	Speed (KIAS)	Navigation Specification
Hold	POLIX	310 (302.3)	-7.5	1.0(-14000) 1.5(+14001)	-	L	11000	-	-230(-14000) -240(+14001)	RNAV1
Hold	COLOR	197 (189.1)	-7.5	1.0(-14000) 1.5(+14001)	-	R	8000	-	-230(-14000) -240(+14001)	RNAV1
Hold	COACH	185 (177.8)	-7.5	1.0(-14000) 1.5(+14001)	-	R	4000	-	-230(-14000) -240(+14001)	RNAV1
Hold	CREAM	291 (283.1)	-7.5	1.0(-14000) 1.5(+14001)	-	R	4000	-	-230(-14000) -240(+14001)	RNAV1

CHANGE : Note added.

## STANDARD ARRIVAL CHART-INSTRUMENT

RJTT / TOKYO INTL

RNAV STAR RWY34R/34L

Waypoint Coordinates

Waypoint Identifier	Coordinates	Waypoint Identifier	Coordinates
CACAO	352212.8N / 1395530.1E	CREAM	351743.4N / 1400612.4E
CAMEL	351718.2N / 1395857.8E	EDDIE	351447.4N / 1402140.9E
CHIPS	361247.7N / 1401436.9E	GODIN	362425.3N / 1401655.9E
CLOAK	351548.0N / 1400208.2E	POLIX	361237.1N / 1402622.5E
COACH	353736.0N / 1401231.5E	TT465	352939.2N / 1401235.4E
COLOR	360116.3N / 1401219.8E	TT466	352539.0N / 1401840.1E
COPSE	354658.8N / 1401205.4E	TT467	352110.2N / 1402124.4E

CHANGE : New PROC

TAXIING GUIDE LINE AND PARKING AREAS

**HS3** Runway holding position markings are installed. ATC authorization shall be required for crossing the runway.

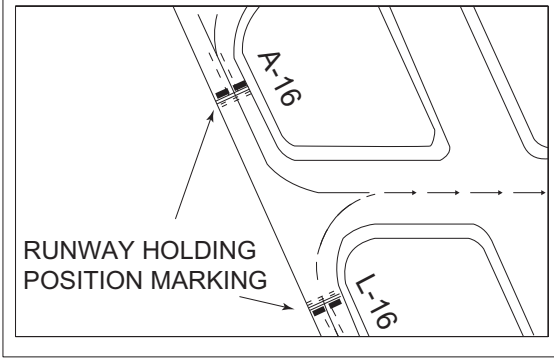

CHANGE: TWY CL marking for B(INT of W) added.

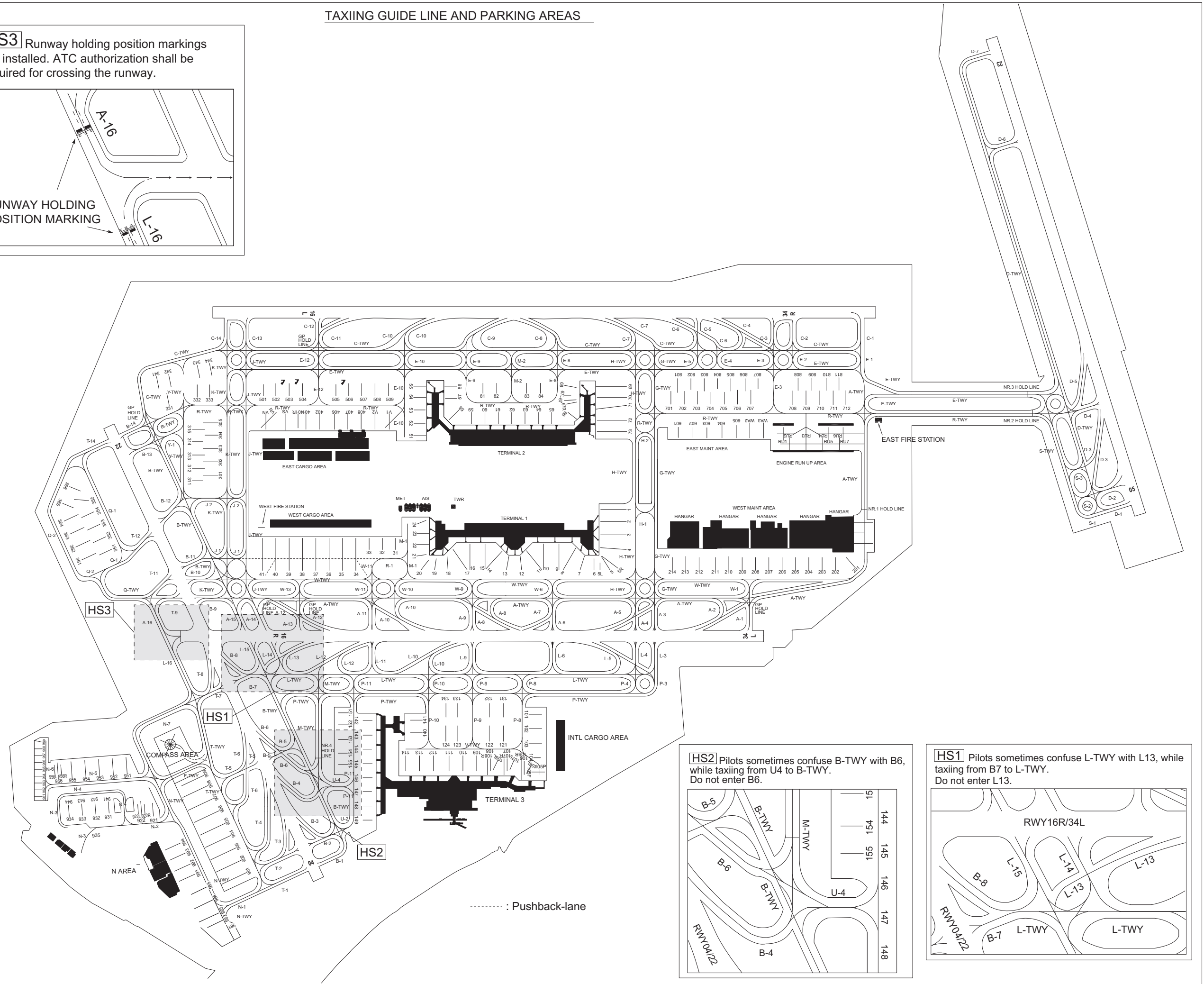

**HS2** Pilots sometimes confuse B-TWY with B6, while taxiing from U4 to B-TWY. Do not enter B6.

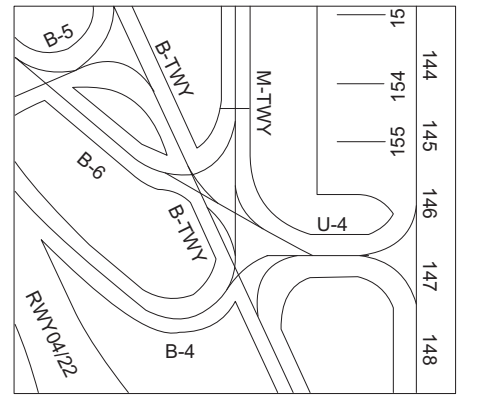

**HS1** Pilots sometimes confuse L-TWY with L13, while taxiing from B7 to L-TWY. Do not enter L13.

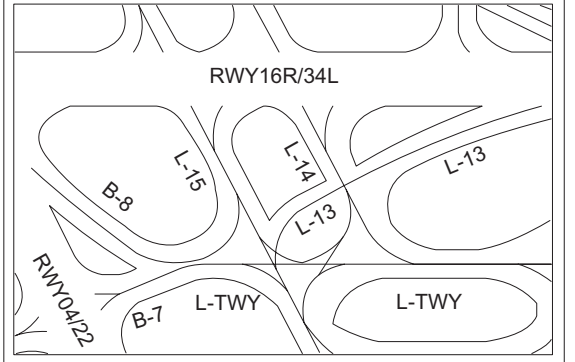



STANDARD ARRIVAL CHART-INSTRUMENT

RJTT / TOKYO INTL

RNAV STAR RWY22/23

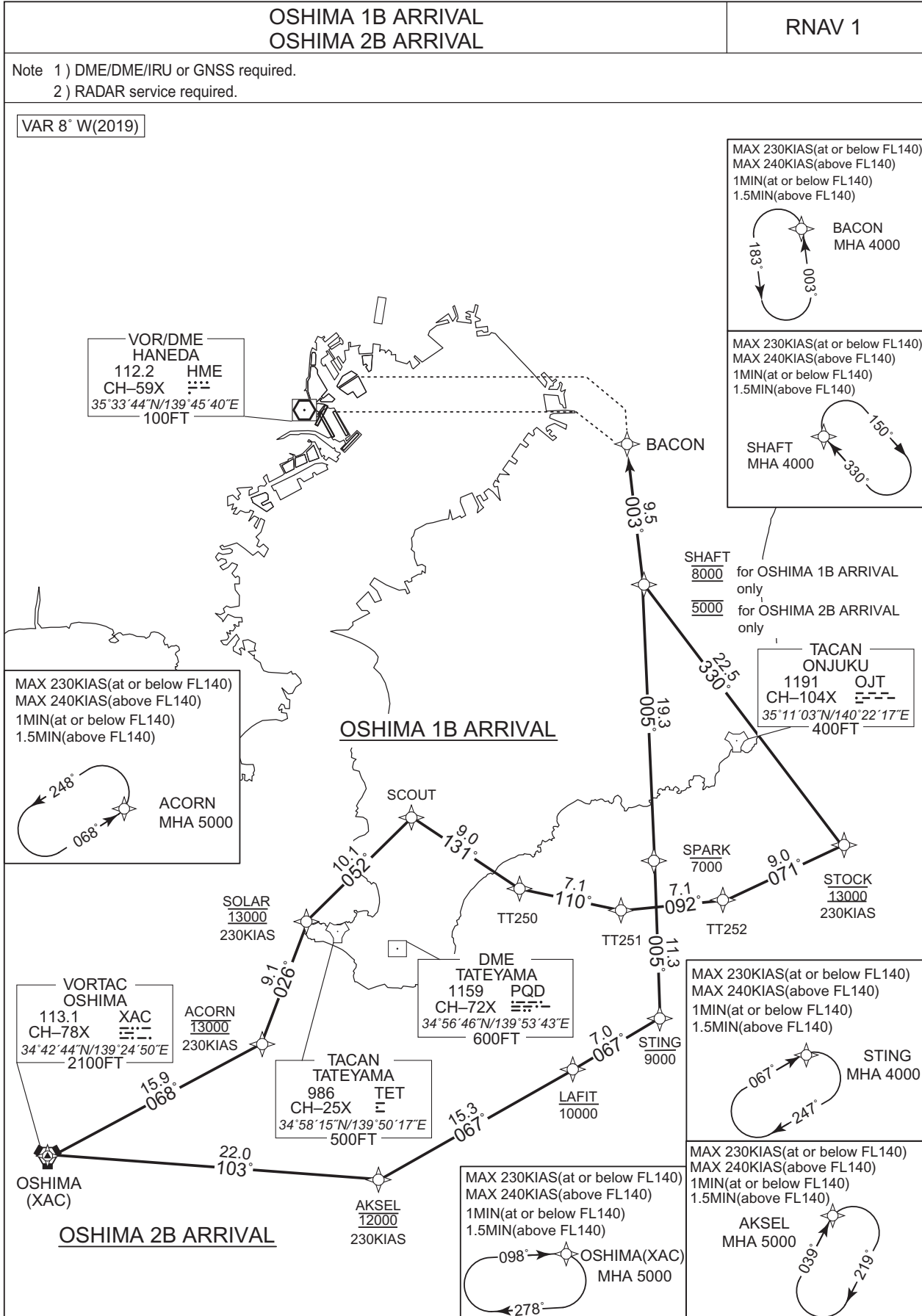

CHANGE : SOLAR renamed

STANDARD ARRIVAL CHART-INSTRUMENT

RJTT / TOKYO INTL

RNAV STAR RWY22/23

OSHIMA 1B ARRIVAL

From XAC, to ACORN at 13000FT, to SOLAR at 13000FT, to SCOUT, to TT250, to TT251, to TT252, to STOCK at 13000FT, to SHAFT at 8000FT, to BACON.

Critical DME	-
DME GAP	-
Inappropriate Nav aids	See AD1.1.6.10.3. Inappropriate NAVAIDS for RNAV1

Serial Number	Path Descriptor	Waypoint Identifier	Fly Over	Course °M(°T)	Magnetic Variation	Distance (NM)	Turn Direction	Altitude (FT)	Speed (KIAS)	Vertical Angle	Navigation Specification
001	IF	XAC	-	-	-7.5	-	-	-	-	-	RNAV1
002	TF	ACORN	-	068 (060.8)	-7.5	15.9	-	13000	230	-	RNAV1
003	TF	SOLAR	-	026 (018.4)	-7.5	9.1	-	13000	230	-	RNAV1
004	TF	SCOUT	-	052 (044.3)	-7.5	10.1	-	-	-	-	RNAV1
005	TF	TT250	-	131 (123.1)	-7.5	9.0	-	-	-	-	RNAV1
006	TF	TT251	-	110 (102.5)	-7.5	7.1	-	-	-	-	RNAV1
007	TF	TT252	-	092 (084.3)	-7.5	7.1	-	-	-	-	RNAV1
008	TF	STOCK	-	071 (063.6)	-7.5	9.0	-	13000	230	-	RNAV1
009	TF	SHAFT	-	330 (322.4)	-7.5	22.5	-	8000	-	-	RNAV1
010	TF	BACON	-	003 (355.2)	-7.5	9.5	-	-	-	-	RNAV1

Path	Waypoint Identifier	Inbound Course °M(°T)	Magnetic Variation	Outbound Time (MIN)	Outbound Distance (NM)	Turn Direction	Minimum Altitude (FT)	Maximum Altitude (FT)	Speed (KIAS)	Navigation Specification
Hold	XAC	098 (090.3)	-7.5	1.0(-14000) 1.5(+14001)	-	R	5000	-	-230(-14000) -240(+14001)	RNAV1
Hold	ACORN	068 (060.8)	-7.5	1.0(-14000) 1.5(+14001)	-	L	5000	-	-230(-14000) -240(+14001)	RNAV1
Hold	SHAFT	330 (322.4)	-7.5	1.0(-14000) 1.5(+14001)	-	R	4000	-	-230(-14000) -240(+14001)	RNAV1
Hold	BACON	003 (355.2)	-7.5	1.0(-14000) 1.5(+14001)	-	L	4000	-	-230(-14000) -240(+14001)	RNAV1

CHANGE : SOLAR renamed

STANDARD ARRIVAL CHART-INSTRUMENT

RJTT / TOKYO INTL

RNAV STAR RWY22/23

OSHIMA 2B ARRIVAL

From XAC, to AKSEL at 12000FT, to LAFIT at or below 10000FT, to STING at or below 9000FT, to SPARK at or below 7000FT, to SHAFT at 5000FT, to BACON.

Critical DME	-
DME GAP	-
Inappropriate Nav aids	See AD1.1.6.10.3. Inappropriate NAVAIDs for RNAV1

Serial Number	Path Descriptor	Waypoint Identifier	Fly Over	Course °M(°T)	Magnetic Variation	Distance (NM)	Turn Direction	Altitude (FT)	Speed (KIAS)	Vertical Angle	Navigation Specification
001	IF	XAC	-	-	-7.5	-	-	-	-	-	RNAV1
002	TF	AKSEL	-	103 (095.3)	-7.5	22.0	-	12000	230	-	RNAV1
003	TF	LAFIT	-	067 (059.5)	-7.5	15.3	-	-10000	-	-	RNAV1
004	TF	STING	-	067 (059.6)	-7.5	7.0	-	-9000	-	-	RNAV1
005	TF	SPARK	-	005 (357.4)	-7.5	11.3	-	-7000	-	-	RNAV1
006	TF	SHAFT	-	005 (357.4)	-7.5	19.3	-	5000	-	-	RNAV1
007	TF	BACON	-	003 (355.2)	-7.5	9.5	-	-	-	-	RNAV1

Path	Waypoint Identifier	Inbound Course °M(°T)	Magnetic Variation	Outbound Time (MIN)	Outbound Distance (NM)	Turn Direction	Minimum Altitude (FT)	Maximum Altitude (FT)	Speed (KIAS)	Navigation Specification
Hold	XAC	098 (090.3)	-7.5	1.0(-14000) 1.5(+14001)	-	R	5000	-	-230(-14000) -240(+14001)	RNAV1
Hold	AKSEL	039 (031.2)	-7.5	1.0(-14000) 1.5(+14001)	-	R	5000	-	-230(-14000) -240(+14001)	RNAV1
Hold	STING	067 (059.6)	-7.5	1.0(-14000) 1.5(+14001)	-	R	4000	-	-230(-14000) -240(+14001)	RNAV1
Hold	SHAFT	330 (322.4)	-7.5	1.0(-14000) 1.5(+14001)	-	R	4000	-	-230(-14000) -240(+14001)	RNAV1
Hold	BACON	003 (355.2)	-7.5	1.0(-14000) 1.5(+14001)	-	L	4000	-	-230(-14000) -240(+14001)	RNAV1

Waypoint Coordinates

Waypoint Identifier	Coordinates	Waypoint Identifier	Coordinates
ACORN	345028.8N / 1394146.7E	SPARK	350312.0N / 1401416.7E
AKSEL	344039.5N / 1395126.9E	STOCK	350438.7N / 1403002.9E
BACON	353155.0N / 1401215.1E	STING	345157.9N / 1401453.4E
LAFIT	344826.0N / 1400732.4E	TT250	350129.7N / 1400308.5E
SCOUT	350624.1N / 1395356.8E	TT251	345957.7N / 1401136.0E
SHAFT	352227.4N / 1401313.3E	TT252	350039.9N / 1402013.0E
SOLAR	345909.2N / 1394518.5E	XAC	344244.1N / 1392450.5E

CHANGE : SOLAR renamed

STANDARD ARRIVAL CHART-INSTRUMENT

RJTT / TOKYO INTL

RNAV STAR RWY22/23

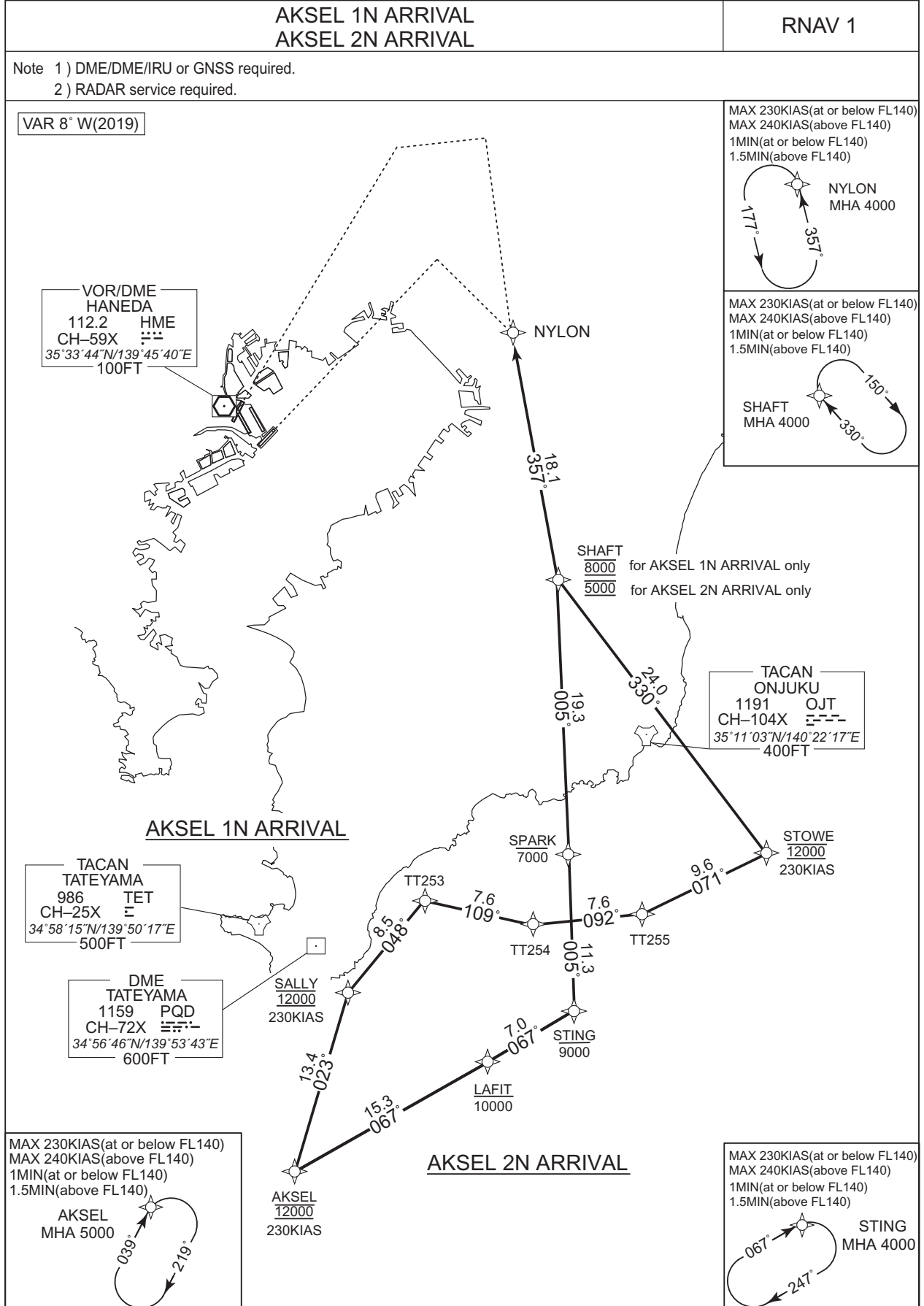

CHANGE : STOWE renamed

STANDARD ARRIVAL CHART-INSTRUMENT

RJTT / TOKYO INTL

RNAV STAR RWY22/23

AKSEL 1N ARRIVAL

From AKSEL at 12000FT, to SALLY at 12000FT, to TT253, to TT254, to TT255, to STOWE at 12000FT, to SHAFT at 8000FT, to NYLON.

Critical DME	-
DME GAP	-
Inappropriate Nav aids	See AD1.1.6.10.3. Inappropriate NAVAIDs for RNAV1

Serial Number	Path Descriptor	Waypoint Identifier	Fly Over	Course °M(°T)	Magnetic Variation	Distance (NM)	Turn Direction	Altitude (FT)	Speed (KIAS)	Vertical Angle	Navigation Specification
001	IF	AKSEL	-	-	-7.5	-	-	12000	230	-	RNAV1
002	TF	SALLY	-	023 (015.0)	-7.5	13.4	-	12000	230	-	RNAV1
003	TF	TT253	-	048 (040.5)	-7.5	8.5	-	-	-	-	RNAV1
004	TF	TT254	-	109 (102.0)	-7.5	7.6	-	-	-	-	RNAV1
005	TF	TT255	-	092 (084.4)	-7.5	7.6	-	-	-	-	RNAV1
006	TF	STOWE	-	071 (063.6)	-7.5	9.6	-	12000	230	-	RNAV1
007	TF	SHAFT	-	330 (322.4)	-7.5	24.0	-	8000	-	-	RNAV1
008	TF	NYLON	-	357 (350.0)	-7.5	18.1	-	-	-	-	RNAV1

Path	Waypoint Identifier	Inbound Course °M(°T)	Magnetic Variation	Outbound Time (MIN)	Outbound Distance (NM)	Turn Direction	Minimum Altitude (FT)	Maximum Altitude (FT)	Speed (KIAS)	Navigation Specification
Hold	AKSEL	039 (031.2)	-7.5	1.0(-14000) 1.5(+14001)	-	R	5000	-	-230(-14000) -240(+14001)	RNAV1
Hold	SHAFT	330 (322.4)	-7.5	1.0(-14000) 1.5(+14001)	-	R	4000	-	-230(-14000) -240(+14001)	RNAV1
Hold	NYLON	357 (350.0)	-7.5	1.0(-14000) 1.5(+14001)	-	L	4000	-	-230(-14000) -240(+14001)	RNAV1

CHANGE : STOWE renamed

STANDARD ARRIVAL CHART-INSTRUMENT

RJTT / TOKYO INTL

RNAV STAR RWY22/23

AKSEL 2N ARRIVAL

From AKSEL at 12000FT, to LAFIT at or below 10000FT, to STING at or below 9000FT, to SPARK at or below 7000FT, to SHAFT at 5000FT, to NYLON.

Critical DME	-
DME GAP	-
Inappropriate Nav aids	See AD1.1.6.10.3. Inappropriate NAVAIDs for RNAV1

Serial Number	Path Descriptor	Waypoint Identifier	Fly Over	Course °M(°T)	Magnetic Variation	Distance (NM)	Turn Direction	Altitude (FT)	Speed (KIAS)	Vertical Angle	Navigation Specification
001	IF	AKSEL	-	-	-7.5	-	-	12000	230	-	RNAV1
002	TF	LAFIT	-	067 (059.5)	-7.5	15.3	-	-10000	-	-	RNAV1
003	TF	STING	-	067 (059.6)	-7.5	7.0	-	-9000	-	-	RNAV1
004	TF	SPARK	-	005 (357.4)	-7.5	11.3	-	-7000	-	-	RNAV1
005	TF	SHAFT	-	005 (357.4)	-7.5	19.3	-	5000	-	-	RNAV1
006	TF	NYLON	-	357 (350.0)	-7.5	18.1	-	-	-	-	RNAV1

Path	Waypoint Identifier	Inbound Course °M(°T)	Magnetic Variation	Outbound Time (MIN)	Outbound Distance (NM)	Turn Direction	Minimum Altitude (FT)	Maximum Altitude (FT)	Speed (KIAS)	Navigation Specification
Hold	AKSEL	039 (031.2)	-7.5	1.0(-14000) 1.5(+14001)	-	R	5000	-	-230(-14000) -240(+14001)	RNAV1
Hold	STING	067 (059.6)	-7.5	1.0(-14000) 1.5(+14001)	-	R	4000	-	-230(-14000) -240(+14001)	RNAV1
Hold	SHAFT	330 (322.4)	-7.5	1.0(-14000) 1.5(+14001)	-	R	4000	-	-230(-14000) -240(+14001)	RNAV1
Hold	NYLON	357 (350.0)	-7.5	1.0(-14000) 1.5(+14001)	-	L	4000	-	-230(-14000) -240(+14001)	RNAV1

Waypoint Coordinates

Waypoint Identifier	Coordinates	Waypoint Identifier	Coordinates
AKSEL	344039.5N / 1395126.9E	STING	345157.9N / 1401453.4E
LAFIT	344826.0N / 1400732.4E	STOWE	350325.9N / 1403111.4E
NYLON	354018.5N / 1400919.9E	TT253	350001.4N / 1400224.6E
SALLY	345333.9N / 1395540.1E	TT254	345826.5N / 1401129.4E
SHAFT	352227.4N / 1401313.3E	TT255	345910.9N / 1402041.4E
SPARK	350312.0N / 1401416.7E		

CHANGE : STOWE renamed

STANDARD ARRIVAL CHART-INSTRUMENT

RJTT / TOKYO INTL

RNAV STAR RWY34R/34L

POLIX 2A ARRIVAL / POLIX 2K ARRIVAL POLIX 1C ARRIVAL	RNAV 1
---	--------

Note 1) DME/DME/IRU or GNSS required.  
2) RADAR service required.

VAR 8° W(2019)

MAX 230KIAS(at or below FL140)  
MAX 240KIAS(above FL140)  
1MIN(at or below FL140)  
1.5MIN(above FL140)

KAIHO  
MHA 4000

MAX 230KIAS(at or below FL140)  
MAX 240KIAS(above FL140)  
1MIN(at or below FL140)  
1.5MIN(above FL140)

ARLON  
MHA 4000

MAX 230KIAS(at or below FL140)  
MAX 240KIAS(above FL140)  
1MIN(at or below FL140)  
1.5MIN(above FL140)

POLIX  
MHA 11000

MAX 230KIAS(at or below FL140)  
MAX 240KIAS(above FL140)  
1MIN(at or below FL140)  
1.5MIN(above FL140)

COLOR  
MHA 8000

MAX 230KIAS(at or below FL140)  
MAX 240KIAS(above FL140)  
1MIN(at or below FL140)  
1.5MIN(above FL140)

COACH  
MHA 4000

MAX 230KIAS(at or below FL140)  
MAX 240KIAS(above FL140)  
1MIN(at or below FL140)  
1.5MIN(above FL140)

CREAM  
MHA 4000

CHANGE : HOKUSO VOR/DME(HKE) abolished.

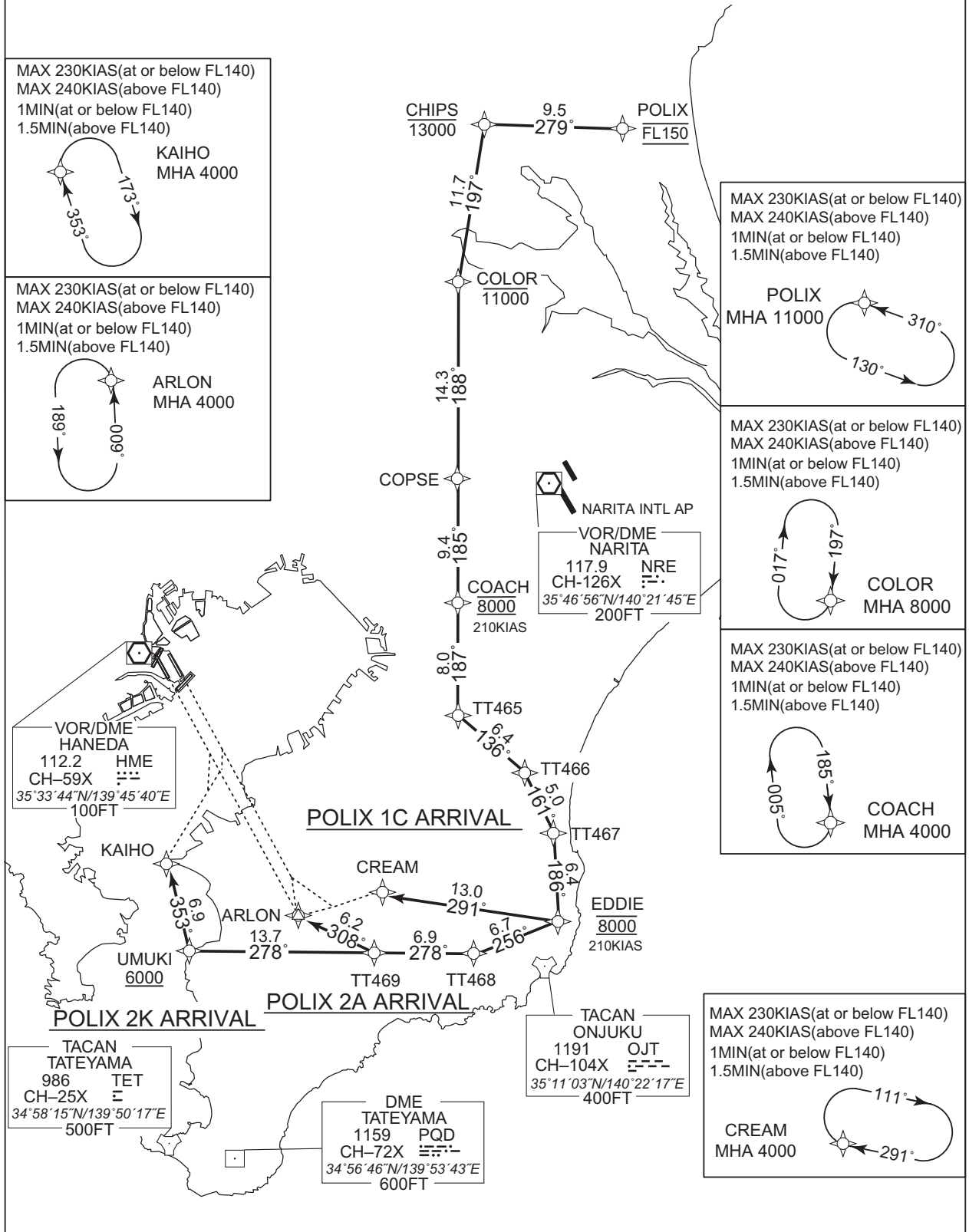



STANDARD ARRIVAL CHART-INSTRUMENT

RJTT / TOKYO INTL

RNAV STAR RWY34R/34L

POLIX 2A ARRIVAL

From POLIX at FL150, to CHIPS at or below 13000FT, to COLOR at or below 11000FT, to COPSE, to COACH at 8000FT, to TT465, to TT466, to TT467, to EDDIE at 8000FT, to TT468, to TT469, to ARLON.

Critical DME	-
DME GAP	-
Inappropriate Nav aids	See AD1.1.6.10.3. Inappropriate NAVAIDs for RNAV1

Serial Number	Path Descriptor	Waypoint Identifier	Fly Over	Course °M(°T)	Magnetic Variation	Distance (NM)	Turn Direction	Altitude (FT)	Speed (KIAS)	Vertical Angle	Navigation Specification
001	IF	POLIX	-	-	-7.5	-	-	FL150	-	-	RNAV1
002	TF	CHIPS	-	279 (271.1)	-7.5	9.5	-	-13000	-	-	RNAV1
003	TF	COLOR	-	197 (189.1)	-7.5	11.7	-	-11000	-	-	RNAV1
004	TF	COPSE	-	188 (180.8)	-7.5	14.3	-	-	-	-	RNAV1
005	TF	COACH	-	185 (177.8)	-7.5	9.4	-	8000	210	-	RNAV1
006	TF	TT465	-	187 (179.6)	-7.5	8.0	-	-	-	-	RNAV1
007	TF	TT466	-	136 (128.9)	-7.5	6.4	-	-	-	-	RNAV1
008	TF	TT467	-	161 (153.5)	-7.5	5.0	-	-	-	-	RNAV1
009	TF	EDDIE	-	186 (178.0)	-7.5	6.4	-	8000	210	-	RNAV1
010	TF	TT468	-	256 (248.1)	-7.5	6.7	-	-	-	-	RNAV1
011	TF	TT469	-	278 (270.2)	-7.5	6.9	-	-	-	-	RNAV1
012	TF	ARLON	-	308 (300.2)	-7.5	6.2	-	-	-	-	RNAV1

Path	Waypoint Identifier	Inbound Course °M(°T)	Magnetic Variation	Outbound Time (MIN)	Outbound Distance (NM)	Turn Direction	Minimum Altitude (FT)	Maximum Altitude (FT)	Speed (KIAS)	Navigation Specification
Hold	POLIX	310 (302.3)	-7.5	1.0(-14000) 1.5(+14001)	-	L	11000	-	-230(-14000) -240(+14001)	RNAV1
Hold	COLOR	197 (189.1)	-7.5	1.0(-14000) 1.5(+14001)	-	R	8000	-	-230(-14000) -240(+14001)	RNAV1
Hold	COACH	185 (177.8)	-7.5	1.0(-14000) 1.5(+14001)	-	R	4000	-	-230(-14000) -240(+14001)	RNAV1
Hold	ARLON	009 (001.6)	-7.5	1.0(-14000) 1.5(+14001)	-	L	4000	-	-230(-14000) -240(+14001)	RNAV1

CHANGE : New PROC



STANDARD ARRIVAL CHART-INSTRUMENT

RJTT / TOKYO INTL

RNAV STAR RWY34R/34L

POLIX 2K ARRIVAL

From POLIX at FL150, to CHIPS at or below 13000FT, to COLOR at or below 11000FT, to COPSE, to COACH at 8000FT, to TT465, to TT466, to TT467, to EDDIE at 8000FT, to TT468, to TT469, to UMUKI at or above 6000FT, to KAIHO.

Critical DME	-
DME GAP	-
Inappropriate NavAids	See AD1.1.6.10.3. Inappropriate NAVAIDs for RNAV1

Serial Number	Path Descriptor	Waypoint Identifier	Fly Over	Course °M(°T)	Magnetic Variation	Distance (NM)	Turn Direction	Altitude (FT)	Speed (KIAS)	Vertical Angle	Navigation Specification
001	IF	POLIX	-	-	-7.5	-	-	FL150	-	-	RNAV1
002	TF	CHIPS	-	279 (271.1)	-7.5	9.5	-	-13000	-	-	RNAV1
003	TF	COLOR	-	197 (189.1)	-7.5	11.7	-	-11000	-	-	RNAV1
004	TF	COPSE	-	188 (180.8)	-7.5	14.3	-	-	-	-	RNAV1
005	TF	COACH	-	185 (177.8)	-7.5	9.4	-	8000	210	-	RNAV1
006	TF	TT465	-	187 (179.6)	-7.5	8.0	-	-	-	-	RNAV1
007	TF	TT466	-	136 (128.9)	-7.5	6.4	-	-	-	-	RNAV1
008	TF	TT467	-	161 (153.5)	-7.5	5.0	-	-	-	-	RNAV1
009	TF	EDDIE	-	186 (178.0)	-7.5	6.4	-	8000	210	-	RNAV1
010	TF	TT468	-	256 (248.1)	-7.5	6.7	-	-	-	-	RNAV1
011	TF	TT469	-	278 (270.2)	-7.5	6.9	-	-	-	-	RNAV1
012	TF	UMUKI	-	278 (270.2)	-7.5	13.7	-	+6000	-	-	RNAV1
013	TF	KAIHO	-	353 (345.5)	-7.5	6.9	-	-	-	-	RNAV1

Path	Waypoint Identifier	Inbound Course °M(°T)	Magnetic Variation	Outbound Time (MIN)	Outbound Distance (NM)	Turn Direction	Minimum Altitude (FT)	Maximum Altitude (FT)	Speed (KIAS)	Navigation Specification
Hold	POLIX	310 (302.3)	-7.5	1.0(-14000) 1.5(+14001)	-	L	11000	-	-230(-14000) -240(+14001)	RNAV1
Hold	COLOR	197 (189.1)	-7.5	1.0(-14000) 1.5(+14001)	-	R	8000	-	-230(-14000) -240(+14001)	RNAV1
Hold	COACH	185 (177.8)	-7.5	1.0(-14000) 1.5(+14001)	-	R	4000	-	-230(-14000) -240(+14001)	RNAV1
Hold	KAIHO	353 (345.5)	-7.5	1.0(-14000) 1.5(+14001)	-	R	4000	-	-230(-14000) -240(+14001)	RNAV1

CHANGE : New PROC

STANDARD ARRIVAL CHART-INSTRUMENT

RJTT / TOKYO INTL

RNAV STAR RWY34R/34L

POLIX 1C ARRIVAL

From POLIX at FL150, to CHIPS at or below 13000FT, to COLOR at or below 11000FT, to COPSE, to COACH at 8000FT, to TT465, to TT466, to TT467, to EDDIE at 8000FT, to CREAM.

Critical DME	-
DME GAP	-
Inappropriate Nav aids	See AD1.1.6.10.3. Inappropriate NAVAIDs for RNAV1

Serial Number	Path Descriptor	Waypoint Identifier	Fly Over	Course °M(T)	Magnetic Variation	Distance (NM)	Turn Direction	Altitude (FT)	Speed (KIAS)	Vertical Angle	Navigation Specification
001	IF	POLIX	-	-	-7.5	-	-	FL150	-	-	RNAV1
002	TF	CHIPS	-	279 (271.1)	-7.5	9.5	-	-13000	-	-	RNAV1
003	TF	COLOR	-	197 (189.1)	-7.5	11.7	-	-11000	-	-	RNAV1
004	TF	COPSE	-	188 (180.8)	-7.5	14.3	-	-	-	-	RNAV1
005	TF	COACH	-	185 (177.8)	-7.5	9.4	-	8000	210	-	RNAV1
006	TF	TT465	-	187 (179.6)	-7.5	8.0	-	-	-	-	RNAV1
007	TF	TT466	-	136 (128.9)	-7.5	6.4	-	-	-	-	RNAV1
008	TF	TT467	-	161 (153.5)	-7.5	5.0	-	-	-	-	RNAV1
009	TF	EDDIE	-	186 (178.0)	-7.5	6.4	-	8000	210	-	RNAV1
010	TF	CREAM	-	291 (283.1)	-7.5	13.0	-	-	-	-	RNAV1

Path	Waypoint Identifier	Inbound Course °M(T)	Magnetic Variation	Outbound Time (MIN)	Outbound Distance (NM)	Turn Direction	Minimum Altitude (FT)	Maximum Altitude (FT)	Speed (KIAS)	Navigation Specification
Hold	POLIX	310 (302.3)	-7.5	1.0(-14000) 1.5(+14001)	-	L	11000	-	-230(-14000) -240(+14001)	RNAV1
Hold	COLOR	197 (189.1)	-7.5	1.0(-14000) 1.5(+14001)	-	R	8000	-	-230(-14000) -240(+14001)	RNAV1
Hold	COACH	185 (177.8)	-7.5	1.0(-14000) 1.5(+14001)	-	R	4000	-	-230(-14000) -240(+14001)	RNAV1
Hold	CREAM	291 (283.1)	-7.5	1.0(-14000) 1.5(+14001)	-	R	4000	-	-230(-14000) -240(+14001)	RNAV1

Waypoint Coordinates

Waypoint Identifier	Coordinates	Waypoint Identifier	Coordinates
ARLON	351525.3N / 1395859.8E	POLIX	361237.1N / 1402622.5E
CHIPS	361247.7N / 1401436.9E	TT465	352939.2N / 1401235.4E
COACH	353736.0N / 1401231.5E	TT466	352539.0N / 1401840.1E
COLOR	360116.3N / 1401219.8E	TT467	352110.2N / 1402124.4E
COPSE	354658.8N / 1401205.4E	TT468	351216.4N / 1401402.6E
CREAM	351743.4N / 1400612.4E	TT469	351217.9N / 1400534.7E
EDDIE	351447.4N / 1402140.9E	UMUKI	351219.1N / 1394849.2E
KAIHO	351857.8N / 1394642.4E		

CHANGE : New PROC

STANDARD ARRIVAL CHART-INSTRUMENT

RJTT / TOKYO INTL

STAR

SINGO ARRIVAL

From over STONE, via HME R036 to HME 22.2DME, via HME 22.2DME clockwise ARC to SINGO.

Cross STONE at 11000FT, cross HME R036/28.0DME at or above 8000FT.

DOYLE ARRIVAL

From over STONE, via HME R036 to HME 22.2DME, via HME 22.2DME clockwise ARC to intercept and proceed via ITL LOC course to DOYLE.

Cross STONE at 11000FT, cross HME R036/28.0DME at or above 8000FT.

ADDUM ARRIVAL

From over ADDUM, via HME R157 to HME 25.0DME, turn right, via IHA LOC course to ARLON.

Cross ADDUM at 10000FT.

BONUS ARRIVAL

From over ADDUM, via HME R157 to HME 22.2DME, via HME 22.2DME counterclockwise ARC to intercept and proceed via IKL LOC course to BONUS.

Cross ADDUM at 10000FT.

STANDARD ARRIVAL CHART-INSTRUMENT

RJTT / TOKYO INTL

STAR

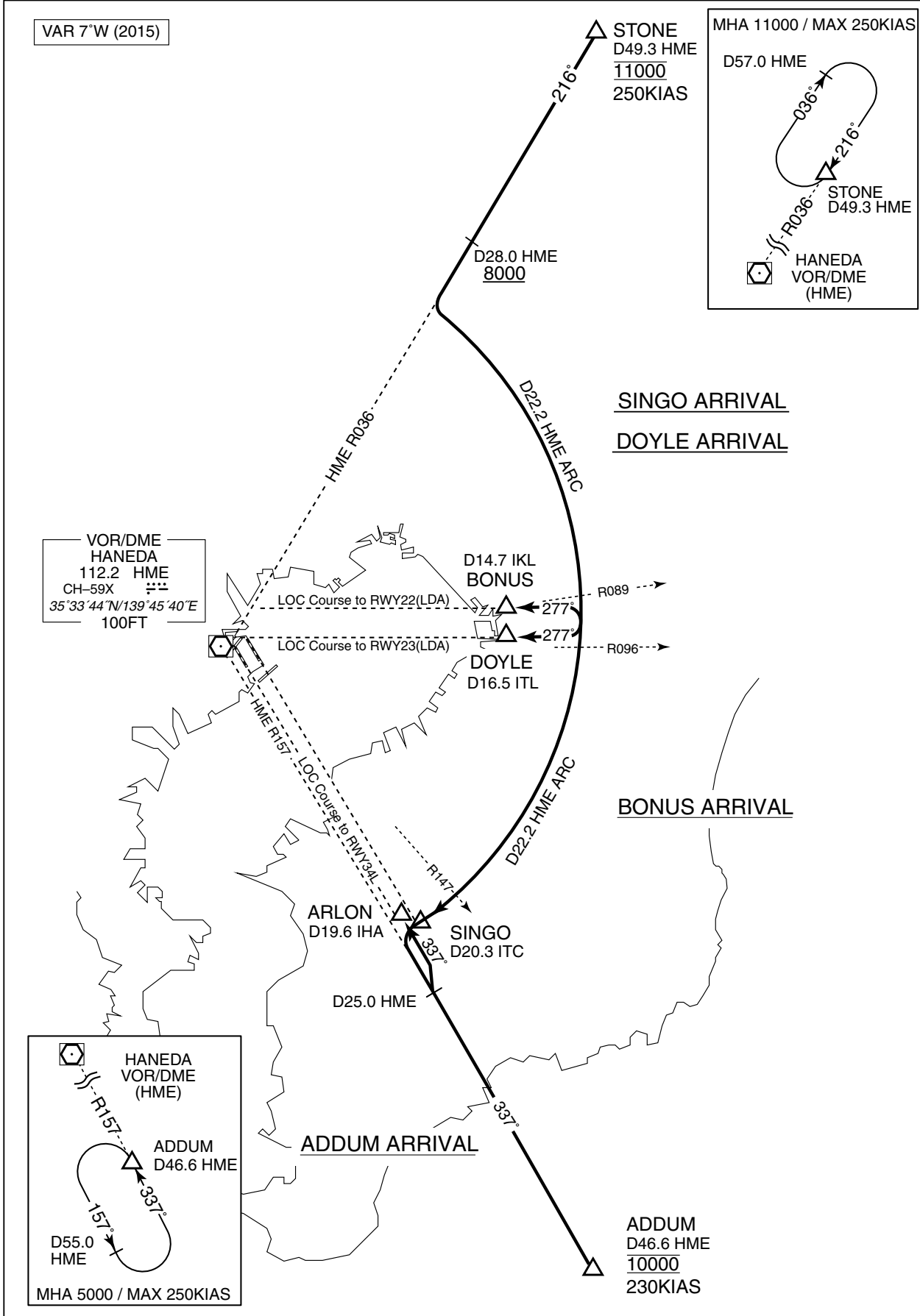

INSTRUMENT APPROACH CHART

RJTT / TOKYO INTL

ILS Z RWY34L

TOKYO APP 119.1 - 119.4 - 119.7 126.5 - 236.8 - 261.2	ILS - LOC 111.7 IHA ILS-GP 333.5 ILS-DME CH-54X	TOKYO TOWER 118.1 - 124.35 - 118.575 118.725 - 118.8	RADAR AVBL ATIS 128.8
---	--	--	--------------------------

Simultaneous approach authorized with RWY34R

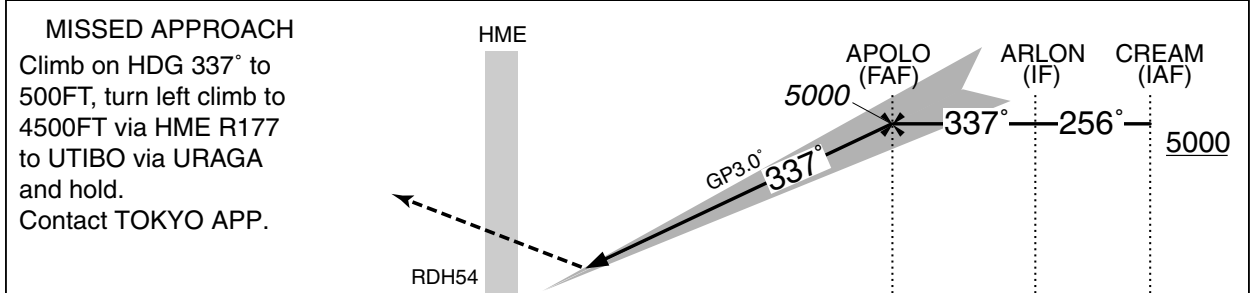
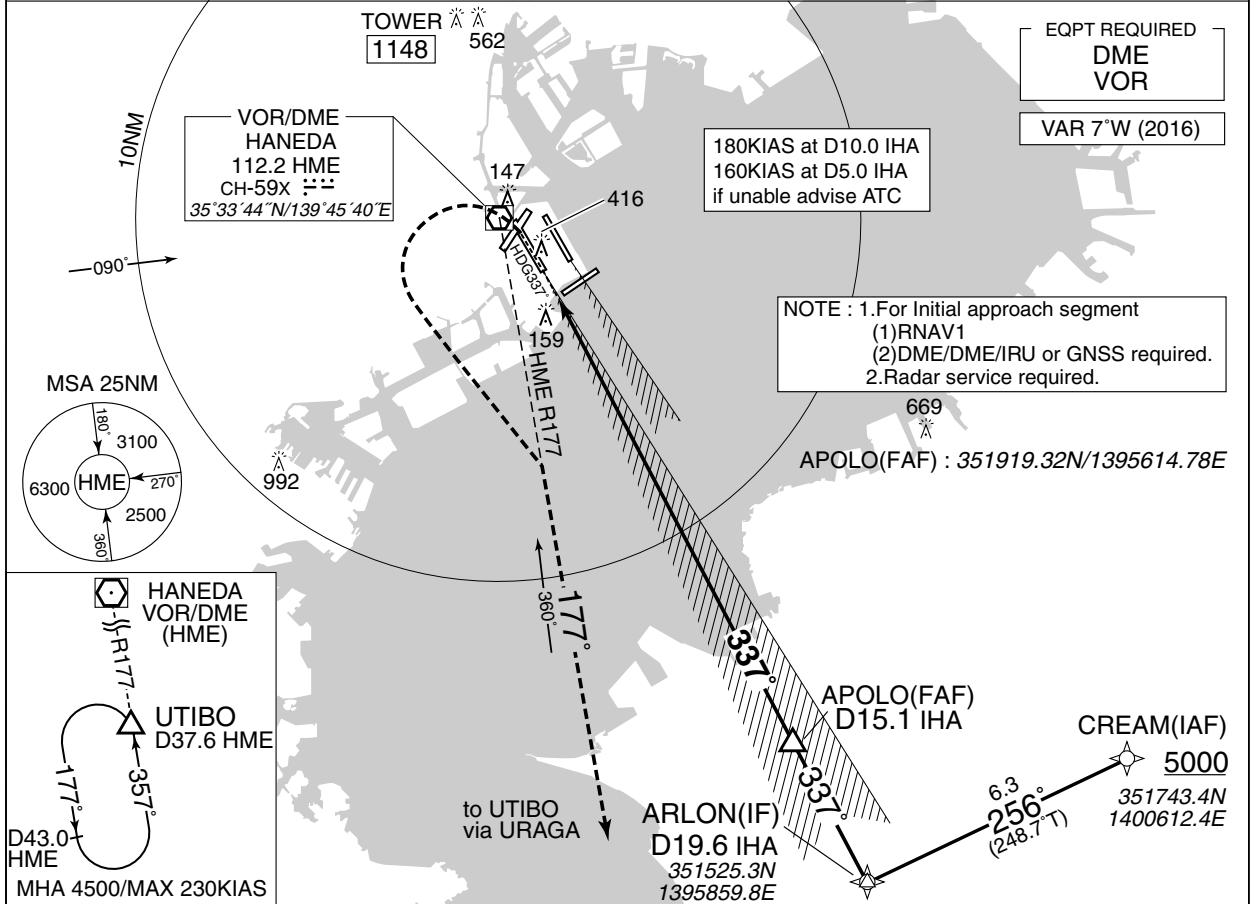

DME to IHA	0.2	15.1	19.6
NM to THR	0	14.9	19.4

Missed APCH climb gradient MNM 5.0%

MINIMA	THR elev. 18	AD elev. 21		
CAT	CAT I		CIRCLING	
	DA(H)	RVR/CMV	MDA(H)	VIS
A	218 (200)	550	730 (709)	1600
B				2400
C				2400
D				3200

MINIMA with Missed APCH climb gradient of 2.5% are not established.  
Circling is not authorized during the night time, except counterclockwise circling to RWY 16R/16L/34R.

INSTRUMENT APPROACH CHART

RJTT / TOKYO INTL

LOC Z RWY34L

TOKYO APP 119.1 - 119.4 - 119.7 126.5 - 236.8 - 261.2	ILS - LOC 111.7 IHA ILS-DME CH-54X	TOKYO TOWER 118.1 - 124.35 - 118.575 118.725 - 118.8	RADAR AVBL ATIS 128.8
---	--	--	--------------------------

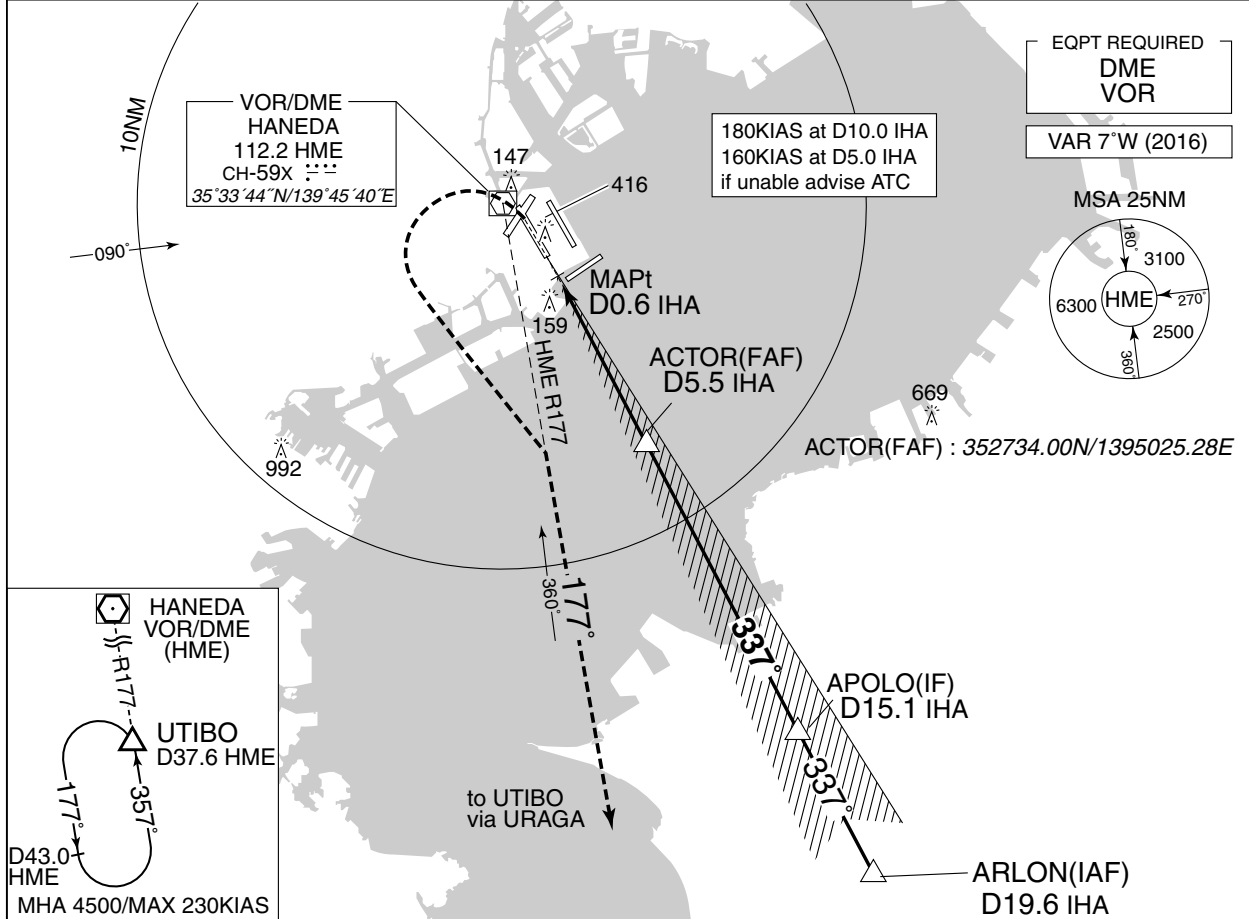

	NM to IHA	MAPt	2	3	4	5	FAF
	ALT (3.0° APCH Path)	-	646	964	1283	1601	1768

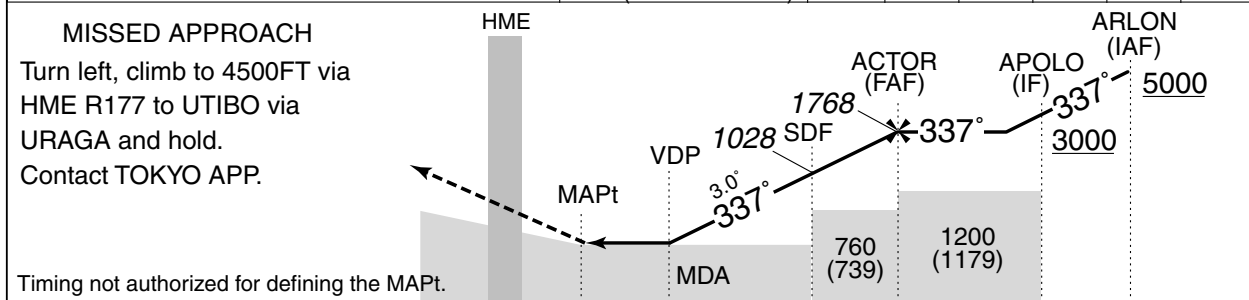

DME to IHA	0.2	0.6	1.8	3.2	5.5	15.1	19.6
NM to THR	0	0.5	1.6	3.0	5.3	14.9	19.4

MINIMA		THR elev. 18		AD elev. 21	
CAT	LOC		CIRCLING		VIS
	MDA(H)	RVR/CMV	MDA(H)		
A	560 (539)	1000	730 (709)	1600	
B		1200		2400	
C		1600		3200	
D					

Circling is not authorized during the night time, except counterclockwise circling to RWY 16R/16L/34R.

INSTRUMENT APPROACH CHART

RJTT / TOKYO INTL

ILS Y RWY34L

TOKYO APP 119.1 - 119.4 - 119.7 126.5 - 236.8 - 261.2	ILS - LOC 111.7 IHA ILS-GP 333.5 ILS-DME CH-54X	TOKYO TOWER 118.1 - 124.35 - 118.575 118.725 - 118.8	RADAR AVBL ATIS 128.8
---	--	--	--------------------------

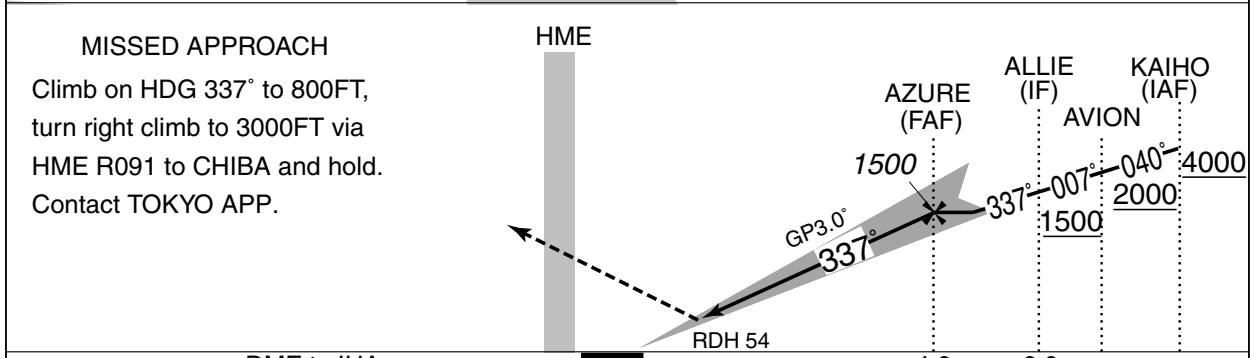
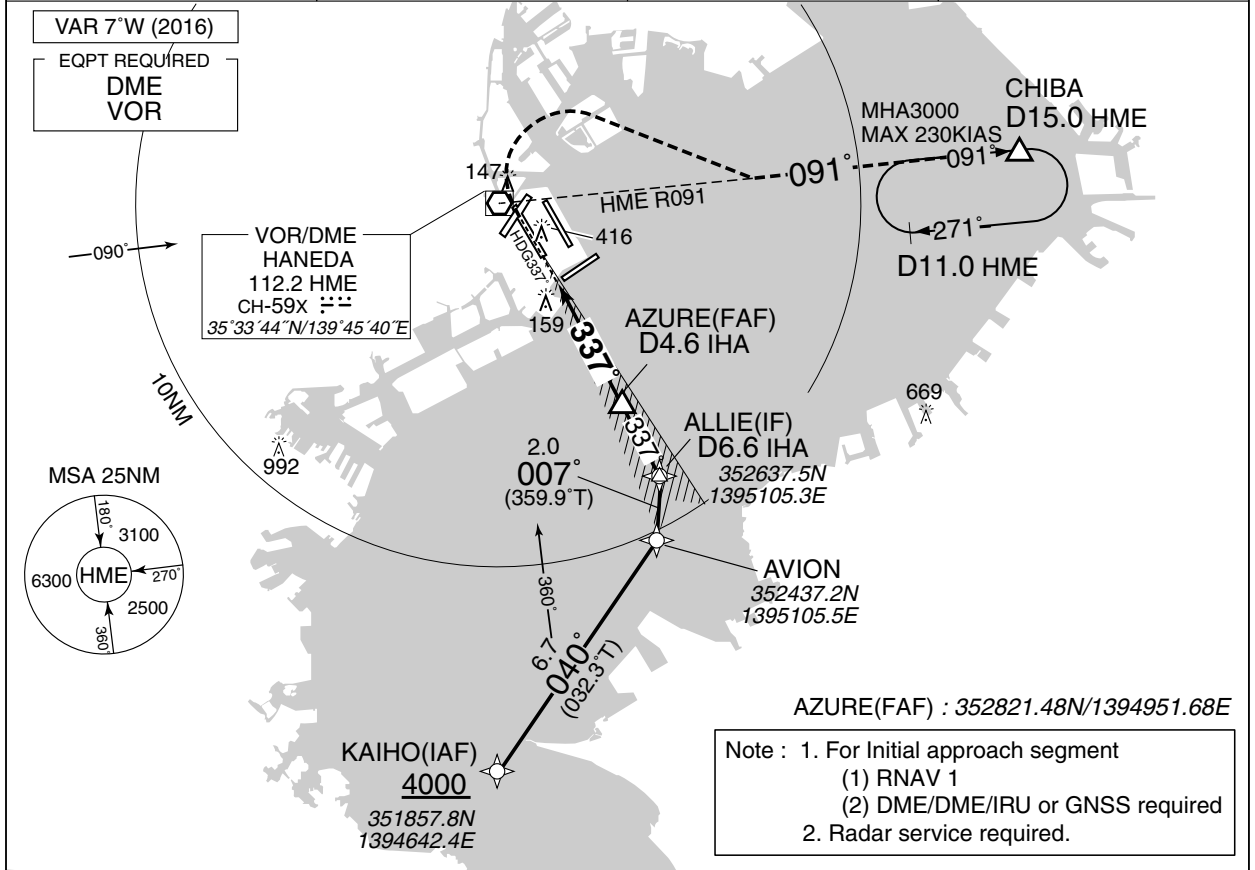

DME to IHA	0.2	4.6	6.6
NM to THR	0	4.4	6.4

Missed APCH climb gradient MNM 5.0%

MINIMA		THR elev. 18	AD elev. 21	
CAT	CAT I		CIRCLING	
	DA(H)	RVR/CMV	MDA(H)	VIS
A	218 (200)	550	730 (709)	1600
B				2400
C				2400
D				3200

MINIMA with Missed APCH climb gradient of 2.5% are not established.  
Circling is not authorized during the night time, except counterclockwise circling to RWY16R/16L/34R.

INSTRUMENT APPROACH CHART

RJTT / TOKYO INTL

LOC Y RWY34L

TOKYO APP 119.1 - 119.4 - 119.7 126.5 - 236.8 - 261.2	ILS - LOC 111.7 IHA ILS-DME CH-54X	TOKYO TOWER 118.1 - 124.35 - 118.575 118.725 - 118.8	RADAR AVBL ATIS 128.8
---	--	--	--------------------------

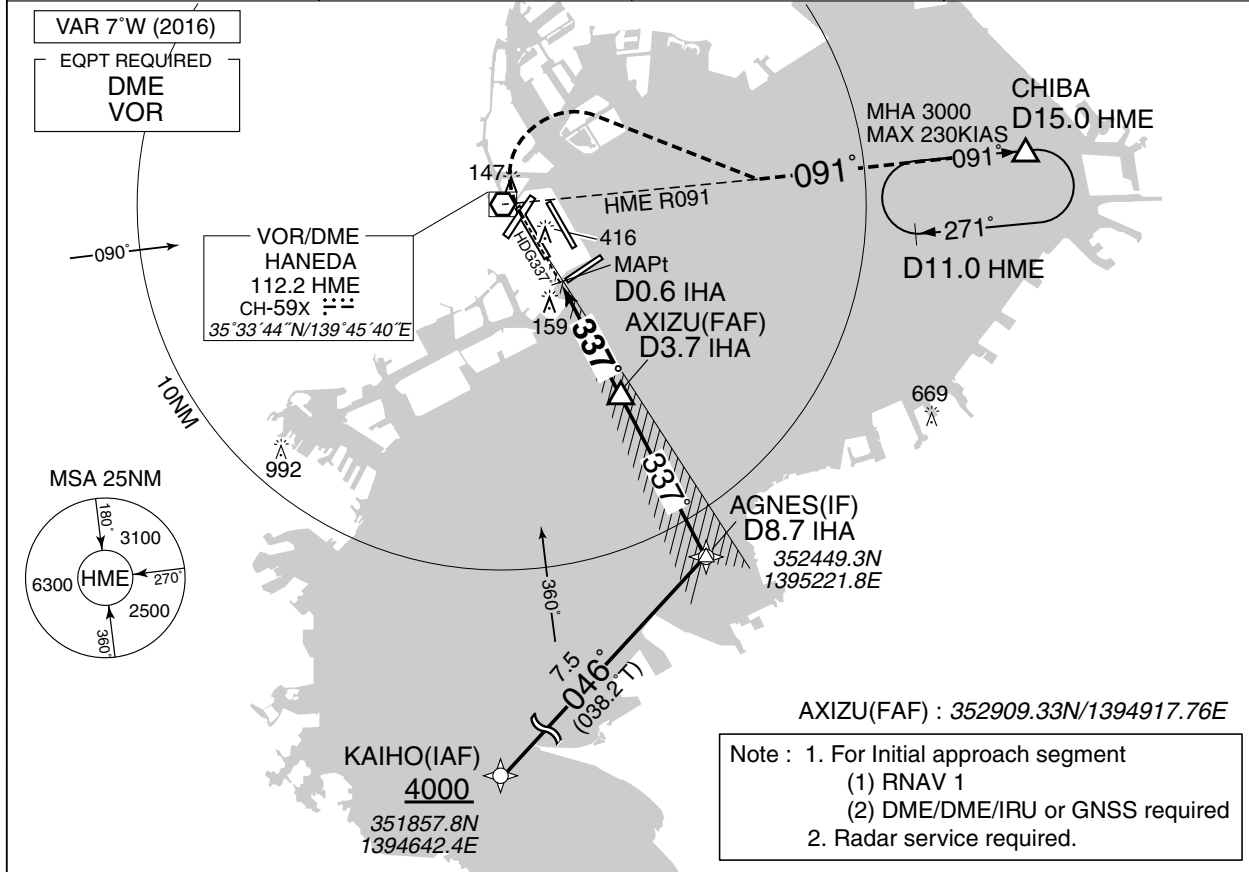

NM to IHA	MAPt	2	3	FAF
ALT (3.0° APCH Path)	-	646	964	1184

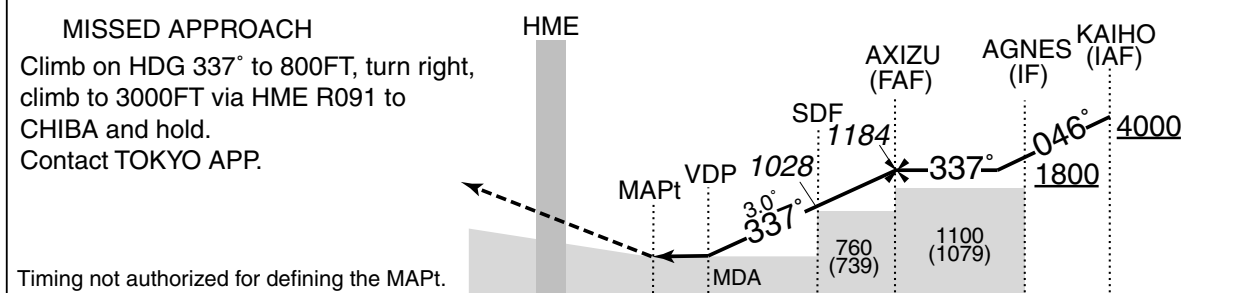

DME to IHA	0.2	0.6	1.8	3.2	3.7	8.7
NM to THR	0.5	1.6	3.0	3.5	8.5	

MINIMA		THR elev. 18	AD elev. 21	
CAT	LOC		CIRCLING	
	MDA(H)	RVR/CMV	MDA(H)	VIS
A	560 (539)	1000	730 (709)	1600
B		1200		2400
C				1600
D				

Circling is not authorized during the night time, except counterclockwise circling to RWY 16R/16L/34R.



INSTRUMENT APPROACH CHART

RJTT / TOKYO INTL

ILS Z RWY34R (CAT II & III)

TOKYO APP 119.1 - 119.4 - 119.7 126.5 - 236.8 - 261.2	ILS - LOC 108.9 ITC ILS - GP 329.3 ILS - DME CH - 26X	TOKYO TOWER 124.35 - 118.1 - 118.575 118.725 - 118.8	RADAR AVBL ATIS 128.8
---	--	--	--------------------------

Simultaneous approach authorized with RWY34L

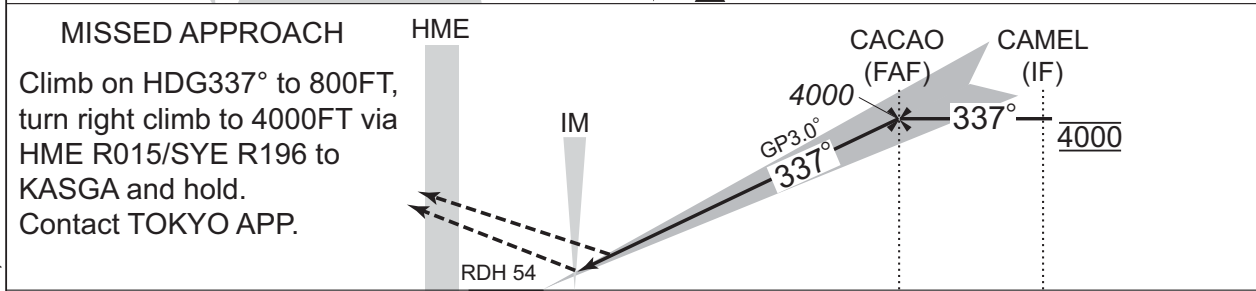
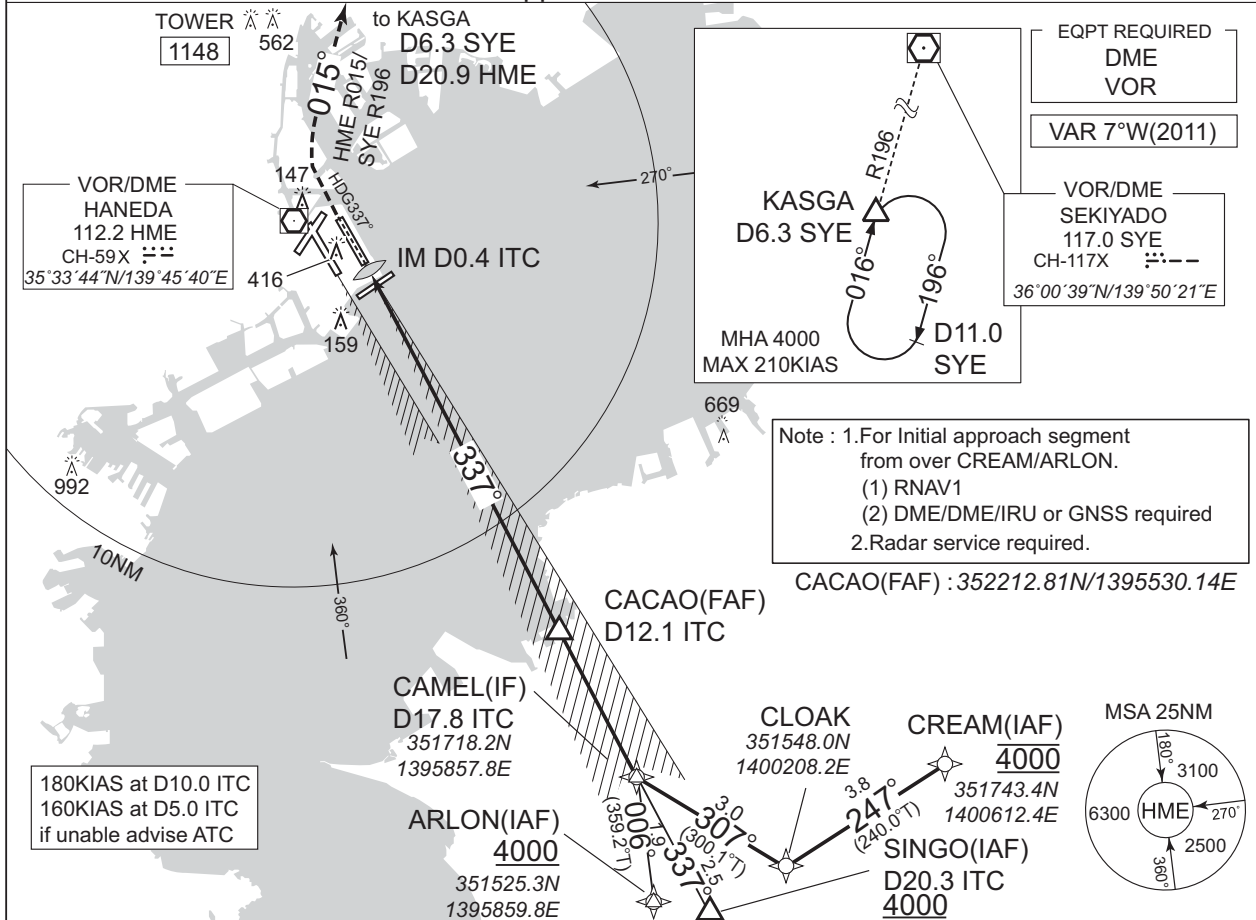

DME to ITC	0.2 0.4	12.1	17.8
NM to THR	0 0.2	11.9	17.6

Missed APCH climb gradient MNM 5.0%

MINIMA		THR elev. 20		AD elev. 21				
CAT	CAT III		CAT II		CAT I		CIRCLING	
	RVR	DA(H)	RA	RVR	DA(H)	RVR/CMV	MDA(H)	VIS
A								1600
B	100	120(100)	100	300	220(200)	550	730(709)	2400
C								3200
D								

MINIMA with Missed APCH climb gradient of 2.5% are not established.  
Circling is not authorized during the night time, except counterclockwise circling to RWY 16R/16L and clockwise circling to RWY34L.

CHANGE: MINIMA(CAT III, II B → CAT III)

INSTRUMENT APPROACH CHART

RJTT / TOKYO INTL

LOC Z RWY34R

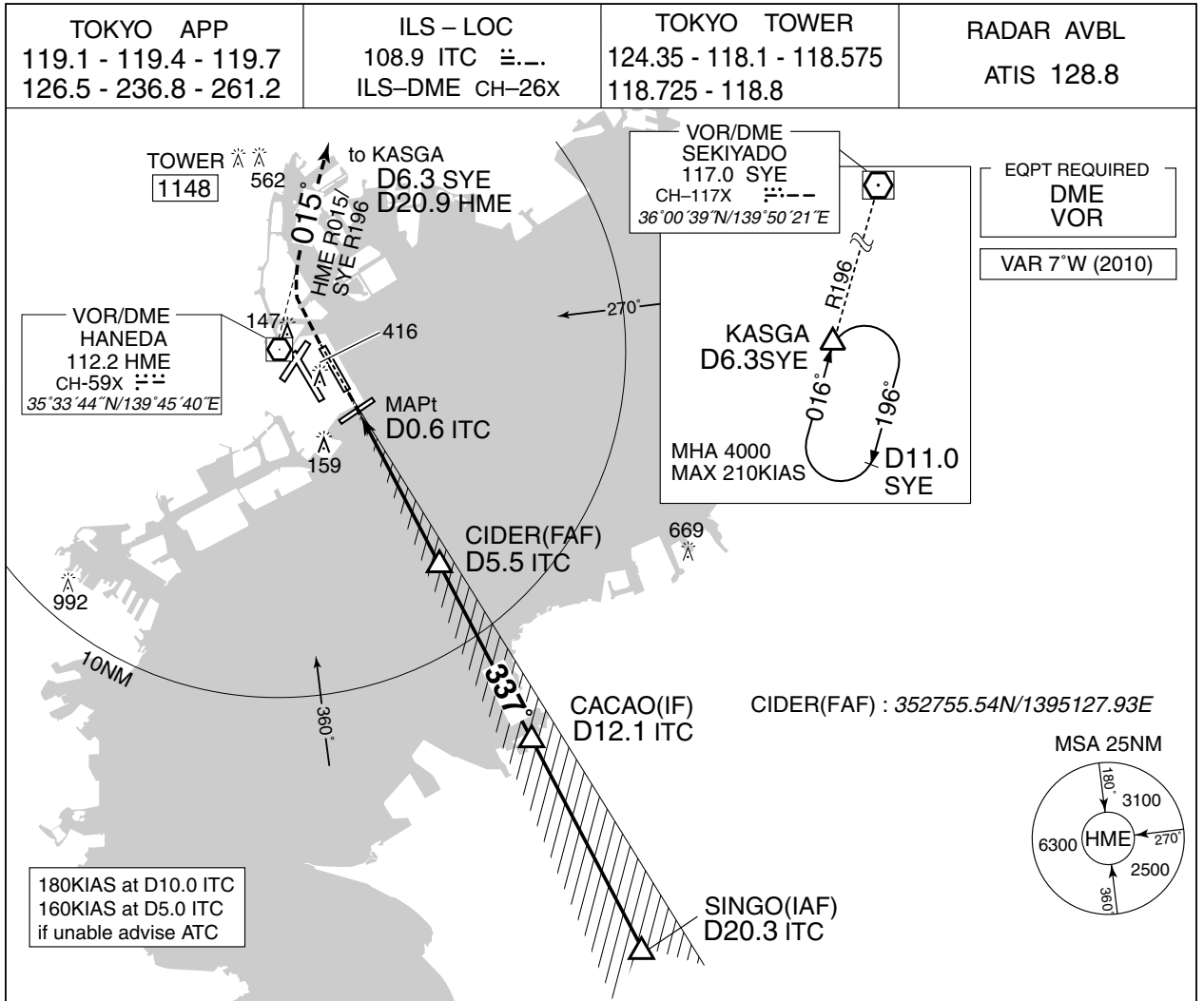

	NM to ITC	MAPt	3	4	5	FAF
	ALT (3.0° APCH Path)	-	970	1289	1607	1768

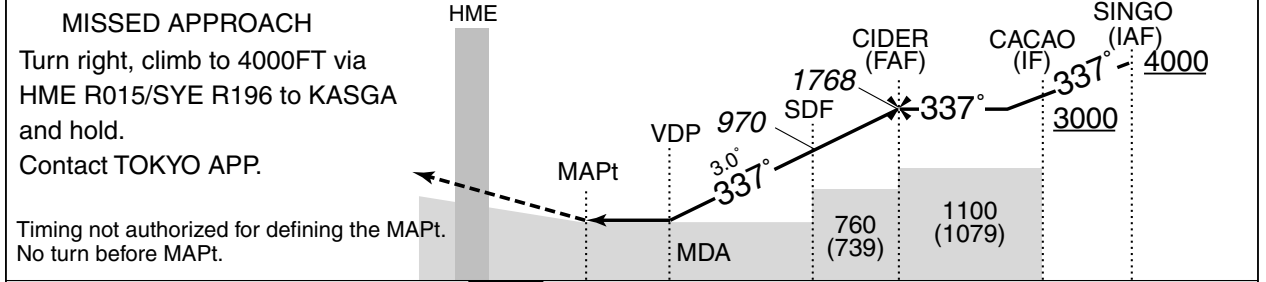

DME to ITC	0.2	0.6	2.1	3.0	5.5	12.1	20.3
NM to THR	0	0.5	1.9	2.8	5.3	11.9	20.1

Missed APCH climb gradient MNM 3.0%

MINIMA		THR elev. 20		AD elev. 21	
CAT	LOC		CIRCLING		VIS
	MDA(H)	RVR/CMV	MDA(H)		
A	700 (679)	1200	730 (709)	1600	
B		1400		2400	
C				1800	3200
D					

MINIMA with Missed APCH climb gradient of 2.5% are not established.  
Circling is not authorized during the night time, except counterclockwise circling to RWY 16R/16L and clockwise circling to RWY 34L.

AERODROME OBSTACLE CHART-ICAO  
TYPE A(OPERATING LIMITATIONS)

DIMENSIONS AND ELEVATIONS IN FEET BEARINGS ARE MAGNETIC

MAGNETIC VARIATION 7°W-APR 2015

TOKYO INTERNATIONAL AIRPORT  
RWY:16R/34L

DECLARED DISTANCES		
RWY 16R		RWY 34L
9840	TAKE OFF RUN AVAILABLE	9840
9840	TAKE OFF DISTANCE AVAILABLE	9840
9840	ACCELERATE STOP DISTANCE AVAILABLE	9840
8260	LANDING DISTANCE AVAILABLE	9840

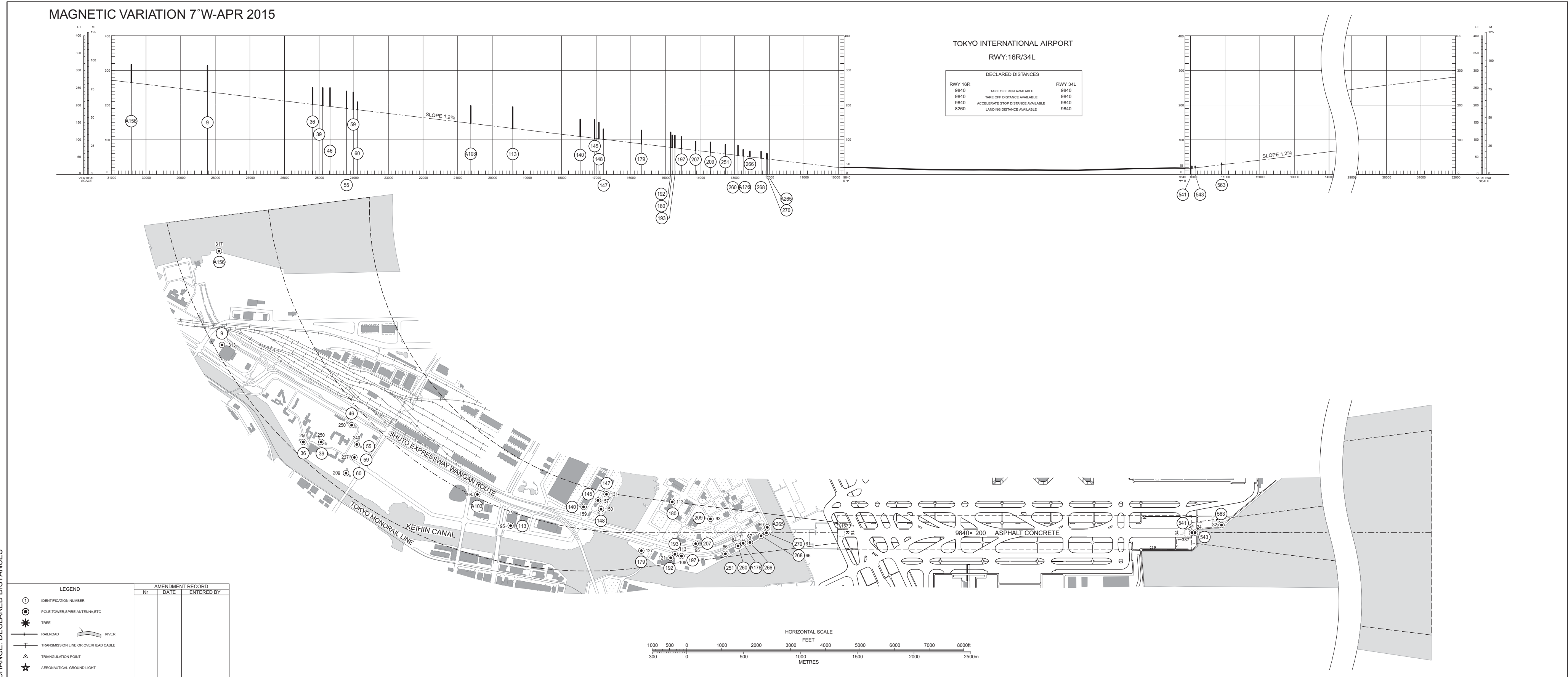

CHANGE: DECLARED DISTANCES

INSTRUMENT APPROACH CHART

RJTT / TOKYO INTL ILS Y RWY34R (CAT II & III)

TOKYO APP 119.1 - 119.4 - 119.7 126.5 - 236.8 - 261.2	ILS - LOC 108.9 ITC 3... ILS - GP 329.3 ILS - DME CH - 26X	TOKYO TOWER 124.35 - 118.1 - 118.575 118.725 - 118.8	RADAR AVBL ATIS 128.8
---	---	--	--------------------------

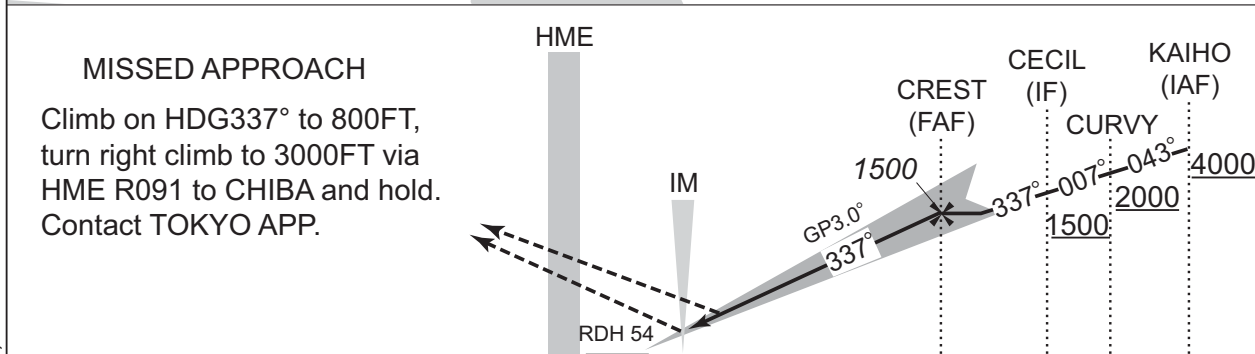
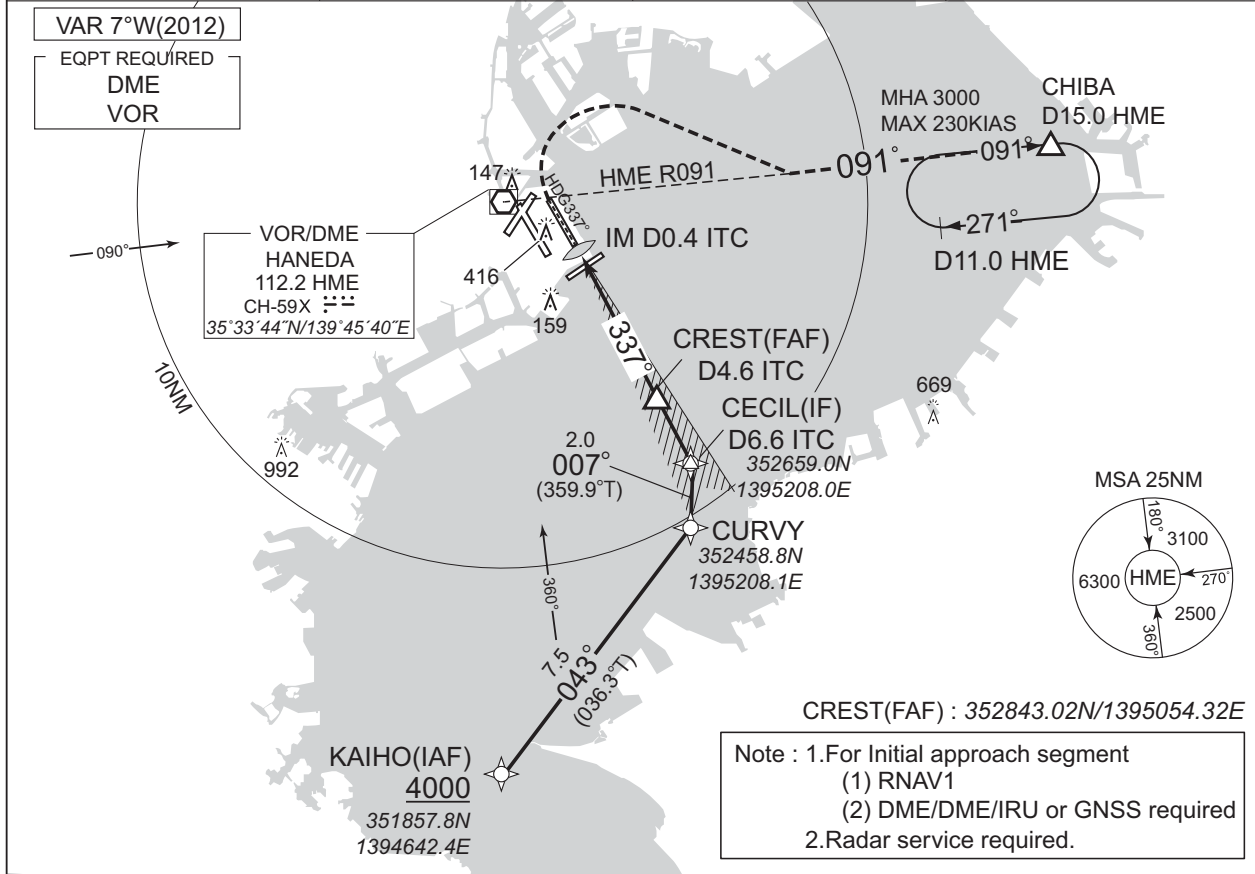

DME to ITC	0.2	0.4	4.6	6.6
NM to THR	0	0.2	4.4	6.4

MISSED APCH climb gradient MNM 5.0%

CAT	THR elev. 20				AD elev. 21		CIRCLING	
	CAT III	CAT II		CAT I		MDA(H)	VIS	
	RVR	DA(H)	RA	RVR	DA(H)			
A	100	120(100)	100	300	220(200)	550	730(709)	1600
B								2400
C								2400
D								3200

MINIMA with Missed APCH climb gradient of 2.5% are not established.  
Circling is not authorized during the night time, except counterclockwise circling to RWY 16R/16L and clockwise circling to RWY34L.

CHANGE: MINIMA(CAT IIIA, IIIB → CAT III).

INSTRUMENT APPROACH CHART

RJTT / TOKYO INTL

LOC Y RWY34R

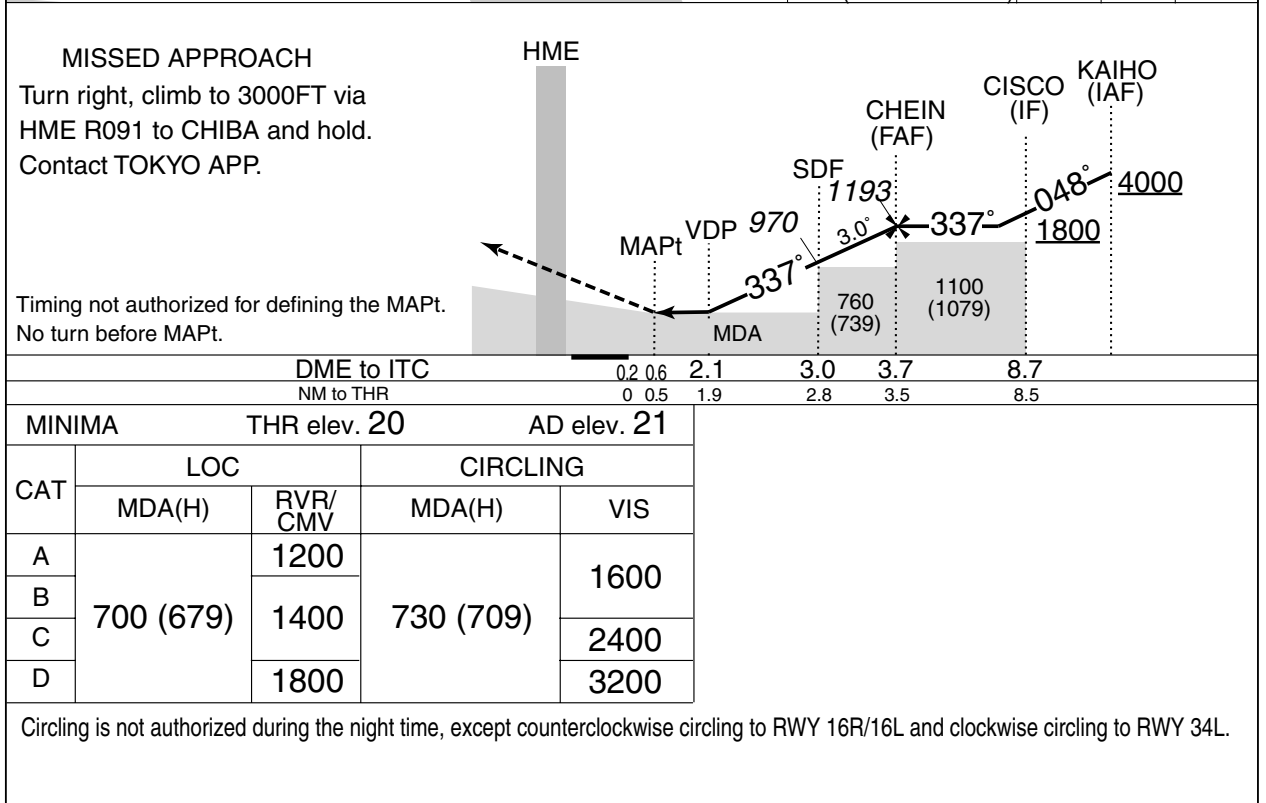
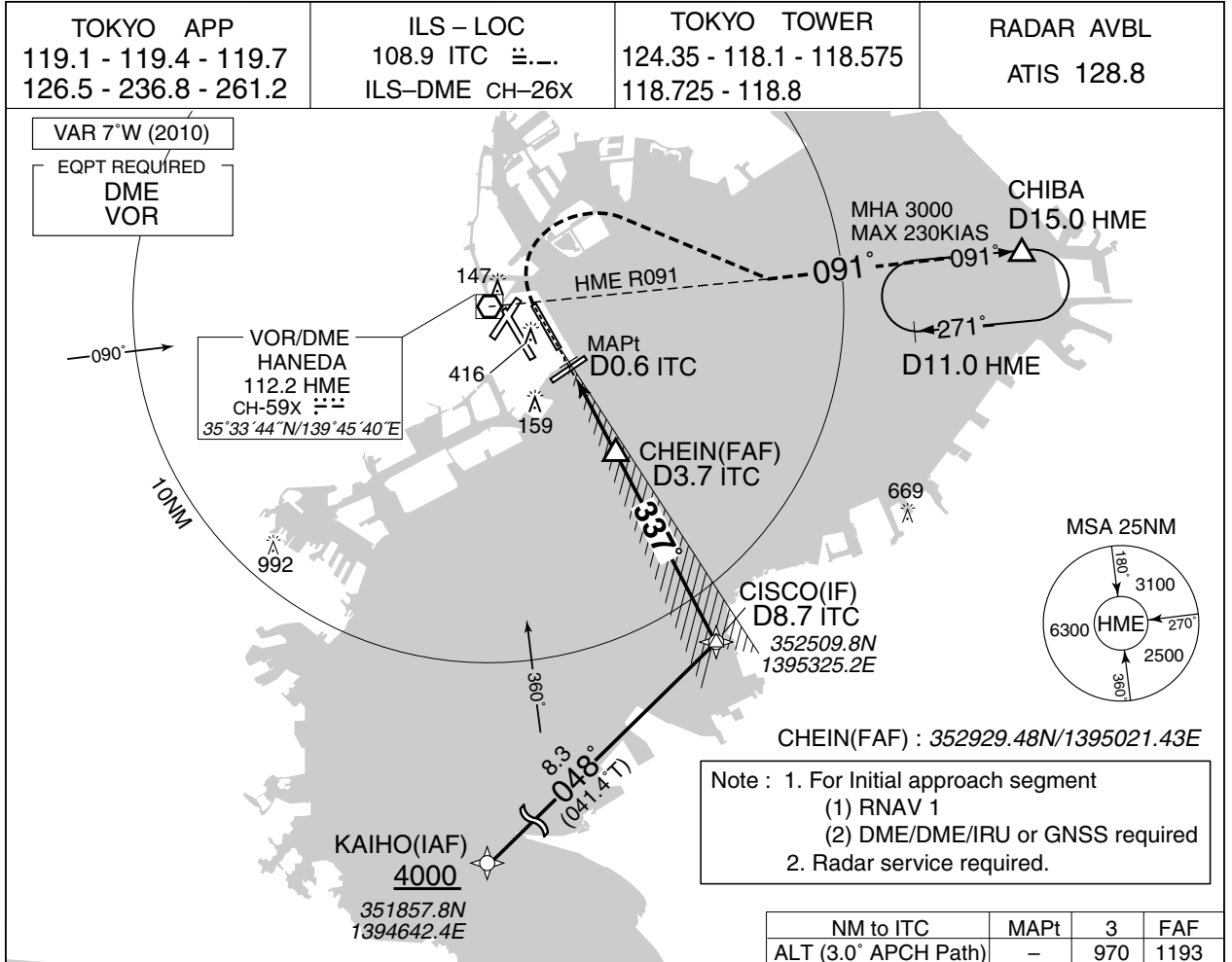

INSTRUMENT APPROACH CHART

RJTT / TOKYO INTL

ILS RWY22

TOKYO APP 119.1 - 119.4 - 119.7 126.5 - 236.8 - 261.2	ILS - LOC 108.1 IAD ILS-GP 334.7 ILS-DME CH-18X	TOKYO TOWER 118.575 - 118.1 - 124.35 118.725 - 118.8	RADAR AVBL ATIS 128.8
---	--	--	--------------------------

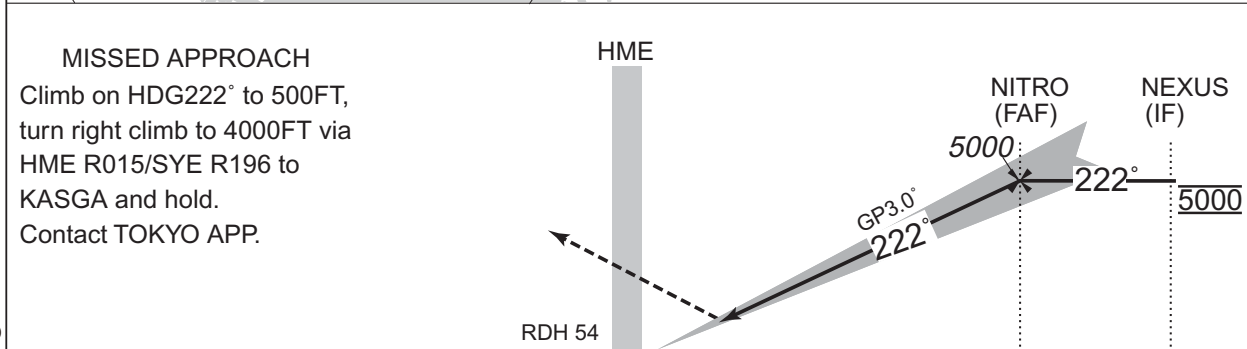
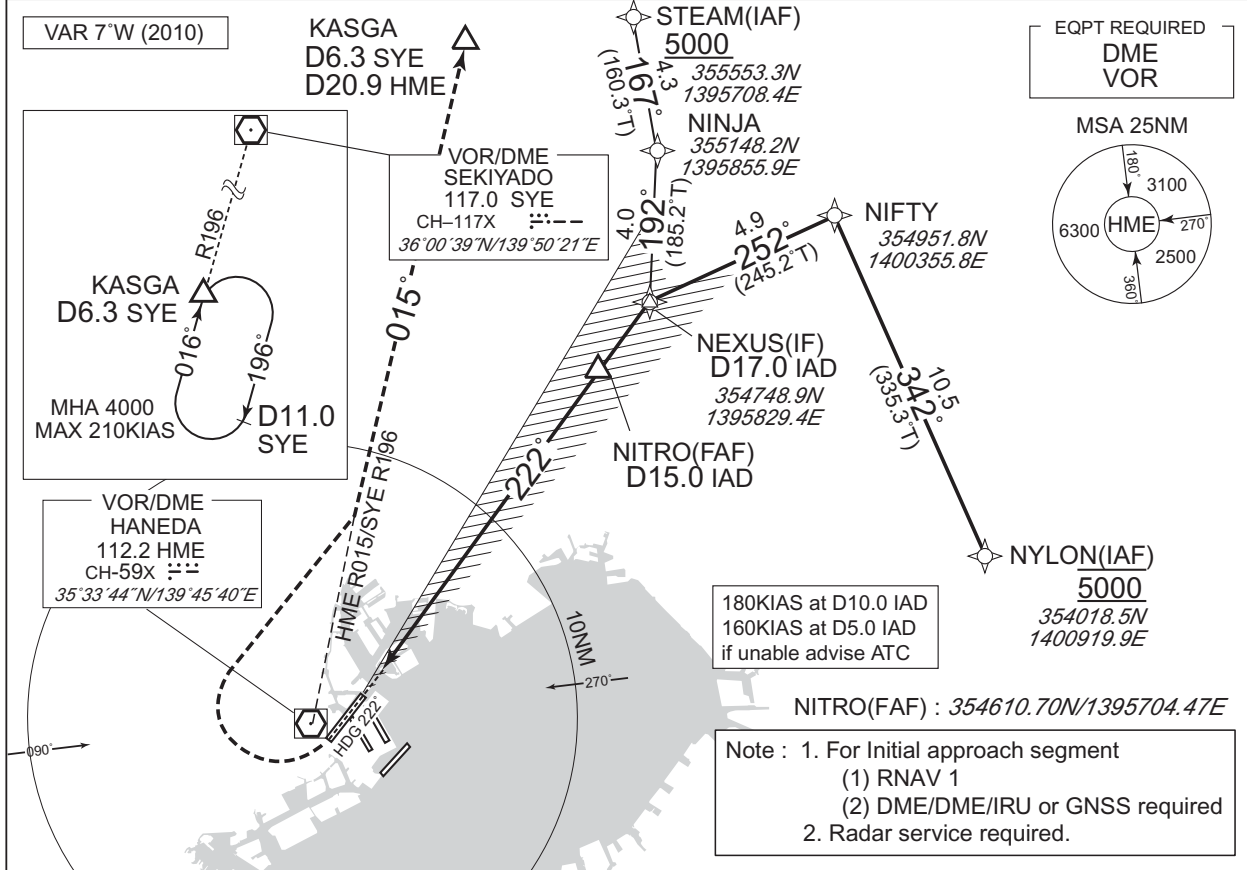

Missed APCH climb gradient MNM 6.0% due to airspace restrictions.

MINIMA		THR elev. 35	AD elev. 21	
CAT	CAT I		CIRCLING	
	DA(H)	RVR/CMV	MDA(H)	VIS
A	235 (200)	550	730 (709)	1600
B				2400
C				3200
D				

MINIMA with Missed APCH climb gradient below 6.0% are not established. Circling is not authorized during the night time, except counterclockwise circling to RWY16R/16L and clockwise circling to RWY23, RWY34R/34L.

CHANGE: Description of GP angle.

INSTRUMENT APPROACH CHART

RJTT / TOKYO INTL

LOC RWY22

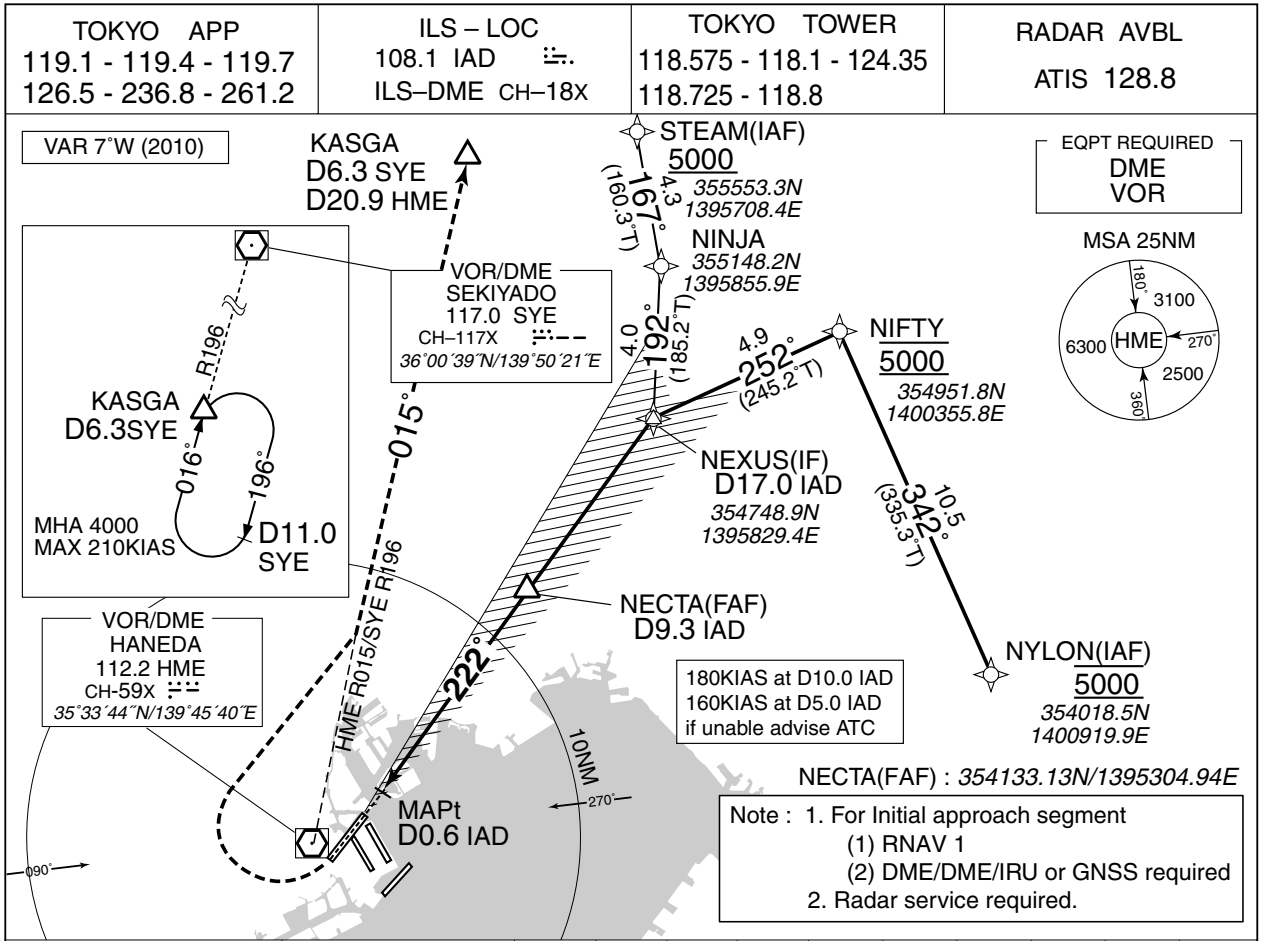

	NM to IAD	MAPt	2	3	4	5	6	7	8	9	FAF
	ALT (3.0° APCH Path)	-	662	986	1299	1618	1936	2255	2573	2891	3000

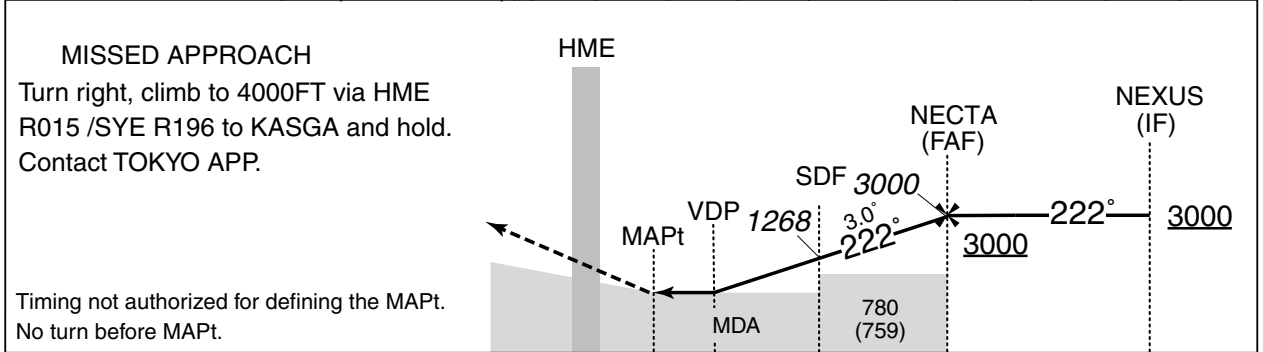

	DME to IAD	0.2	0.6	1.9	3.9	9.3	17.0
	NM to THR	0	0.5	1.7	3.7	9.1	16.8

Missed APCH climb gradient MNM 4.0%

MINIMA		THR elev. 35	AD elev. 21		
CAT	LOC		CIRCLING		
	MDA(H)	RVR/CMV	MDA(H)	VIS	
A	600 (579)	1000	730 (709)	1600	
B		1200		2400	
C				1600	3200
D					

MINIMA with Missed APCH climb gradient of 2.5% are not established.  
Circling is not authorized during the night time, except counterclockwise circling to RWY16R/16L and clockwise circling to RWY23, RWY34R/34L.



INSTRUMENT APPROACH CHART

RJTT / TOKYO INTL

LDA Z RWY22

TOKYO APP 119.1 - 119.4 - 119.7 126.5 - 236.8 - 261.2	LDA - LOC 110.1 IKL LDA-DME CH-38X	TOKYO TOWER 118.575 - 118.1 - 124.35 118.725 - 118.8	RADAR AVBL ATIS 128.8
---	--	--	--------------------------

Simultaneous approach authorized with RWY23(LDA)

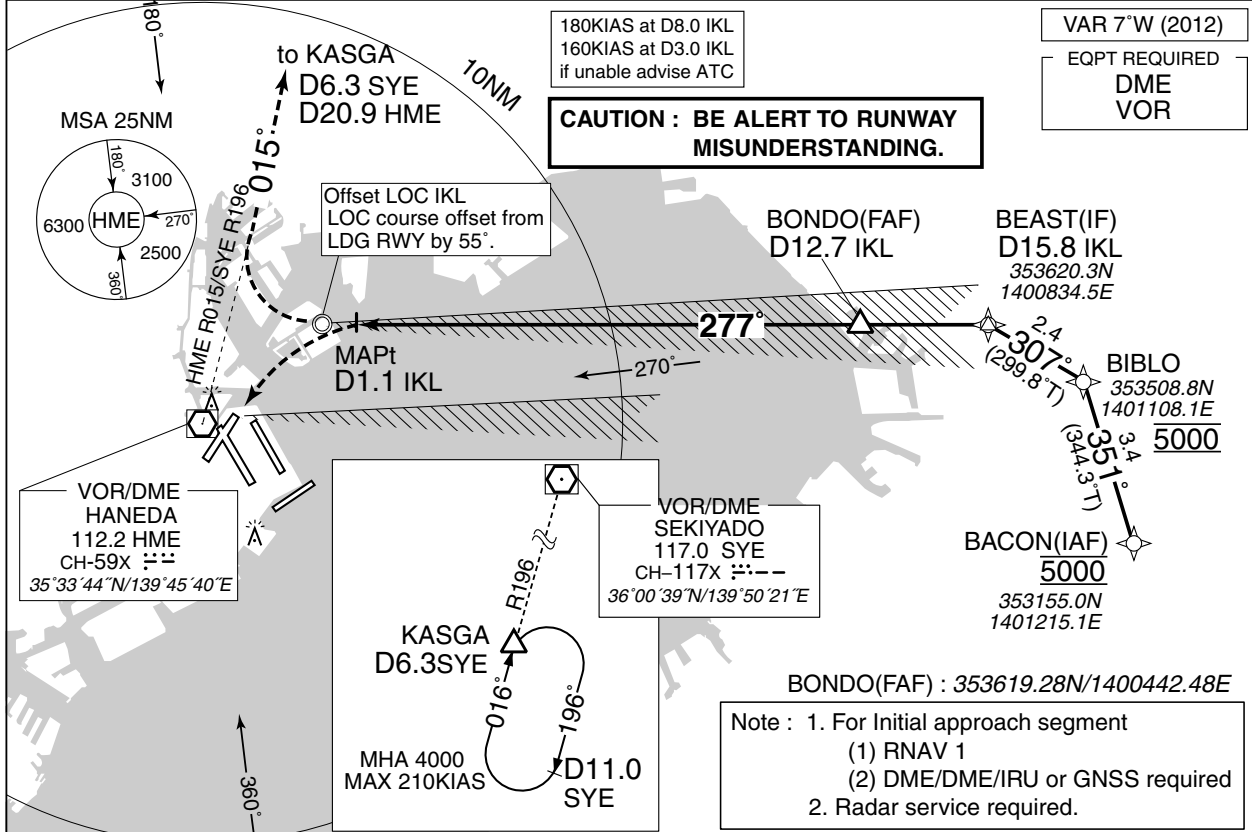

MISSED APPROACH

At MAPt, turn right climb to 4000FT via HME R015 /SYE R196 to KASGA and hold.  
Contact TOKYO APP.

Timing not authorized for defining the MAPt.

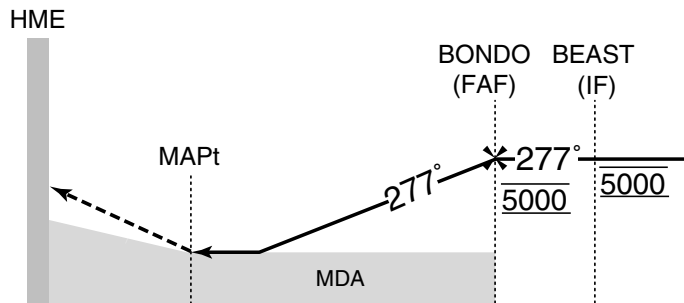

DME to IKL	1.1	12.7	15.8
NM to THR	3.8	15.4	18.5

Missed APCH climb gradient MNM 4.0%

MINIMA	THR elev. 35	AD elev. 21
CAT	MDA(H)	VIS
A	1000 (979)	6000
B		
C		
D		

**Do Not turn left  
until D1.1 IKL**

**SO AS NOT TO MISUNDERSTAND  
THE RUNWAY**

MINIMA with Missed APCH climb gradient of 2.5% are not established.  
MINIMA APPLICATION CRITERIA in AD1.6.10.1.4 are not applicable.



INSTRUMENT APPROACH CHART

RJTT / TOKYO INTL

LDA Z RWY22

Visual Prescribed Track for LDA Z RWY22

Visual manoeuvre with Prescribed Track (VPT) : VPT stands for visual maneuvering after the MAPt using prescribed track.  
 Note : Remain on the LDA until passing MAPt so as not to penetrate the NTZ, and to avoid the RWY23 traffic.

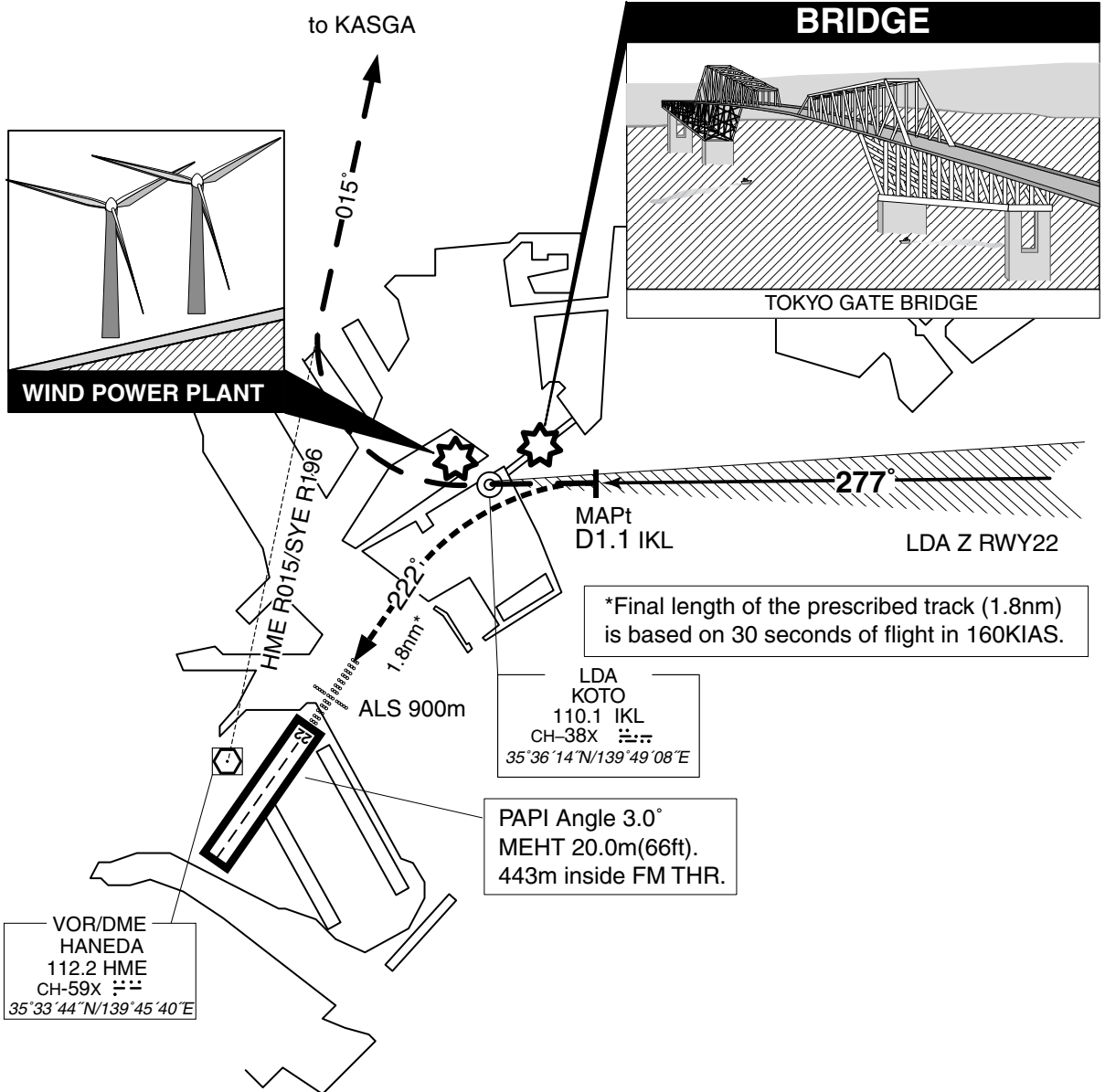

In case of GO AROUND, pilot should report ATC as soon as practicable.  
 Until receiving ATC instructions, aircraft turn right for joining HME R015/SYE R196 and missed approach procedure.

INSTRUMENT APPROACH CHART

RJTT / TOKYO INTL

LDA Y RWY22

TOKYO APP 119.1 - 119.4 - 119.7 126.5 - 236.8 - 261.2	LDA - LOC 110.1 IKL LDA-DME CH-38X	TOKYO TOWER 118.575 - 118.1 - 124.35 118.725 - 118.8	RADAR AVBL ATIS 128.8
---	--	--	--------------------------

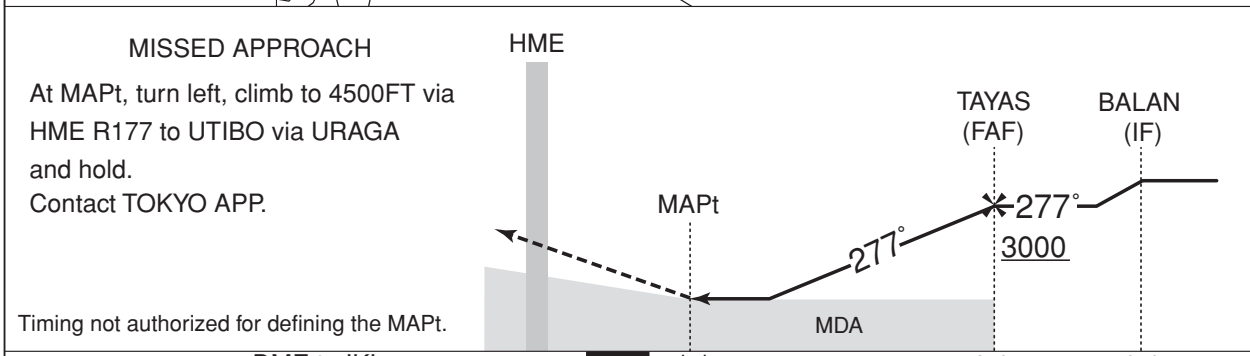
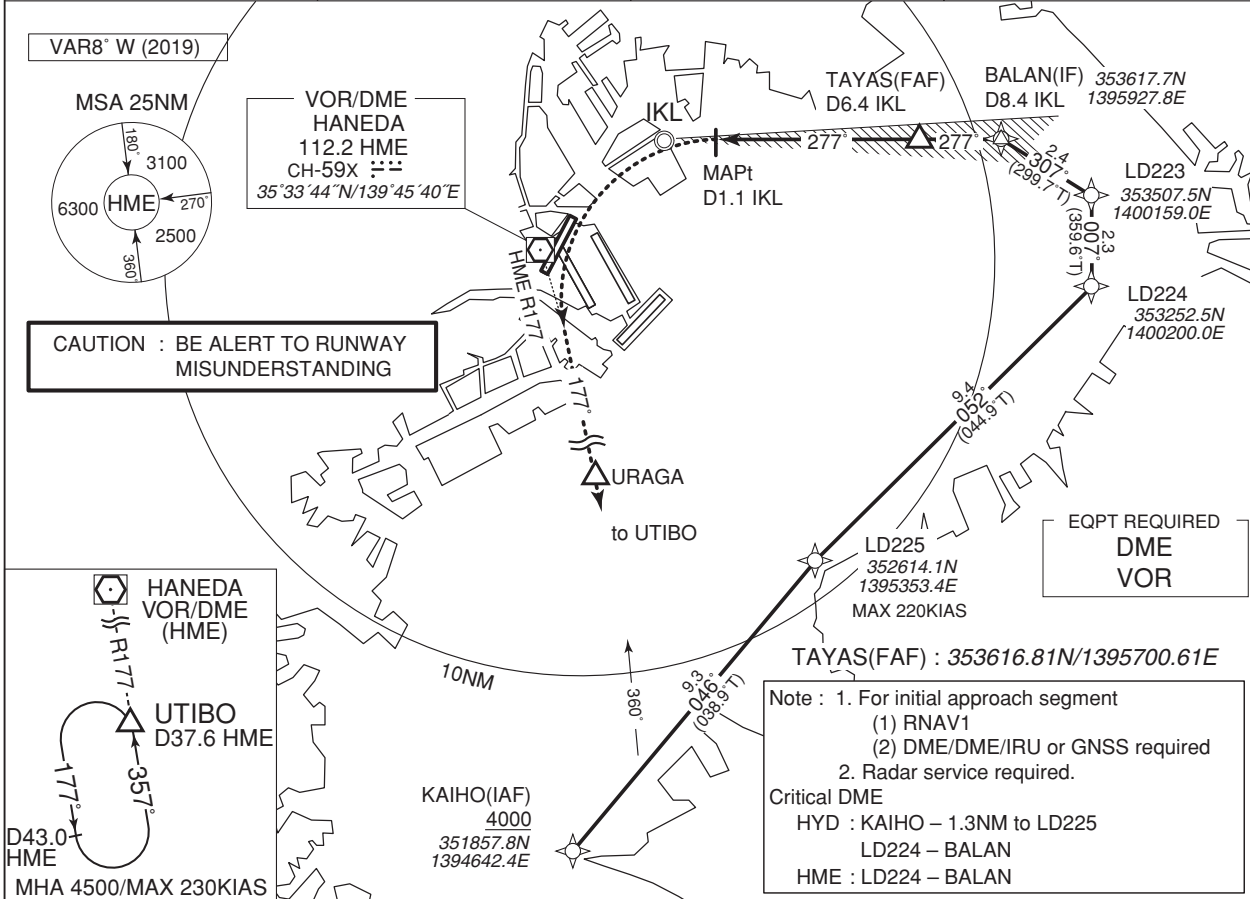

DME to IKL	1.1	6.4	8.4
NM to THR	3.8	9.1	11.1

MINIMA	THR elev. 35	AD elev. 21
CAT	MDA(H)	VIS
A		
B	1000 (979)	6000
C		
D		

**Do Not turn left until D1.1 IKL**  
**SO AS NOT TO MISUNDERSTAND THE RUNWAY**

MINIMA APPLICATION CRITERIA in AD1.1.6.10.1.4 are not applicable.

CHANGE : Update

INSTRUMENT APPROACH CHART

RJTT / TOKYO INTL

LDA Y RWY22

Visual Prescribed Track for LDA Y RWY22

Visual manoeuvre with Prescribed Track (VPT) : VPT stands for visual maneuvering after the MAPt using prescribed track.  
 Note : Remain on the LDA until passing MAPt so as not to penetrate the NTZ, and to avoid the RWY23 traffic.

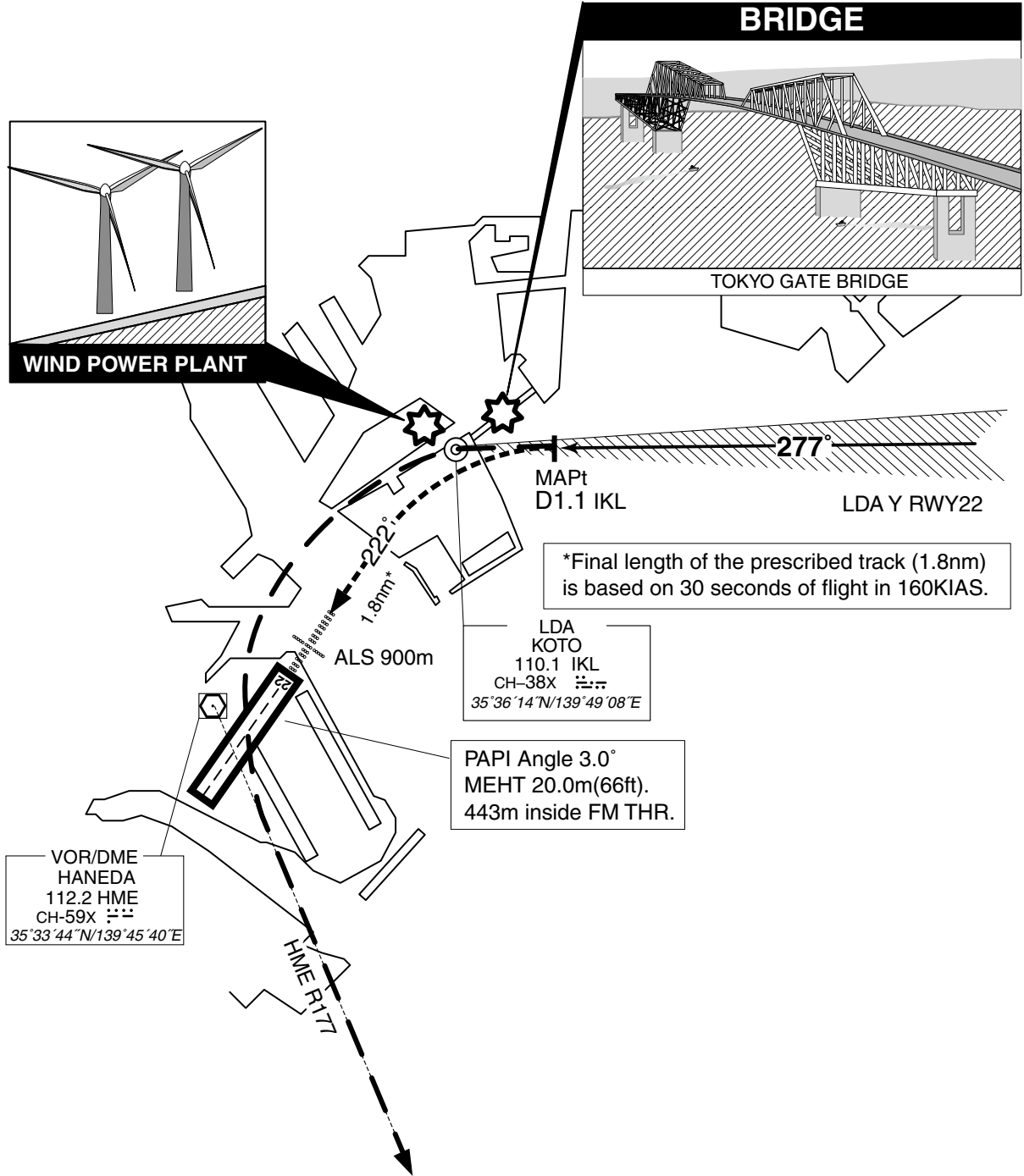

In case of GO AROUND, pilot should report ATC as soon as practicable.  
 Until receiving ATC instructions, aircraft turn left for joining HME R177 and missed approach procedure.

INSTRUMENT APPROACH CHART

RJTT / TOKYO INTL

ILS Z RWY23

TOKYO APP 119.1 - 119.4 - 119.7 126.5 - 236.8 - 261.2	ILS - LOC 110.5 ITD ILS-GP 329.6 ILS-DME CH-42X	TOKYO TOWER 124.35 - 118.1 - 118.575 118.725 - 118.8	RADAR AVBL ATIS 128.8
---	--	--	--------------------------

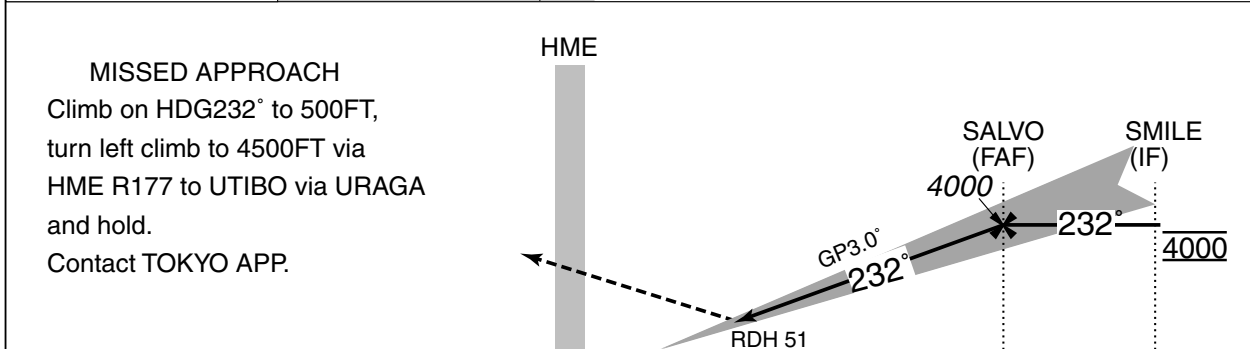
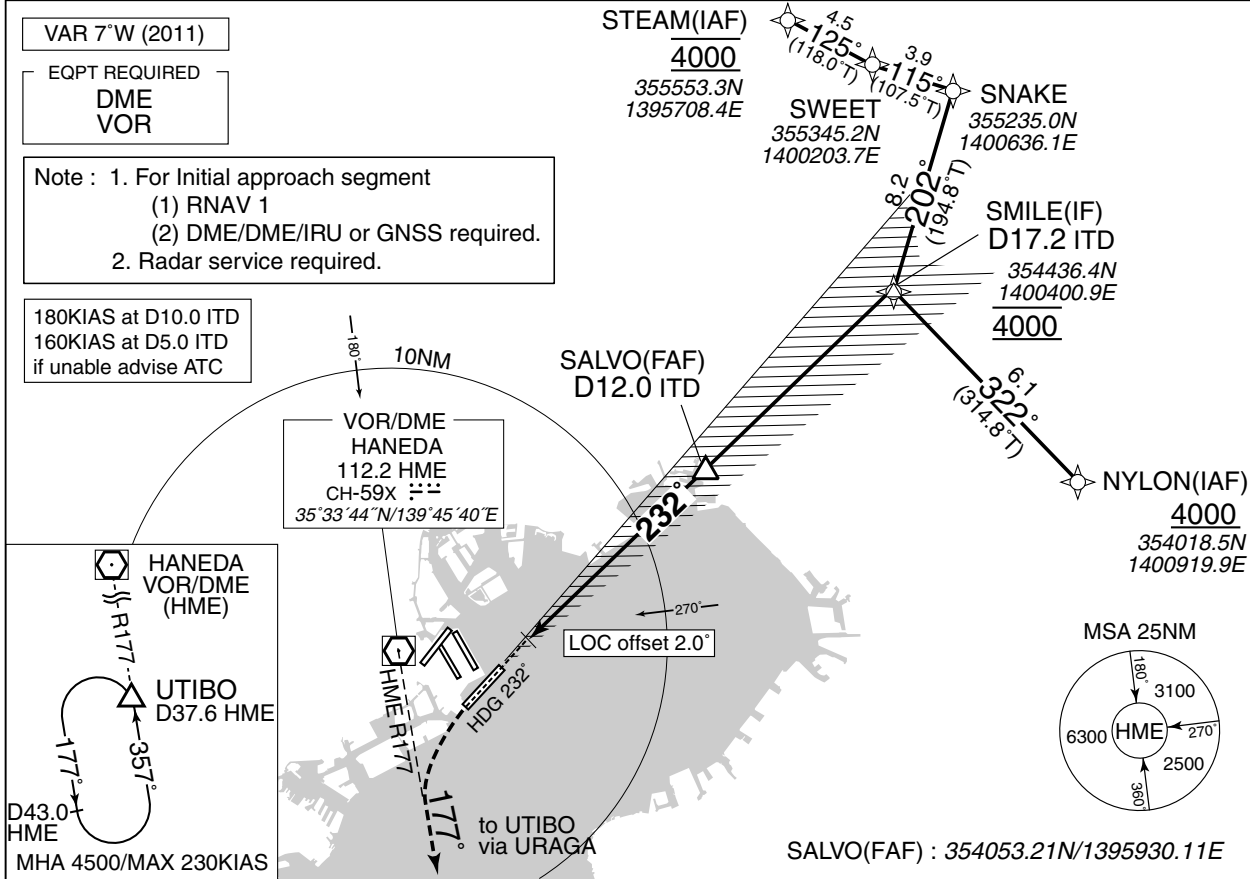

DME to ITD	0.2	12.0	17.2
NM to THR	0	11.8	17.1

MINIMA		THR elev. 55		AD elev. 21	
CAT	CAT I		CIRCLING		VIS
	DA(H)	RVR/CMV	MDA(H)		
A	383 (328)	800	730 (709)		1600
B					2400
C					3200
D					

Circling is not authorized during the night time, except counterclockwise circling to RWY22, RWY16R/16L and clockwise circling to RWY34R/34L.

**INSTRUMENT APPROACH CHART**

RJTT / TOKYO INTL

LOC Z RWY23

TOKYO APP 119.1 - 119.4 - 119.7 126.5 - 236.8 - 261.2	ILS - LOC 110.5 ITD ±.. ILS-DME CH-42X	TOKYO TOWER 124.35 - 118.1 - 118.575 118.725 - 118.8	RADAR AVBL ATIS 128.8
---	--	--	--------------------------

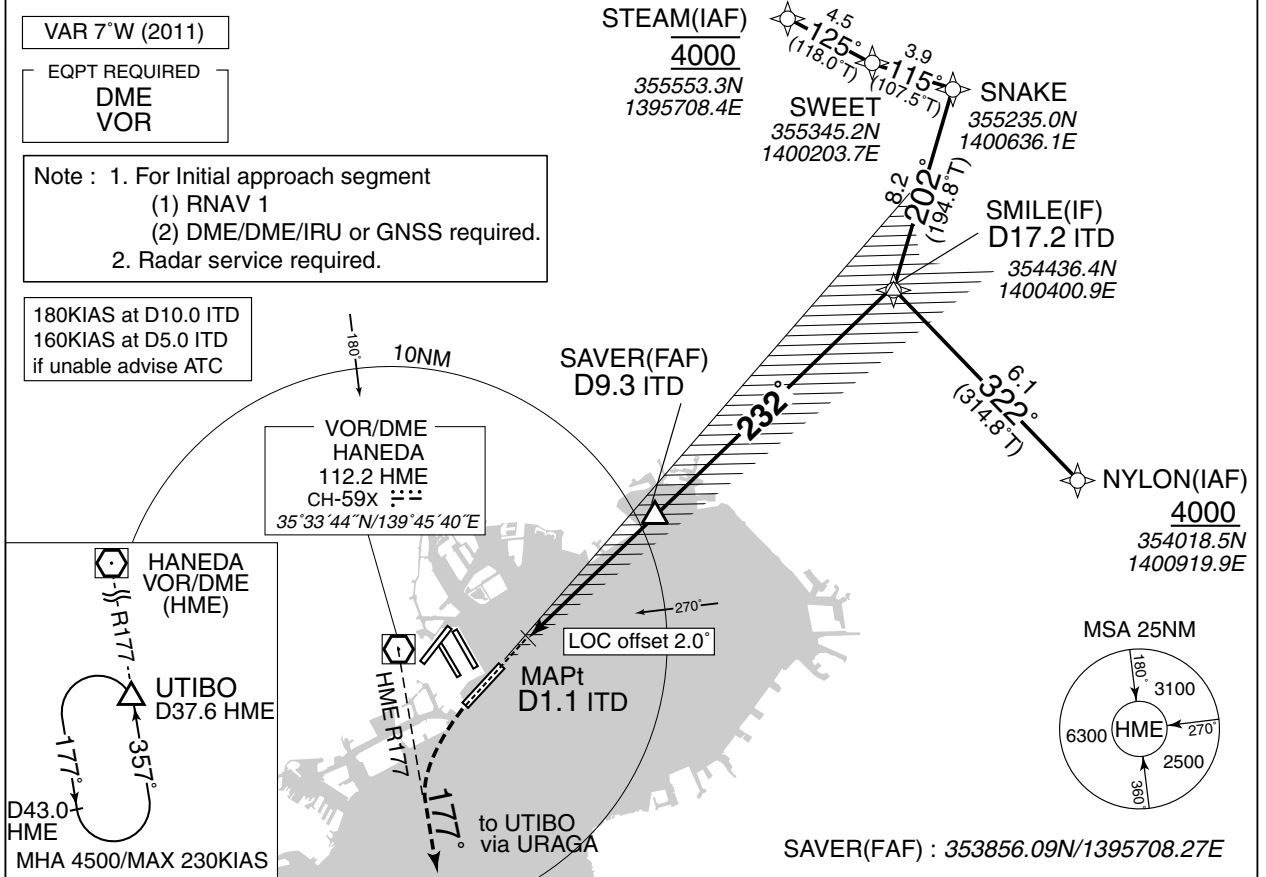

	NM to ITD	MAPt	2	3	4	5	6	7	8	9	FAF
	ALT (3.0° APCH Path)	-	683	1002	1320	1639	1957	2276	2594	2912	-

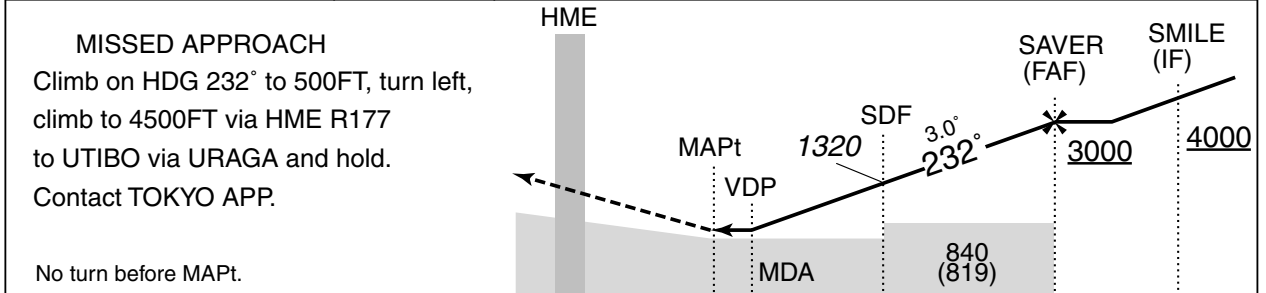

DME to ITD	0.2	1.1	1.3	4.0	9.3	17.2
NM to THR	0	0.9	1.1	3.8	9.1	17.1

MINIMA		THR elev. 55		AD elev. 21	
CAT	LOC		CIRCLING		
	MDA(H)	RVR/CMV	MDA(H)	VIS	
A	440 (419)	900	730 (709)	1600	
B		1000		2400	
C				3200	
D				1400	

Circling is not authorized during the night time, except counterclockwise circling to RWY22, RWY16R/16L and clockwise circling to RWY34R/34L.

INSTRUMENT APPROACH CHART

RJTT / TOKYO INTL

ILS Y or LOC Y RWY23

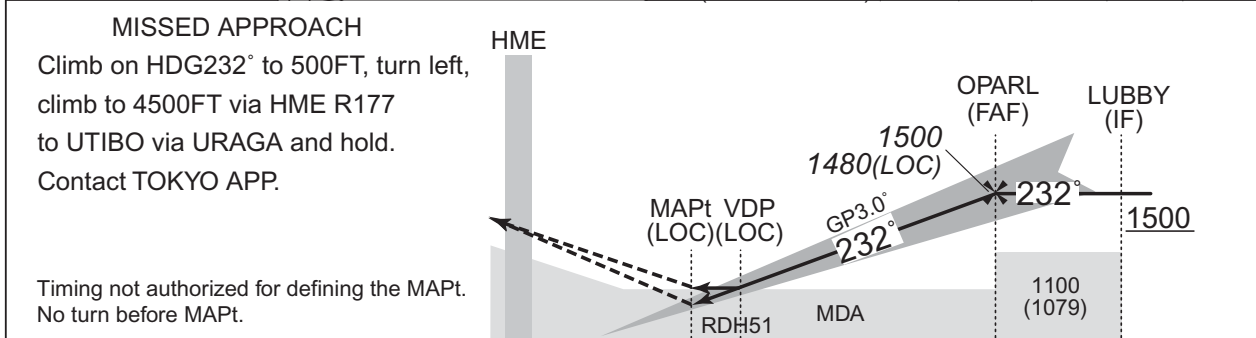
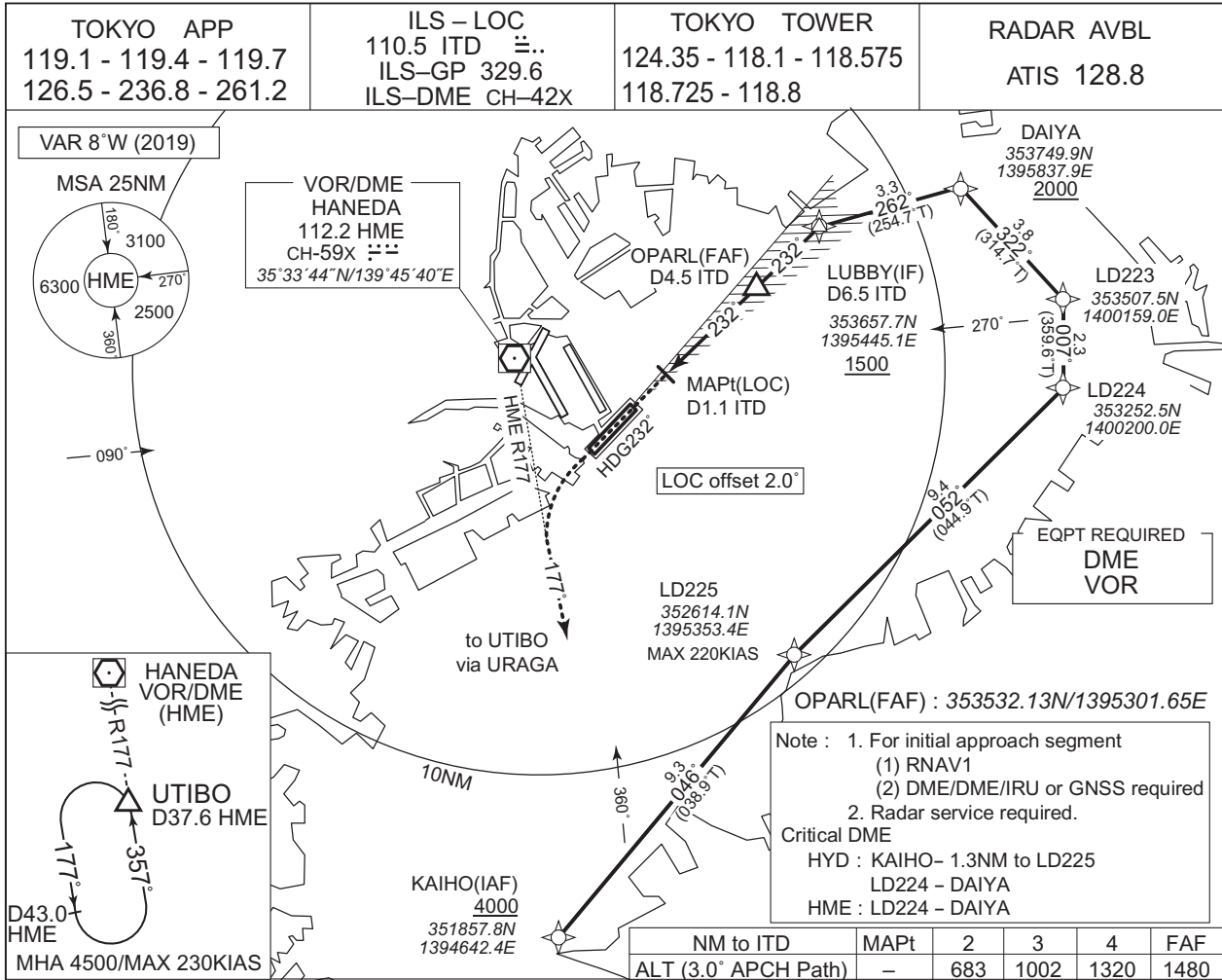

DME to ITD	0.2	1.1	1.3	4.5	6.5
NM to THR	0	0.9	1.1	4.3	6.3

MINIMA		THR elev. 55		AD elev. 21		
CAT	CAT I		LOC		CIRCLING	
	DA(H)	RVR/CMV	MDA(H)	RVR/CMV	MDA(H) VIS	
A	383 (328)	800	440 (419)	900	730 (709) 1600	
B				1000		
C				1400		2400
D						3200

Circling is not authorized during the night time, except counterclockwise circling to RWY22, RWY16R/16L and clockwise circling to RWY34R/34L.

CHANGE: Description of GP angle.

INSTRUMENT APPROACH CHART

RJTT / TOKYO INTL

LDA Z RWY23

TOKYO APP 119.1 - 119.4 - 119.7 126.5 - 236.8 - 261.2	LDA - LOC 108.5 ITL 3.. LDA-DME CH-22X	TOKYO TOWER 124.35 - 118.1 - 118.575 118.725 - 118.8	RADAR AVBL ATIS 128.8
---	--	--	--------------------------

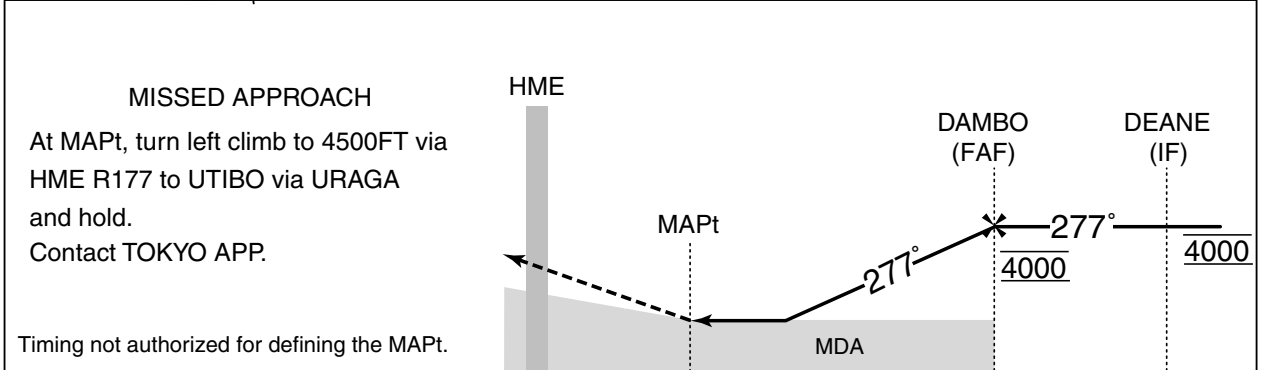
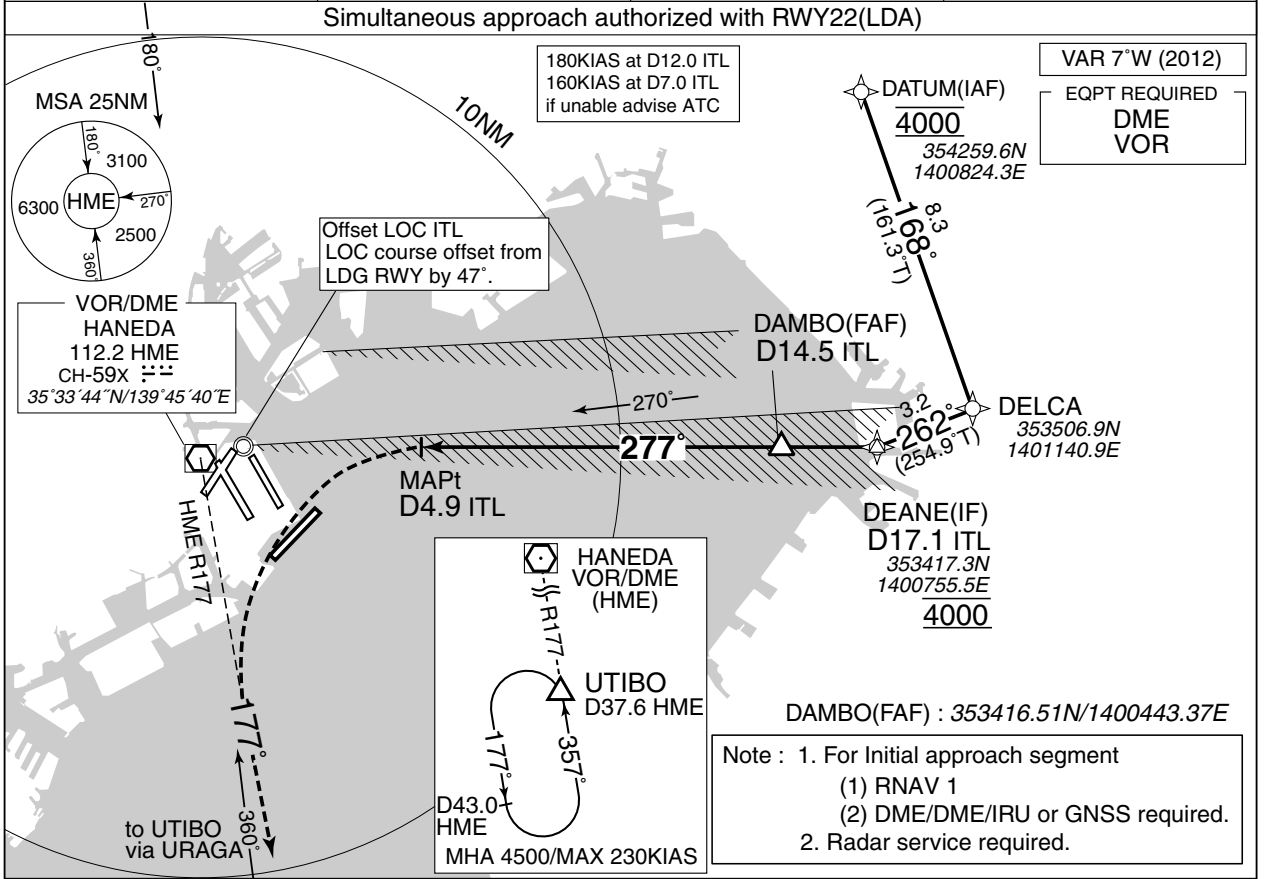

DME to ITL	4.9	14.5	17.1
NM to THR	3.4	13.0	15.6

MINIMA	THR elev. 55	AD elev. 21
CAT	MDA(H)	VIS
A	1000 (979)	6000
B		
C		
D		

MINIMA APPLICATION CRITERIA in AD1.1.6.10.1.4 are not applicable.

INSTRUMENT APPROACH CHART

RJTT / TOKYO INTL

LDA Z RWY23

Visual Prescribed Track for LDA Z RWY23

Visual manoeuvre with Prescribed Track (VPT) : VPT stands for visual maneuvering after the MAPt using prescribed track.

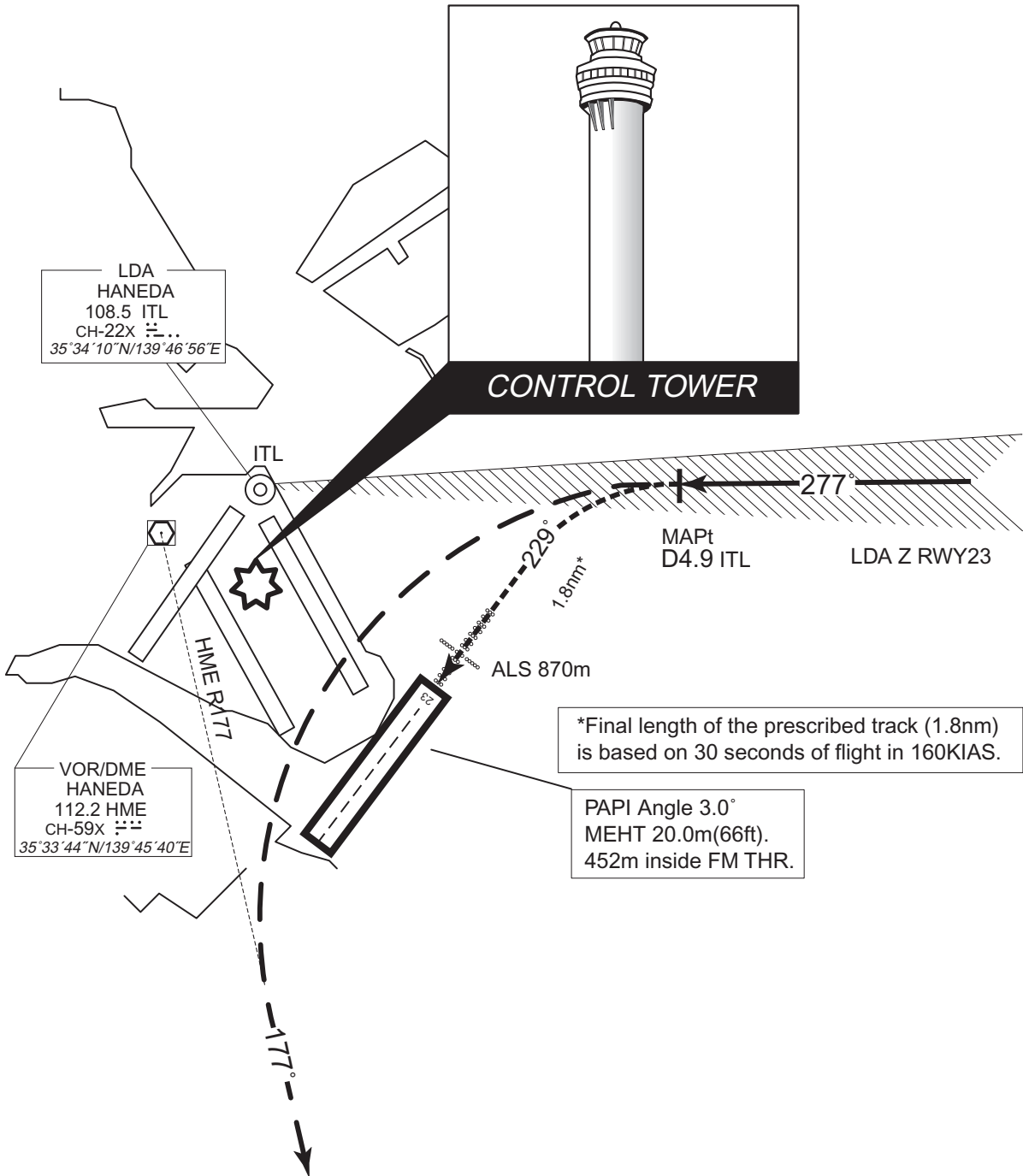

CHANGE : Correction of misdescription (ITL COORD).

In case of GO AROUND, pilot should report ATC as soon as practicable.  
Until receiving ATC instructions, aircraft turn left HDG 229° for joining HME R177 and missed approach procedure.



AERODROME OBSTACLE CHART-ICAO  
TYPE A(OPERATING LIMITATIONS)

DIMENSIONS AND ELEVATIONS IN FEET BEARINGS ARE MAGNETIC

MAGNETIC VARIATION 7°W-APR 2015

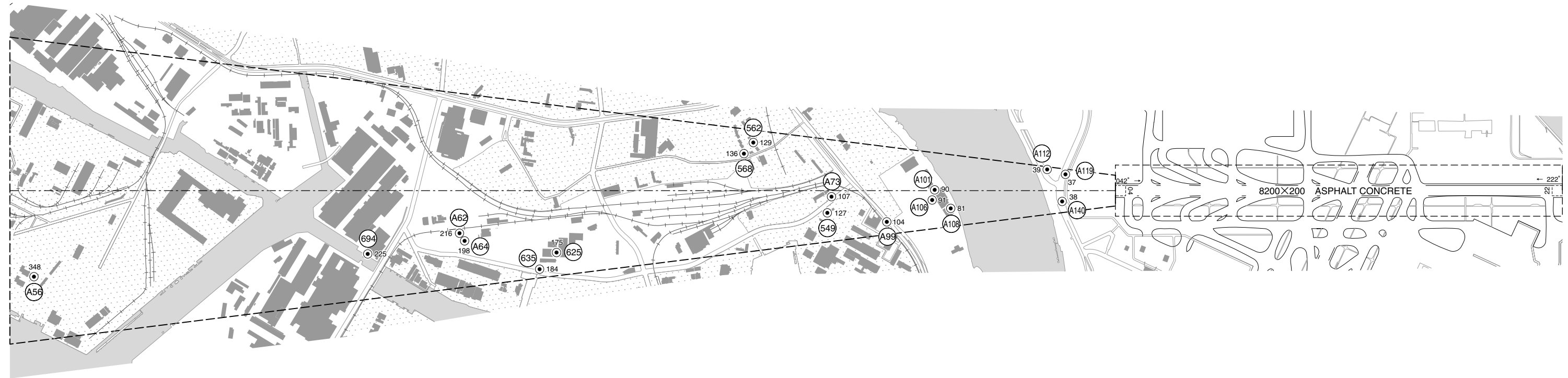
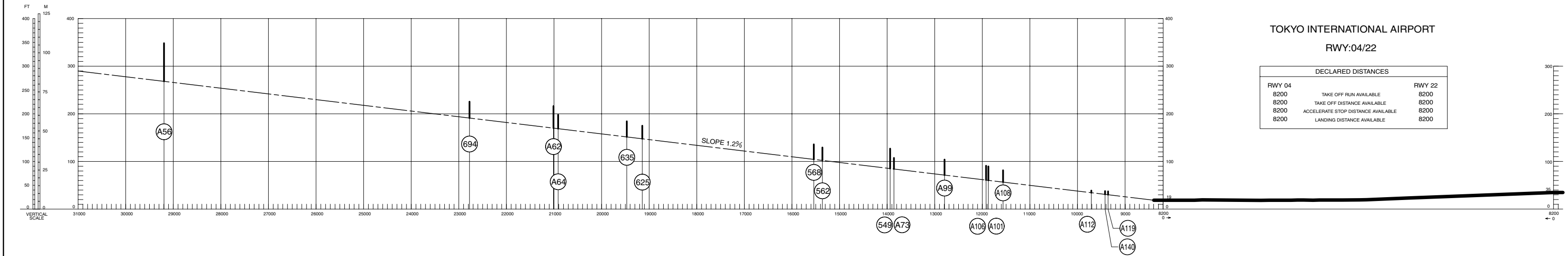

LEGEND		AMENDMENT RECORD		
		Nr	DATE	ENTERED BY
①	IDENTIFICATION NUMBER			
●	POLE, TOWER, SPIRE, ANTENNA, ETC.			
✳	TREE			
—+—	RAILROAD			
—+—	TRANSMISSION LINE OR OVERHEAD CABLE			
△	TRIANGULATION POINT			
★	AERONAUTICAL GROUND LIGHT			

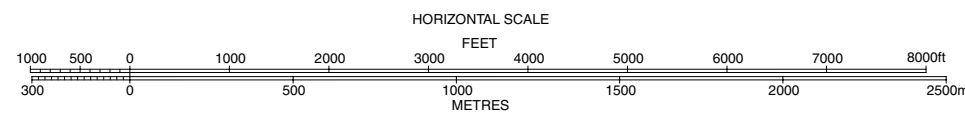

INSTRUMENT APPROACH CHART

RJTT / TOKYO INTL

LDA Y RWY23

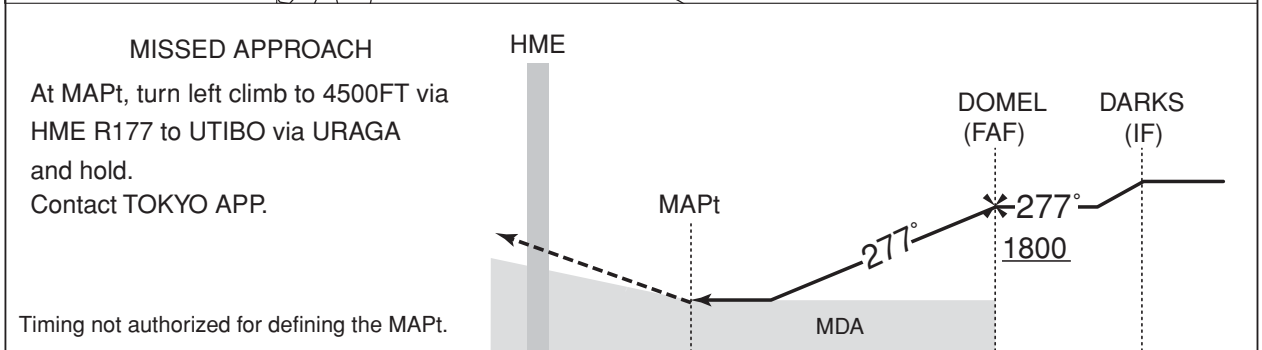
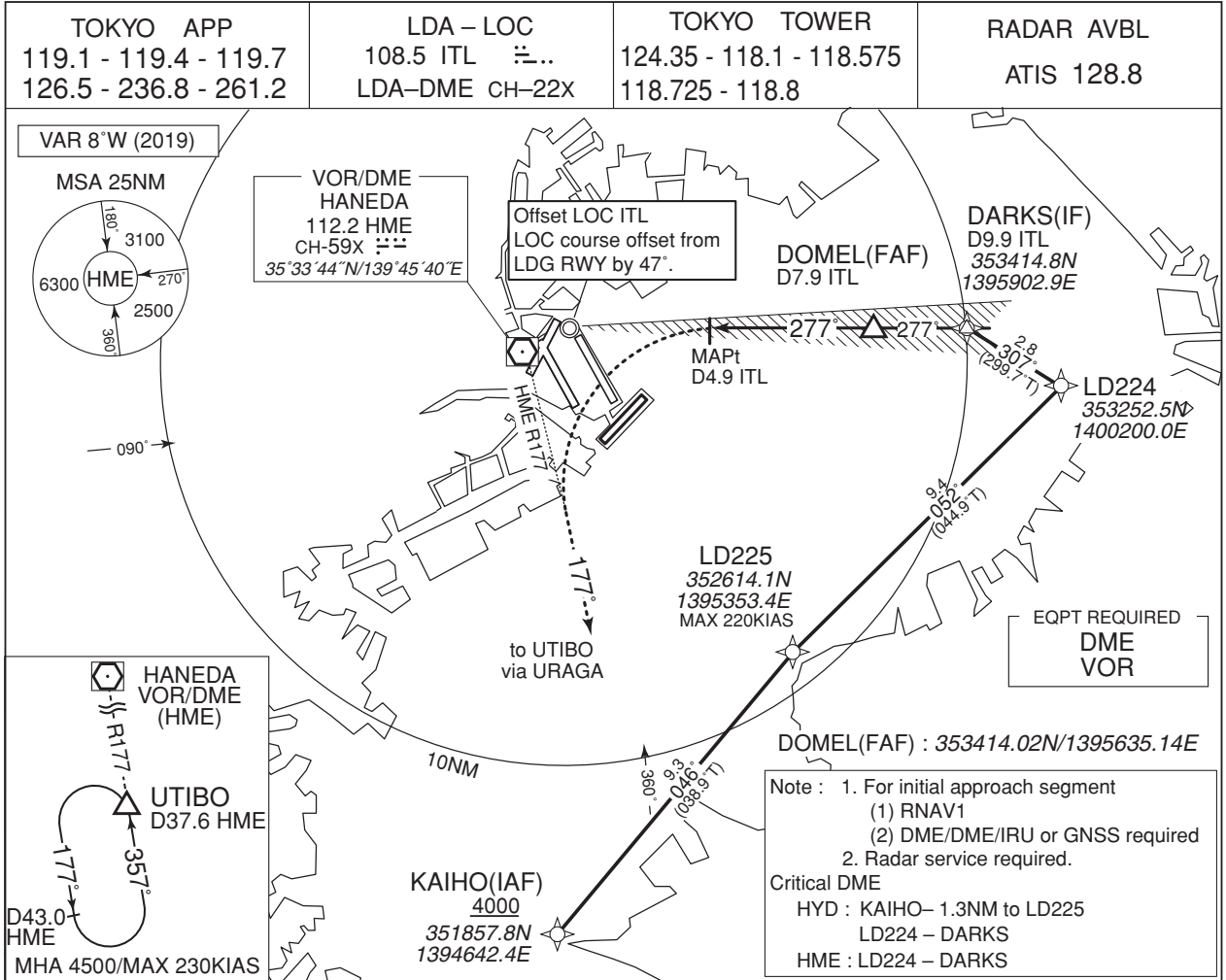

<b>DME to ITL</b>	4.9	7.9	9.9
NM to THR	3.4	6.4	8.4

<b>MINIMA</b>	<b>THR elev. 55</b>	<b>AD elev. 21</b>
<b>CAT</b>	<b>MDA(H)</b>	<b>VIS</b>
A		
B	1000 (979)	6000
C		
D		

CHANGE : Update

MINIMA APPLICATION CRITERIA in AD1.1.6.10.1.4 are not applicable.

INSTRUMENT APPROACH CHART

RJTT / TOKYO INTL

LDA Y RWY23

Visual Prescribed Track for LDA Y RWY23

Visual manoeuvre with Prescribed Track (VPT) : VPT stands for visual maneuvering after the MAPt using prescribed track.

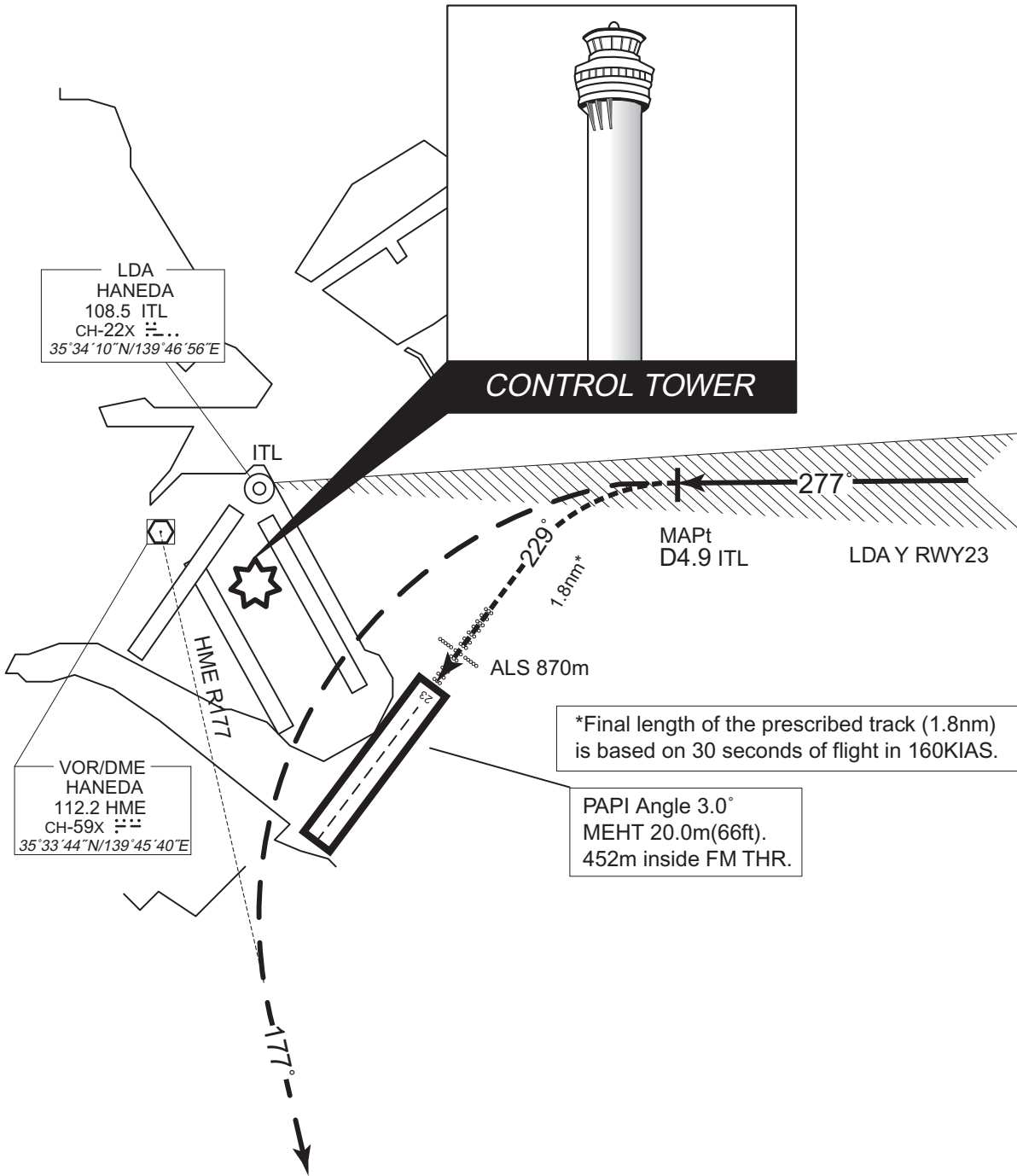

\*Final length of the prescribed track (1.8nm) is based on 30 seconds of flight in 160KIAS.

PAPI Angle 3.0°  
MEHT 20.0m(66ft).  
452m inside FM THR.

CHANGE : Correction of misdescription (ITL COORD).

In case of GO AROUND, pilot should report ATC as soon as practicable.  
Until receiving ATC instructions, aircraft turn left HDG 229° for joining HME R177 and missed approach procedure.

INSTRUMENT APPROACH CHART

RJTT / TOKYO INTL

VOR RWY34L

TOKYO APP 119.1 - 119.4 - 119.7 126.5 - 236.8 - 261.2	HANEDA VOR/DME 112.2 HME CH-59X $\equiv \equiv$ 35°33'44"N/139°45'40"E	TOKYO TOWER 118.1 - 124.35 - 118.575 118.725 - 118.8	RADAR AVBL ATIS 128.8
---	---	--	--------------------------

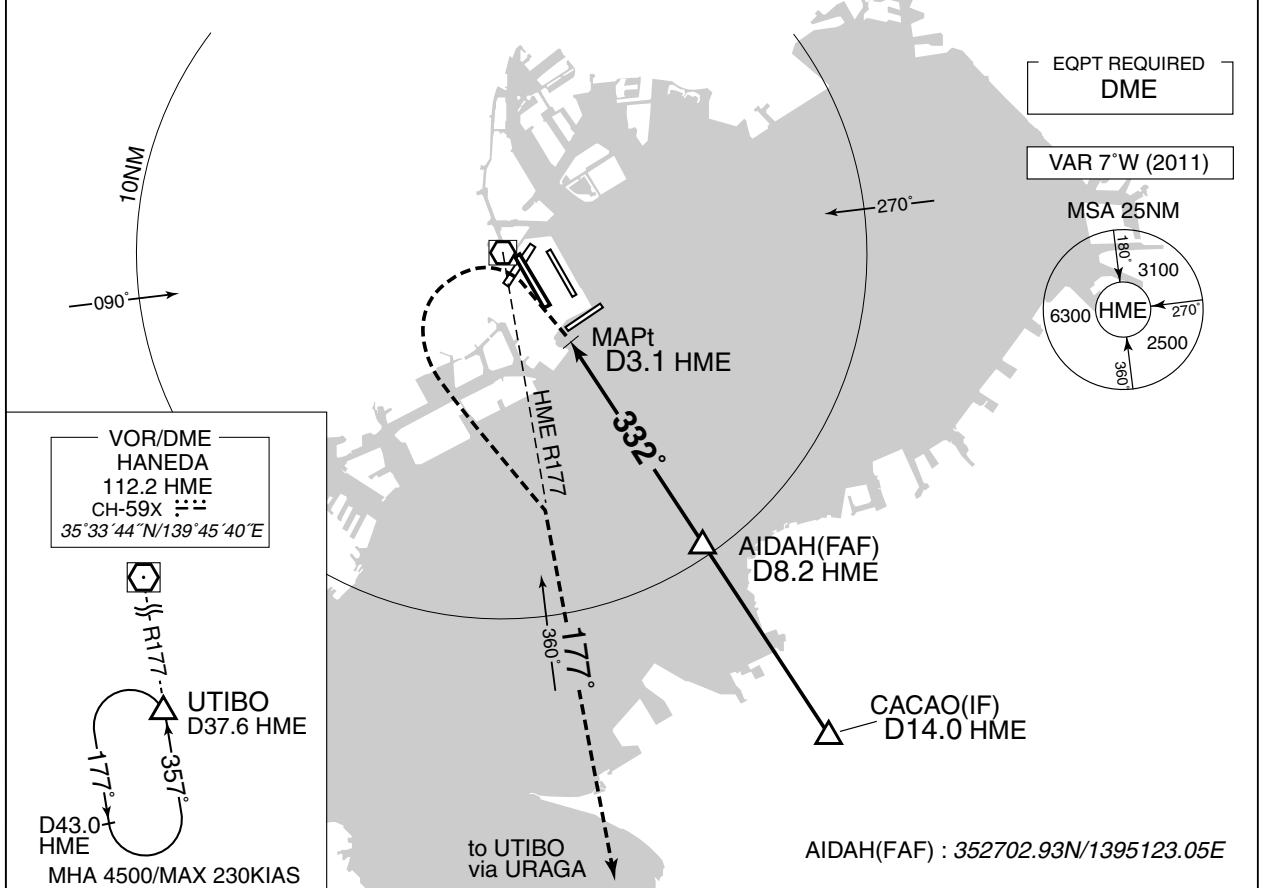

	NM to HME	MAPt	4	5	6	7	8	FAF
	ALT (3.0° APCH Path)	-	722	1041	1359	1678	1996	2043

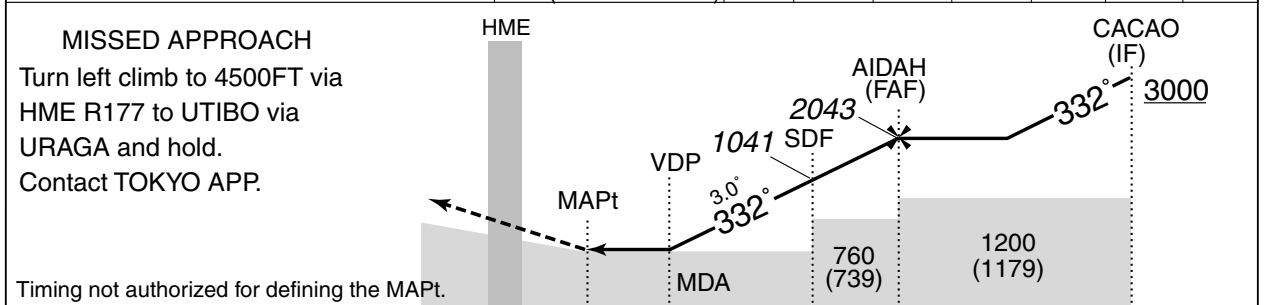

DME to HME	1.9	3.1	3.6	5.0	8.2	14.0
NM to THR	0	1.2	1.7	3.1	6.3	12.1

MINIMA		THR elev. 18		AD elev. 21					
CAT	MDA(H)		RVR/CMV		CIRCLING				
	MDA(H)		VIS						
A	580 (559)		1000		730 (709)				
B			1200			1600			
C							1600		2400
D									

INSTRUMENT APPROACH CHART

RJTT / TOKYO INTL

VOR A (for RWY16R/RWY16L)

TOKYO APP 119.1 - 119.4 - 119.7 126.5 - 236.8 - 261.2	HANEDA VOR/DME 112.2 HME CH-59X 35°33'44"N/139°45'40"E	TOKYO TOWER 124.35 - 118.1 - 118.575 118.725 - 118.8	RADAR AVBL ATIS 128.8
---	---	--	--------------------------

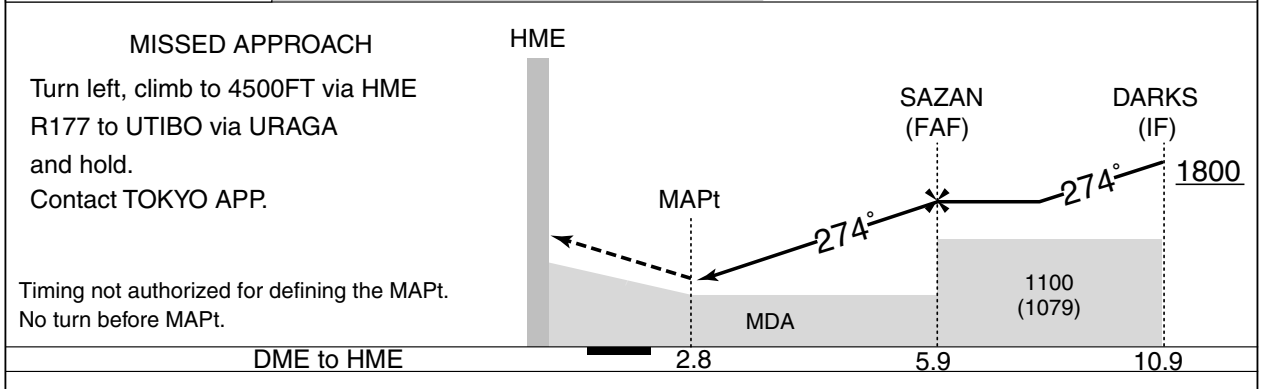
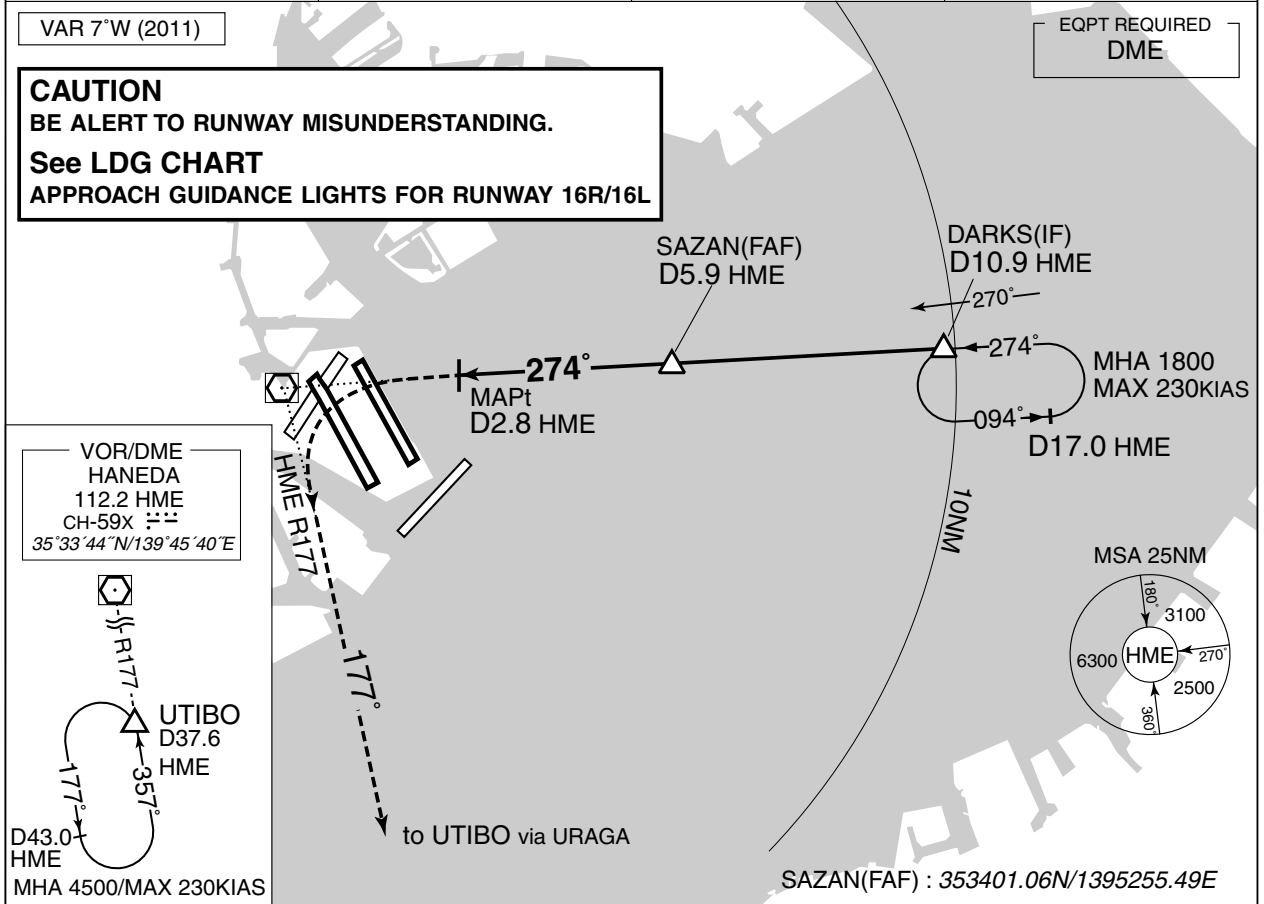

MINIMA		AD elev. 21	
CAT	CIRCLING		
	MDA(H)	VIS	
A	760 (739)	1600	
B		2400	
C			3200
D			

**INTENTIONALLY LEFT BLANK**

STANDARD ARRIVAL CHART-INSTRUMENT

RJTT / TOKYO INTL

RNAV STAR RWY34R/34L

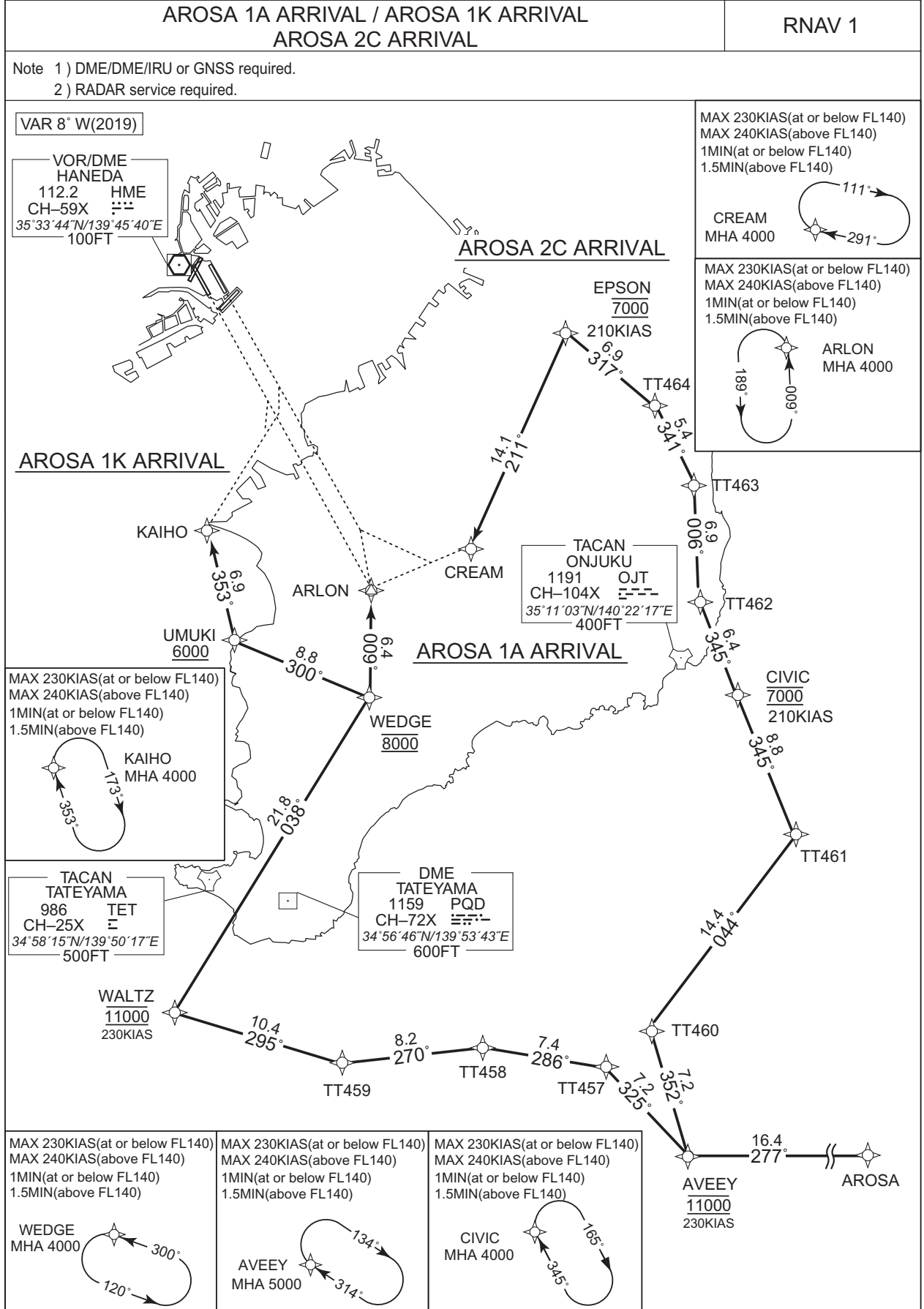

CHANGE : AVEEY renamed

## STANDARD ARRIVAL CHART-INSTRUMENT

RJTT / TOKYO INTL

RNAV STAR RWY34R/34L

AROSA 1A ARRIVAL

From AROSA, to AVEEY at 11000FT, to TT457, to TT458, to TT459, to WALTZ at 11000FT, to WEDGE at 8000FT, to ARLON.

Critical DME	-
DME GAP	-
Inappropriate Nav aids	See AD1.1.6.10.3. Inappropriate NAVAIDs for RNAV1

Serial Number	Path Descriptor	Waypoint Identifier	Fly Over	Course °M(°T)	Magnetic Variation	Distance (NM)	Turn Direction	Altitude (FT)	Speed (KIAS)	Vertical Angle	Navigation Specification
001	IF	AROSA	-	-	-7.5	-	-	-	-	-	RNAV1
002	TF	AVEEY	-	277 (269.8)	-7.5	16.4	-	11000	230	-	RNAV1
003	TF	TT457	-	325 (317.5)	-7.5	7.2	-	-	-	-	RNAV1
004	TF	TT458	-	286 (278.5)	-7.5	7.4	-	-	-	-	RNAV1
005	TF	TT459	-	270 (262.3)	-7.5	8.2	-	-	-	-	RNAV1
006	TF	WALTZ	-	295 (287.0)	-7.5	10.4	-	11000	230	-	RNAV1
007	TF	WEDGE	-	038 (030.6)	-7.5	21.8	-	8000	-	-	RNAV1
008	TF	ARLON	-	009 (001.6)	-7.5	6.4	-	-	-	-	RNAV1

Path	Waypoint Identifier	Inbound Course °M(°T)	Magnetic Variation	Outbound Time (MIN)	Outbound Distance (NM)	Turn Direction	Minimum Altitude (FT)	Maximum Altitude (FT)	Speed (KIAS)	Navigation Specification
Hold	AVEEY	314 (306.1)	-7.5	1.0(-14000) 1.5(+14001)	-	R	5000	-	-230(-14000) -240(+14001)	RNAV1
Hold	WEDGE	300 (292.4)	-7.5	1.0(-14000) 1.5(+14001)	-	L	4000	-	-230(-14000) -240(+14001)	RNAV1
Hold	ARLON	009 (001.6)	-7.5	1.0(-14000) 1.5(+14001)	-	L	4000	-	-230(-14000) -240(+14001)	RNAV1

CHANGE : AVEEY renamed



STANDARD ARRIVAL CHART-INSTRUMENT

RJTT / TOKYO INTL

RNAV STAR RWY34R/34L

AROSA 1K ARRIVAL

From AROSA, to AVEEY at 11000FT, to TT457, to TT458, to TT459, to WALTZ at 11000FT, to WEDGE at 8000FT, to UMUKI at or above 6000FT, to KAIHO.

Critical DME	-
DME GAP	-
Inappropriate Nav aids	See AD1.1.6.10.3. Inappropriate NAVAIDs for RNAV1

Serial Number	Path Descriptor	Waypoint Identifier	Fly Over	Course °M(°T)	Magnetic Variation	Distance (NM)	Turn Direction	Altitude (FT)	Speed (KIAS)	Vertical Angle	Navigation Specification
001	IF	AROSA	-	-	-7.5	-	-	-	-	-	RNAV1
002	TF	AVEEY	-	277 (269.8)	-7.5	16.4	-	11000	230	-	RNAV1
003	TF	TT457	-	325 (317.5)	-7.5	7.2	-	-	-	-	RNAV1
004	TF	TT458	-	286 (278.5)	-7.5	7.4	-	-	-	-	RNAV1
005	TF	TT459	-	270 (262.3)	-7.5	8.2	-	-	-	-	RNAV1
006	TF	WALTZ	-	295 (287.0)	-7.5	10.4	-	11000	230	-	RNAV1
007	TF	WEDGE	-	038 (030.6)	-7.5	21.8	-	8000	-	-	RNAV1
008	TF	UMUKI	-	300 (292.2)	-7.5	8.8	-	+6000	-	-	RNAV1
009	TF	KAIHO	-	353 (345.5)	-7.5	6.9	-	-	-	-	RNAV1

Path	Waypoint Identifier	Inbound Course °M(°T)	Magnetic Variation	Outbound Time (MIN)	Outbound Distance (NM)	Turn Direction	Minimum Altitude (FT)	Maximum Altitude (FT)	Speed (KIAS)	Navigation Specification
Hold	AVEEY	314 (306.1)	-7.5	1.0(-14000) 1.5(+14001)	-	R	5000	-	-230(-14000) -240(+14001)	RNAV1
Hold	WEDGE	300 (292.4)	-7.5	1.0(-14000) 1.5(+14001)	-	L	4000	-	-230(-14000) -240(+14001)	RNAV1
Hold	KAIHO	353 (345.5)	-7.5	1.0(-14000) 1.5(+14001)	-	R	4000	-	-230(-14000) -240(+14001)	RNAV1

CHANGE : AVEEY renamed

STANDARD ARRIVAL CHART-INSTRUMENT

RJTT / TOKYO INTL

RNAV STAR RWY34R/34L

AROSA 2C ARRIVAL

From AROSA, to AVEEY at 11000FT, to TT460, to TT461, to CIVIC at 7000FT, to TT462, to TT463, to TT464, to EPSON at 7000FT, to CREAM.

Critical DME	-
DME GAP	-
Inappropriate Nav aids	See AD1.1.6.10.3. Inappropriate NAVAIDs for RNAV1

Serial Number	Path Descriptor	Waypoint Identifier	Fly Over	Course °M(°T)	Magnetic Variation	Distance (NM)	Turn Direction	Altitude (FT)	Speed (KIAS)	Vertical Angle	Navigation Specification
001	IF	AROSA	-	-	-7.5	-	-	-	-	-	RNAV1
002	TF	AVEEY	-	277 (269.8)	-7.5	16.4	-	11000	230	-	RNAV1
003	TF	TT460	-	352 (344.5)	-7.5	7.2	-	-	-	-	RNAV1
004	TF	TT461	-	044 (036.1)	-7.5	14.4	-	-	-	-	RNAV1
005	TF	CIVIC	-	345 (337.7)	-7.5	8.8	-	7000	210	-	RNAV1
006	TF	TT462	-	345 (337.7)	-7.5	6.4	-	-	-	-	RNAV1
007	TF	TT463	-	006 (358.0)	-7.5	6.9	-	-	-	-	RNAV1
008	TF	TT464	-	341 (333.5)	-7.5	5.4	-	-	-	-	RNAV1
009	TF	EPSON	-	317 (309.0)	-7.5	6.9	-	7000	210	-	RNAV1
010	TF	CREAM	-	211 (203.6)	-7.5	14.1	-	-	-	-	RNAV1

Path	Waypoint Identifier	Inbound Course °M(°T)	Magnetic Variation	Outbound Time (MIN)	Outbound Distance (NM)	Turn Direction	Minimum Altitude (FT)	Maximum Altitude (FT)	Speed (KIAS)	Navigation Specification
Hold	AVEEY	314 (306.1)	-7.5	1.0(-14000) 1.5(+14001)	-	R	5000	-	-230(-14000) -240(+14001)	RNAV1
Hold	CIVIC	345 (337.7)	-7.5	1.0(-14000) 1.5(+14001)	-	R	4000	-	-230(-14000) -240(+14001)	RNAV1
Hold	CREAM	291 (283.1)	-7.5	1.0(-14000) 1.5(+14001)	-	R	4000	-	-230(-14000) -240(+14001)	RNAV1

Waypoint Coordinates

Waypoint Identifier	Coordinates	Waypoint Identifier	Coordinates
ARLON	351525.3N / 1395859.8E	TT459	344712.8N / 1395716.3E
AROSA	344201.7N / 1404157.3E	TT460	344852.6N / 1401936.8E
AVEEY	344155.9N / 1402158.0E	TT461	350030.2N / 1402957.9E
CIVIC	350840.6N / 1402552.1E	TT462	351433.3N / 1402254.8E
CREAM	351743.4N / 1400612.4E	TT463	352125.4N / 1402237.1E
EPSON	353036.2N / 1401305.9E	TT464	352617.6N / 1401938.6E
KAIHO	351857.8N / 1394642.4E	UMUKI	351219.1N / 1394849.2E
TT457	344714.3N / 1401602.7E	WALTZ	345014.4N / 1394510.7E
TT458	344819.1N / 1400710.5E	WEDGE	350900.4N / 1395846.5E

CHANGE : AVEEY renamed

**VISUAL APPROACH  
HIGHWAY VISUAL RWY34R**

RJTT / TOKYO INTL

TOKYO APP 119.1 - 119.4 - 119.7 126.5 - 236.8 - 261.2	ILS - LOC ITC 108.9 ILS-GP 329.3	TOKYO TOWER 124.35 - 118.1 - 118.575 118.725 - 118.8	ATIS 128.8
---	--	--	------------

Simultaneous approach authorized with RWY34L

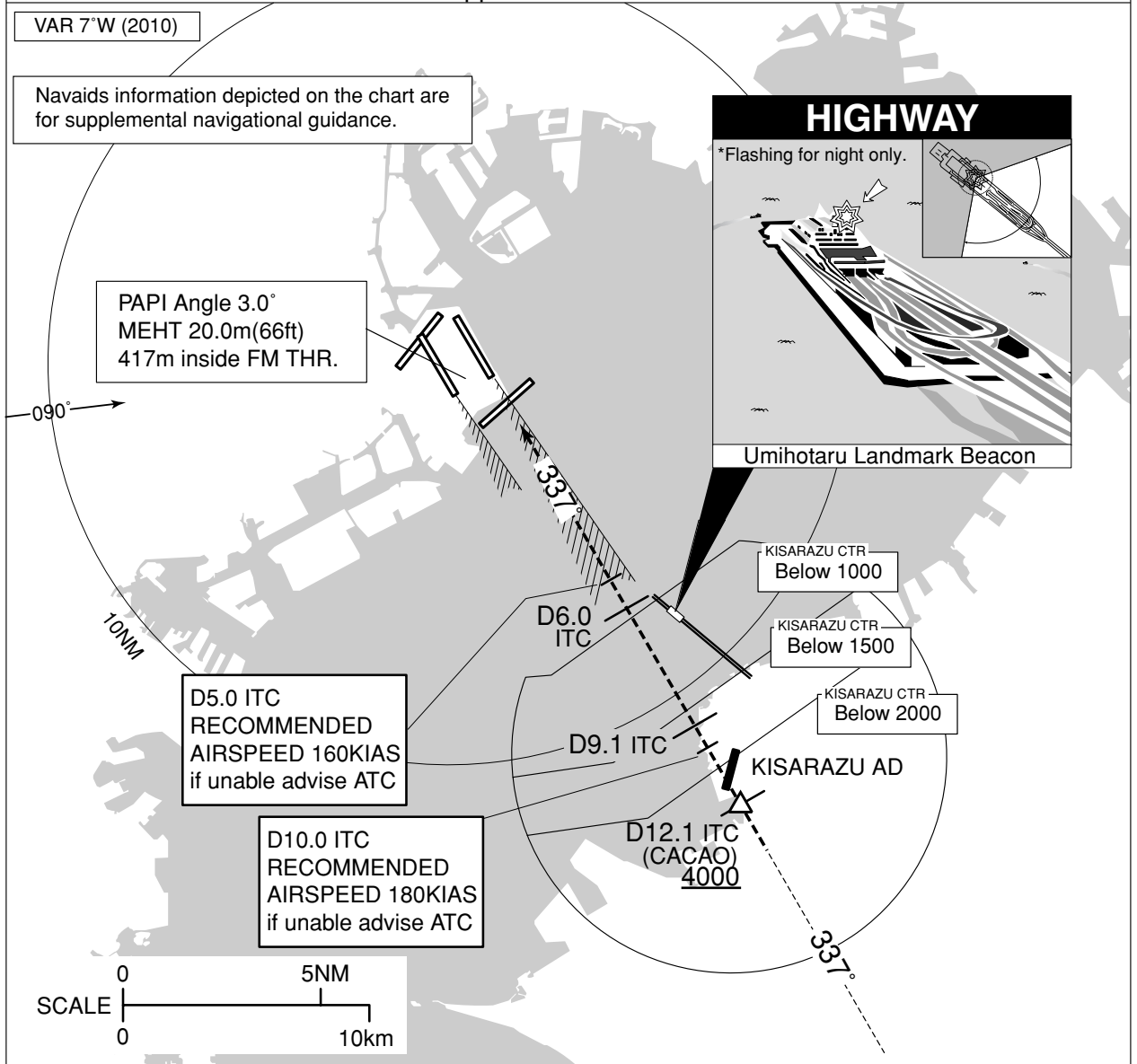

When visual approaches to RWY34R are in progress, arriving aircraft may be vectored to CACAO for HIGHWAY VISUAL RWY34R APPROACH.  
In the event of a go-around, climb via ITC LOC and after THR HDG030° to 3000FT until receiving ATC instructions.

<HIGHWAY VISUAL RWY34R APPROACH>  
After CACAO, aircraft proceed to RWY34R (ITC LOC course).  
For avoid entering KISARAZU CTR, aircraft is recommended ITC 9.1DME at or above 2500FT, ITC 6.0DME at or above 1500FT.

Note1: Pilot is urged to report promptly to ATC when lose sight of landmark(HIGHWAY) and the preceding aircraft concerned.  
Note2: Reference NAVAIDS(ITC LOC) must be operating.  
Note3: RADAR service required.  
Note4: Procedure not authorized at night in case of Umihotaru Landmark Beacon not operated.  
Note5: When cleared HIGHWAY VISUAL RWY34R APPROACH, aircraft should fly via last routing cleared until CACAO.

RJTT / TOKYO INTL

HLDG PATTERN

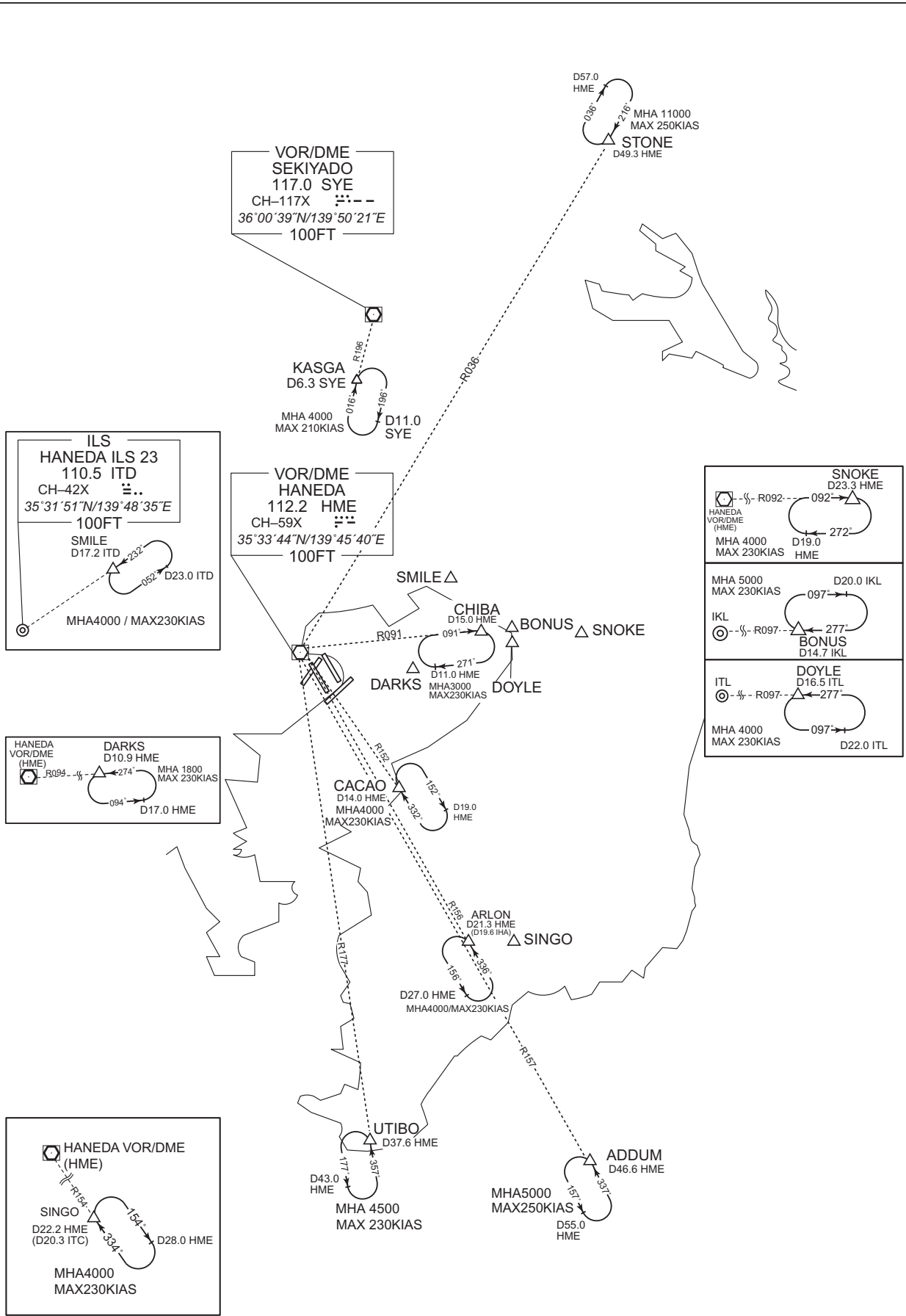

CHANGE : SNOKE established



RJTT / TOKYO INTL

Visual REP

CHANGE : MATSUDO abolished. TAMAGAWAOHASHI established.

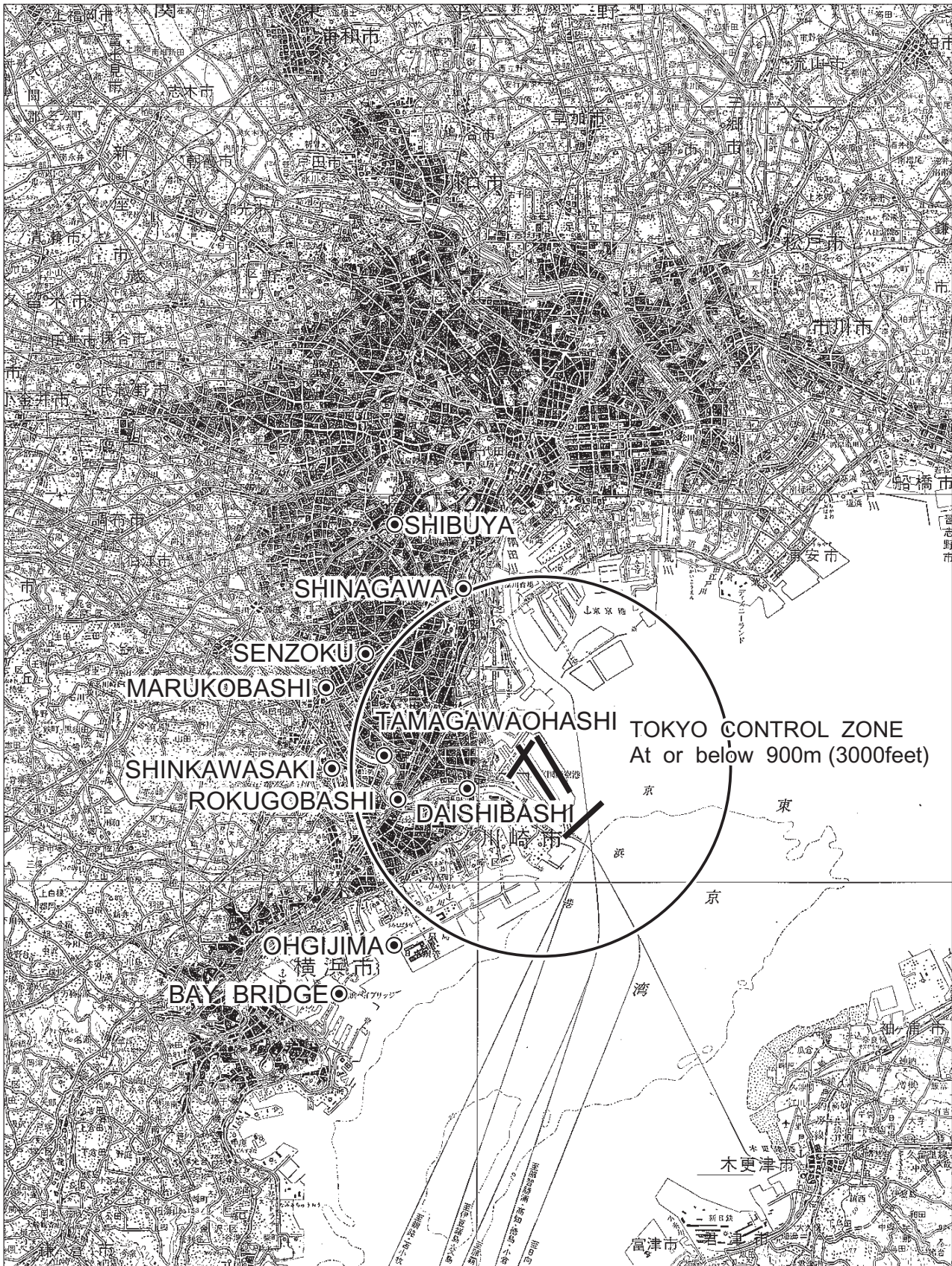

RJTT / TOKYO INTL

Visual REP

Call sign	BRG/DIST from ARP	Remarks
品川 Shinagawa	353°/5.0NM	JR駅 JR Station
洗足 Senzoku	311°/5.2NM	池 Pond
扇島 Ohgijima	225°/5.9NM	扇島の西端 West edge of the island
大師橋 Daishibashi	257°/1.9NM	橋 Bridge
六郷橋 Rokugobashi	261°/3.6NM	橋 Bridge
新川崎 Shinkawasaki	276°/5.3NM	JR駅 JR Station
丸子橋 Marukobashi	296°/5.7NM	橋 Bridge
渋谷 Shibuya	336°/7.3NM	JR駅 JR Station
ベイブリッジ Bay Bridge	227°/8.0NM	(首都高速湾岸線)橋 Bridge
多摩川大橋 Tamagawaohashi	280°/4.2NM	橋 Bridge

CHANGE: MATSUDO abolished. TAMAGAWAOHASHI established.



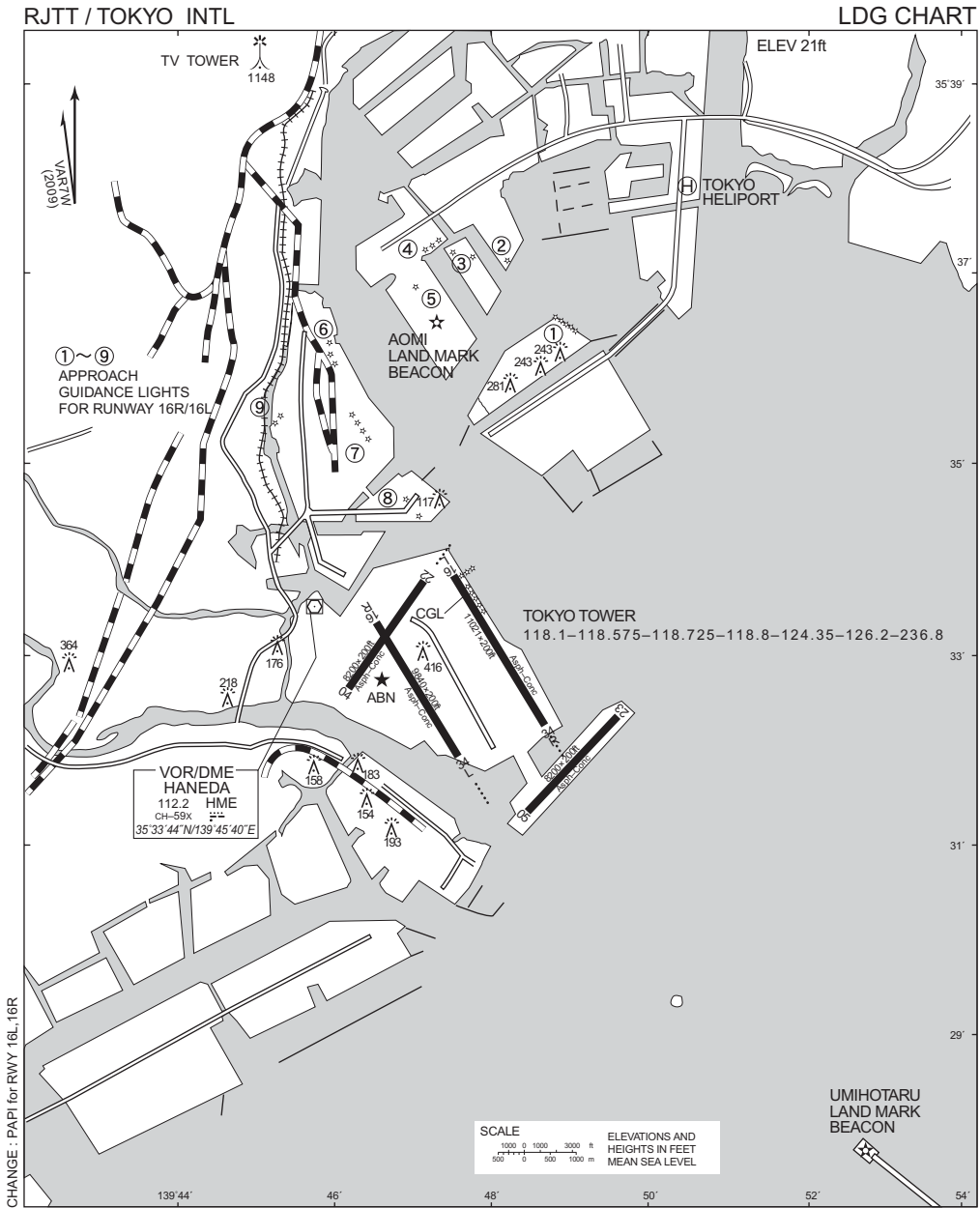

**PAPI:**

- RWY 16L-3.0°, MEHT 19.9m (65ft)  
412m inside from THR.
- RWY 34R-3.0°, MEHT 20.0m (66ft)  
416m inside from THR.
- RWY 16R-3.0°, MEHT 19.9m (65ft)  
432m inside from THR.
- RWY 34L-3.0°, MEHT 20.0m (66ft)  
449m inside from THR.
- RWY 04-3.0°, MEHT 18.5m (61ft)  
369m inside from THR.
- RWY 22-3.0°, MEHT 19.5m (63ft)  
438m inside from THR.
- RWY 23-3.0°, MEHT 20.0m (66ft)  
452m inside from THR.

**RWY Grooving :**

- RWY 16L/34R 3360m X 40m
- RWY 16R/34L 3000m X 40m
- RWY 04/22 2500m X 40m
- RWY 05/23 2500m X 40m

**INTENTIONALLY LEFT BLANK**



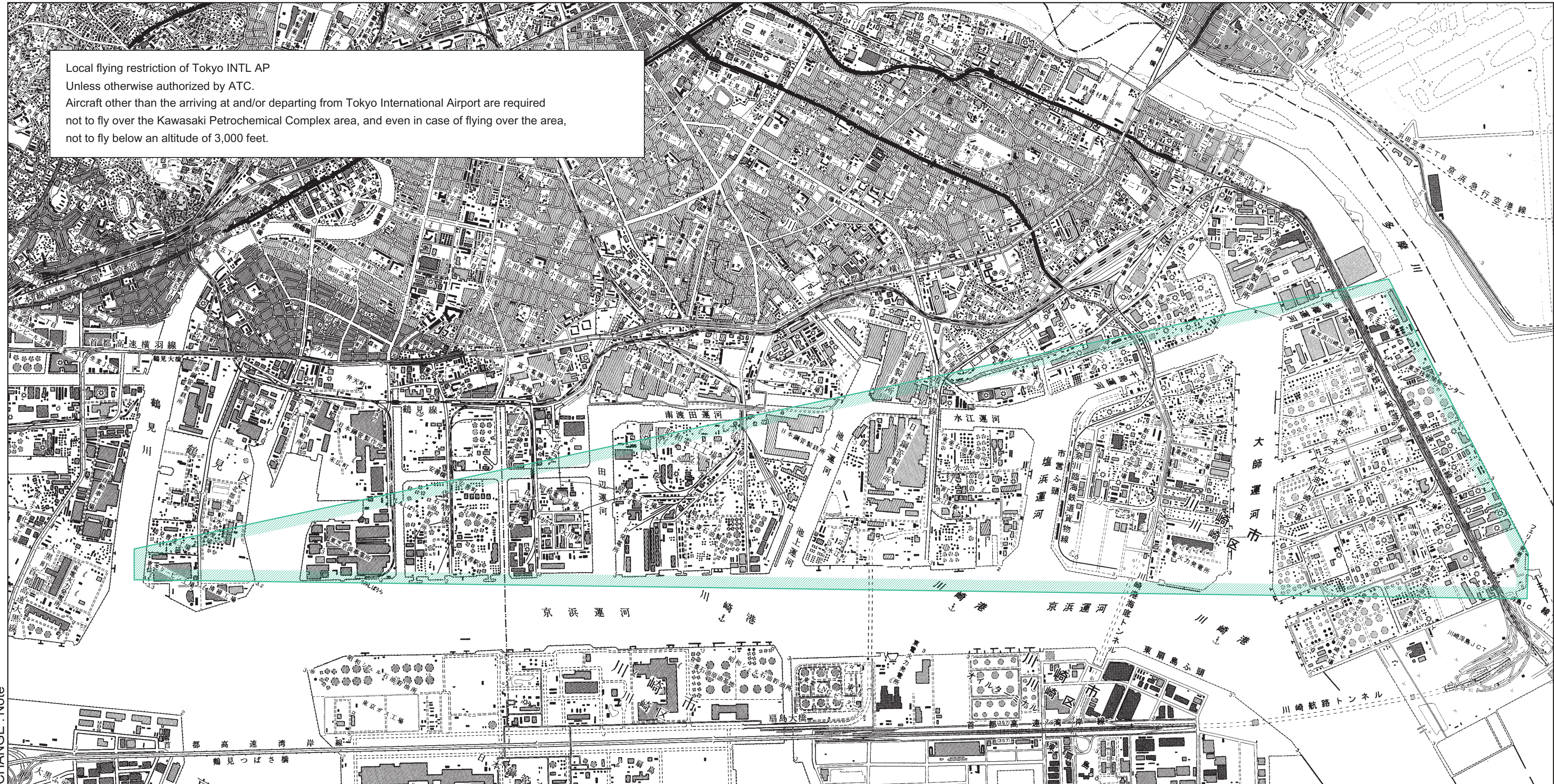

CHANGE : Note



INSTRUMENT APPROACH CHART

RJTT / TOKYO INTL

RNAV (RNP) RWY23

TOKYO APP 119.1 - 119.4 - 119.7 126.5 - 236.8 - 261.2	GNSS and RF required.	TOKYO TOWER 124.35 - 118.1 - 118.575 118.725 - 118.8	RADAR AVBL ATIS 128.8
---	-----------------------	--	--------------------------

For uncompensated Baro-VNAV systems, procedure not authorized below 0°C / above 45°C.

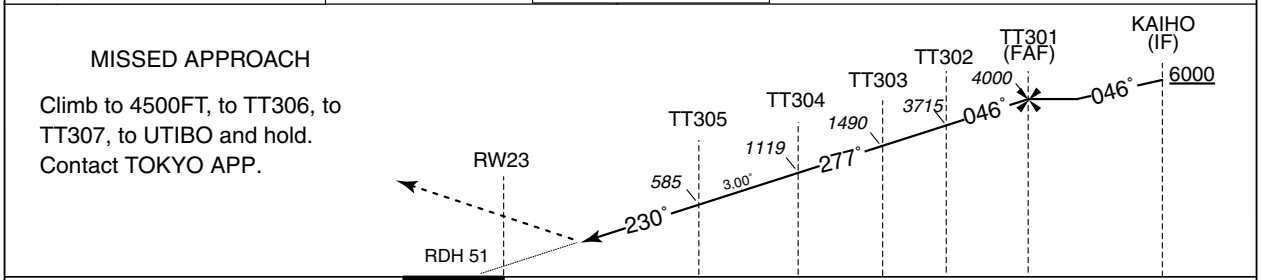
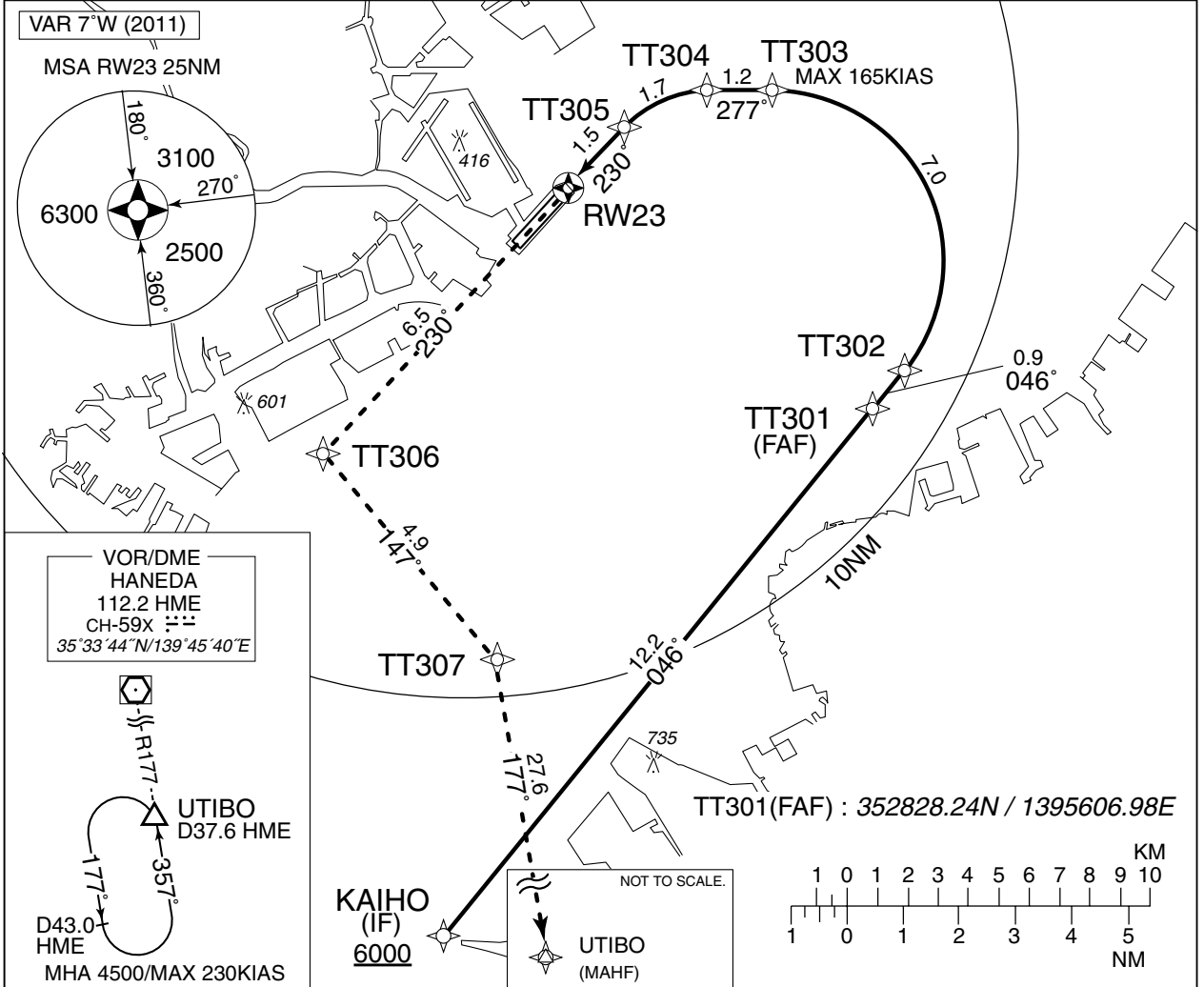

MISSED APCH climb gradient MNM 5.0%		
MINIMA THR elev. 55 AD elev. 21		
CAT	RNP 0.30	
	DA(H)	RVR/CMV
A	—	—
B	—	—
C	330(275)	800
D	—	1200

**RNP AR**  
Special Authorization Required

MINIMA with Missed APCH climb gradient of 2.5% are not established.

## INSTRUMENT APPROACH CHART

RJTT / TOKYO INTL

RNAV (RNP) RWY23

RNAV (RNP) RWY23Coding Table

Serial Number	Path Descriptor	Waypoint Identifier	Fly over	Course [°M(°T)]	Magnetic Variation	Distance (NM)	Turn Direction	Altitude (FT)	Speed (KT)	VPA/RDH (°/FT)	RNP Value
001	IF	KAIHO	—	—	-7.2	—	—	+6000	—	—	—
002	TF	TT301	—	046 (038.8)	-7.2	12.2	—	4000	—	—	1.0
003	TF	TT302	—	046 (038.8)	-7.2	0.9	—	3715	—	-3.00	0.3
004	RF Center: TTRF1 r=3.10NM	TT303	—	—	-7.2	7.0	L	1490	-165	-3.00	0.3
005	TF	TT304	—	277 (269.6)	-7.2	1.2	—	1119	—	-3.00	0.3
006	RF Center: TTRF2 r=2.00NM	TT305	—	—	-7.2	1.7	L	585	—	-3.00	0.3
007	TF	RW23	Y	230 (222.5)	-7.2	1.5	—	106	—	-3.00/51	0.3
008	TF	TT306	—	230 (222.5)	-7.2	6.5	—	—	—	—	1.0
009	TF	TT307	—	147 (139.9)	-7.2	4.9	—	—	—	—	1.0
010	TF	UTIBO	—	177 (169.9)	-7.2	27.6	—	4500	—	—	1.0

Waypoint Coordinates

Waypoint Identifier	Coordinates	RF Arc Center Identifier	Coordinates
KAIHO	351857.83N / 1394642.43E	TTRF1	353106.44N / 1395349.88E
TT301	352828.24N / 1395606.98E	TTRF2	353212.62N / 1395225.48E
TT302	352909.99N / 1395647.99E		
TT303	353413.28N / 1395350.00E		
TT304	353412.77N / 1395224.45E		
TT305	353332.98N / 1395034.74E		
RW23	353226.15N / 1394919.61E		
TT306	352740.05N / 1394357.98E		
TT307	352356.01N / 1394749.03E		
UTIBO	345647.02N / 1395343.90E		

AERODROME OBSTACLE CHART-ICAO  
TYPE A (OPERATING LIMITATIONS)

DIMENSIONS AND ELEVATIONS IN FEET BEARINGS ARE MAGNETIC

MAGNETIC VARIATION 7°W-APR 2015

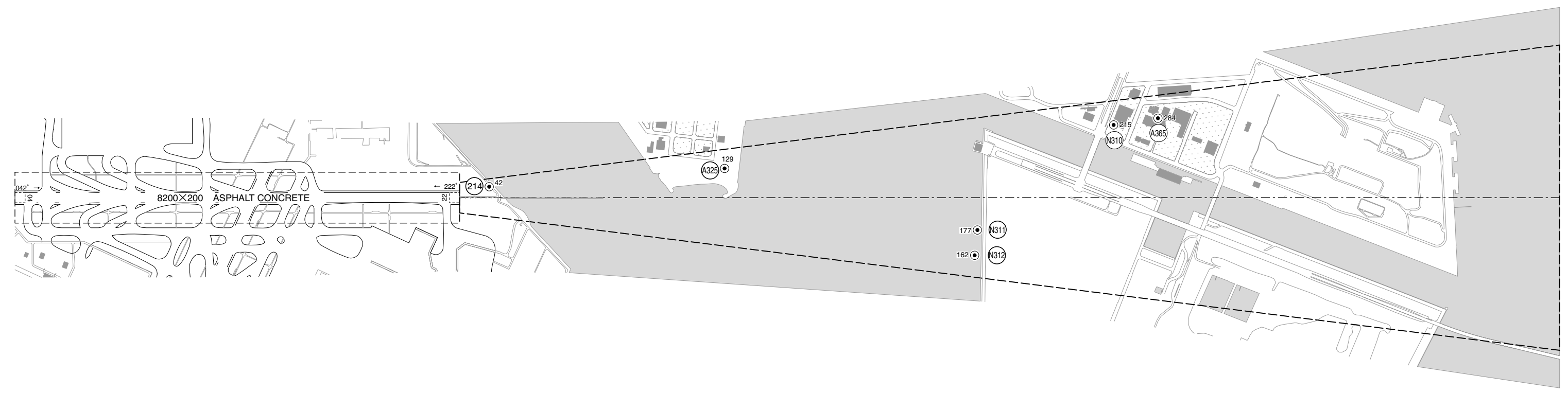
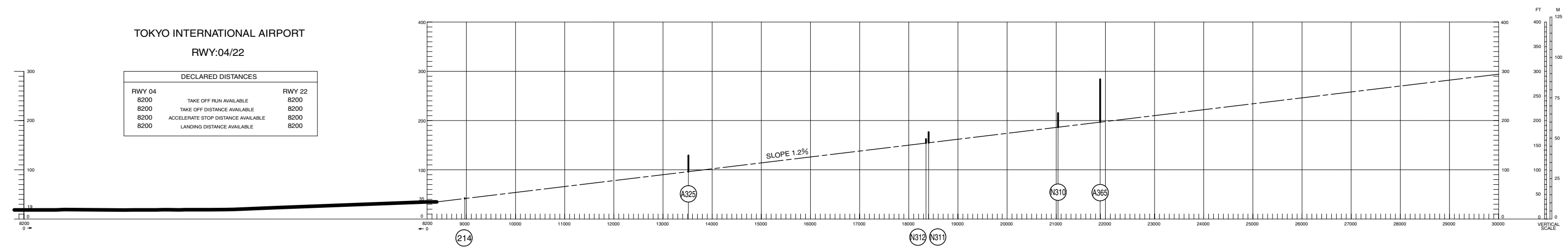

LEGEND		AMENDMENT RECORD		
		Nr	DATE	ENTERED BY
①	IDENTIFICATION NUMBER			
●	POLE, TOWER, SPIRE, ANTENNA, ETC.			
✳	TREE			
—+—	RAILROAD			
—+—	RIVER			
—+—	TRANSMISSION LINE OR OVERHEAD CABLE			
△	TRIANGULATION POINT			
★	AERONAUTICAL GROUND LIGHT			

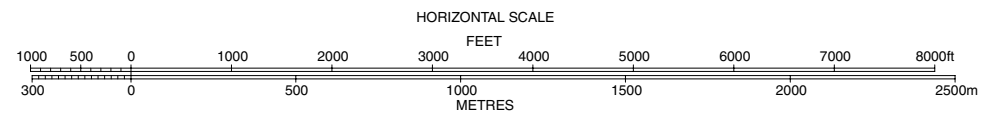

INSTRUMENT APPROACH CHART

RJTT / TOKYO INTL

LDA W RWY22

TOKYO APP 119.1 - 119.4 - 119.7 126.5 - 236.8 - 261.2	LDA - LOC 110.1 IKL LDA-DME CH-38X	TOKYO TOWER 118.575 - 118.1 - 124.35 118.725 - 118.8	RADAR AVBL ATIS 128.8
---	--	--	--------------------------

Simultaneous approach authorized with RWY23(LDA)

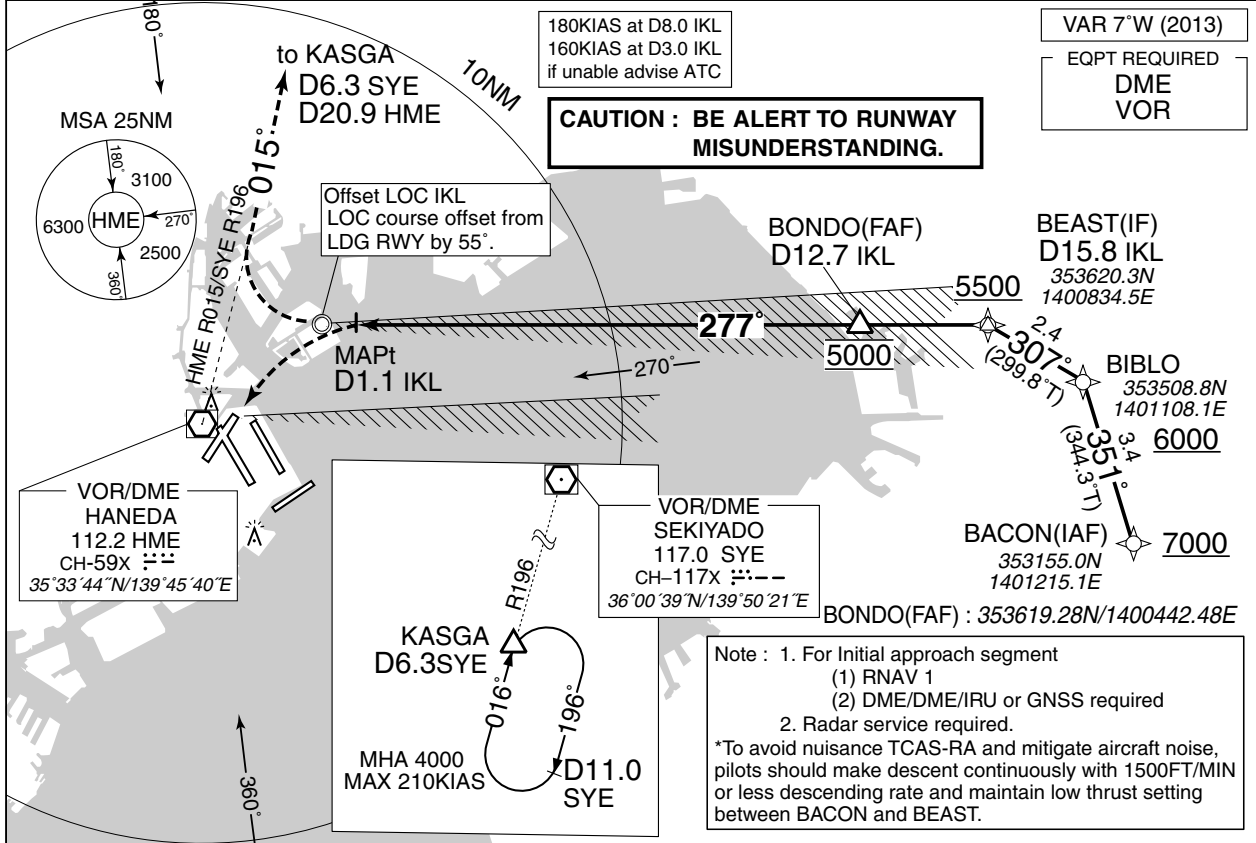

MISSED APPROACH

At MAPt, turn right climb to 4000FT via HME R015 /SYE R196 to KASGA and hold.  
Contact TOKYO APP.

Timing not authorized for defining the MAPt.

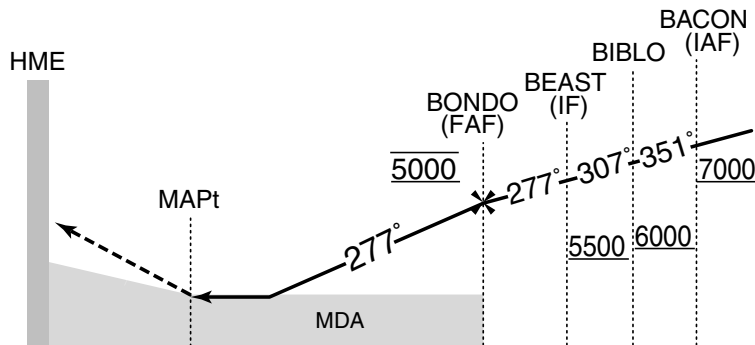

DME to IKL	1.1	12.7	15.8		
NM to THR	3.8	15.4	18.5	20.9	24.3

Missed APCH climb gradient MNM 4.0%

MINIMA	THR elev. 35	AD elev. 21
CAT	MDA(H)	VIS
A	1000 (979)	6000
B		
C		
D		

**Do Not turn left  
until D1.1 IKL**

**SO AS NOT TO MISUNDERSTAND  
THE RUNWAY**

MINIMA with Missed APCH climb gradient of 2.5% are not established.  
MINIMA APPLICATION CRITERIA in AD1.6.10.1.4 are not applicable.

INSTRUMENT APPROACH CHART

RJTT / TOKYO INTL

LDA W RWY22

Visual Prescribed Track for LDA W RWY22

Visual manoeuvre with Prescribed Track (VPT) : VPT stands for visual maneuvering after the MAPt using prescribed track.  
 Note : Remain on the LDA until passing MAPt so as not to penetrate the NTZ, and to avoid the RWY23 traffic.

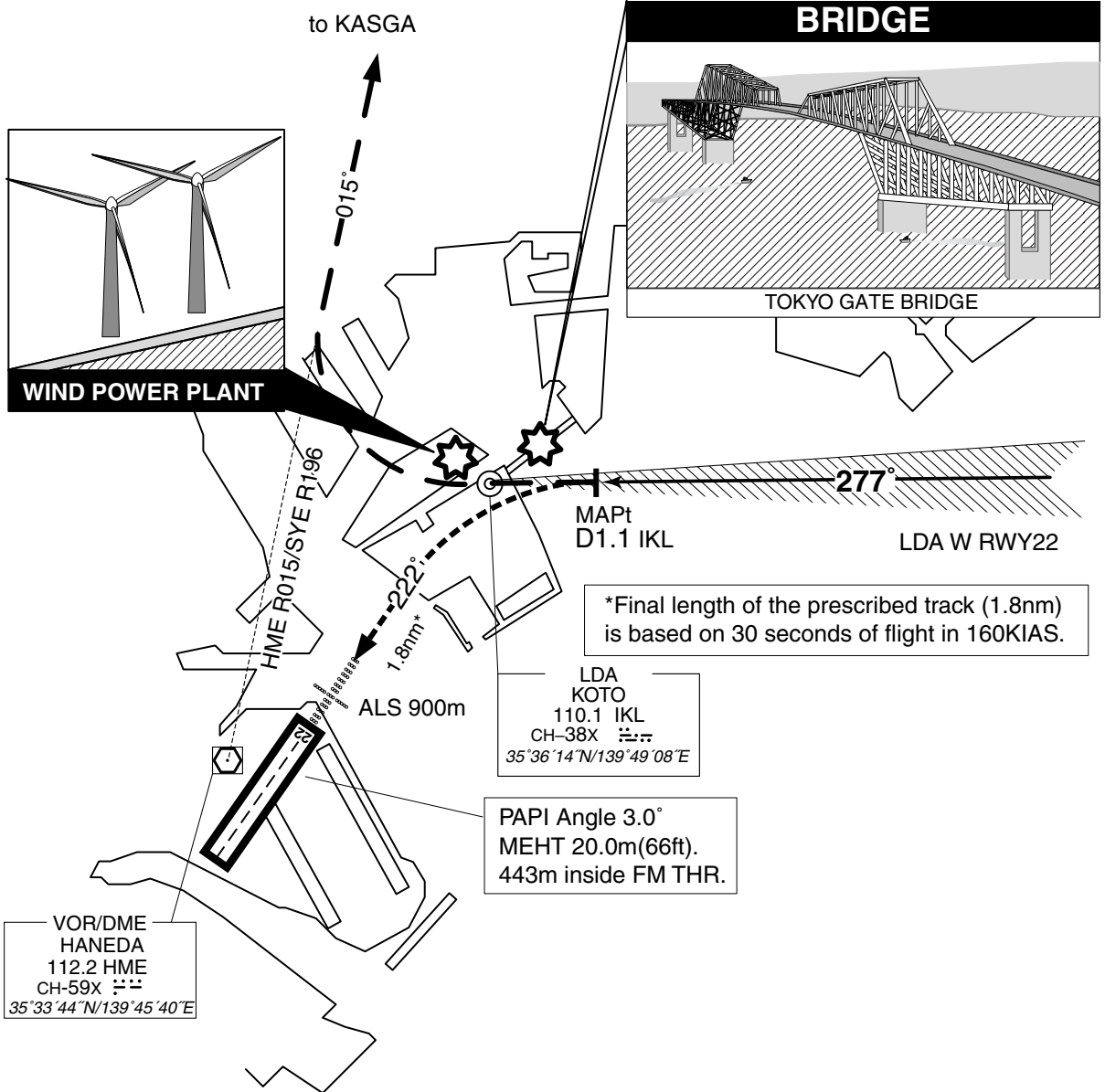

In case of GO AROUND, pilot should report ATC as soon as practicable.  
 Until receiving ATC instructions, aircraft turn right for joining HME R015/SYE R196 and missed approach procedure.

STANDARD ARRIVAL CHART-INSTRUMENT

RJTT / TOKYO INTL

RNAV STAR RWY22/23

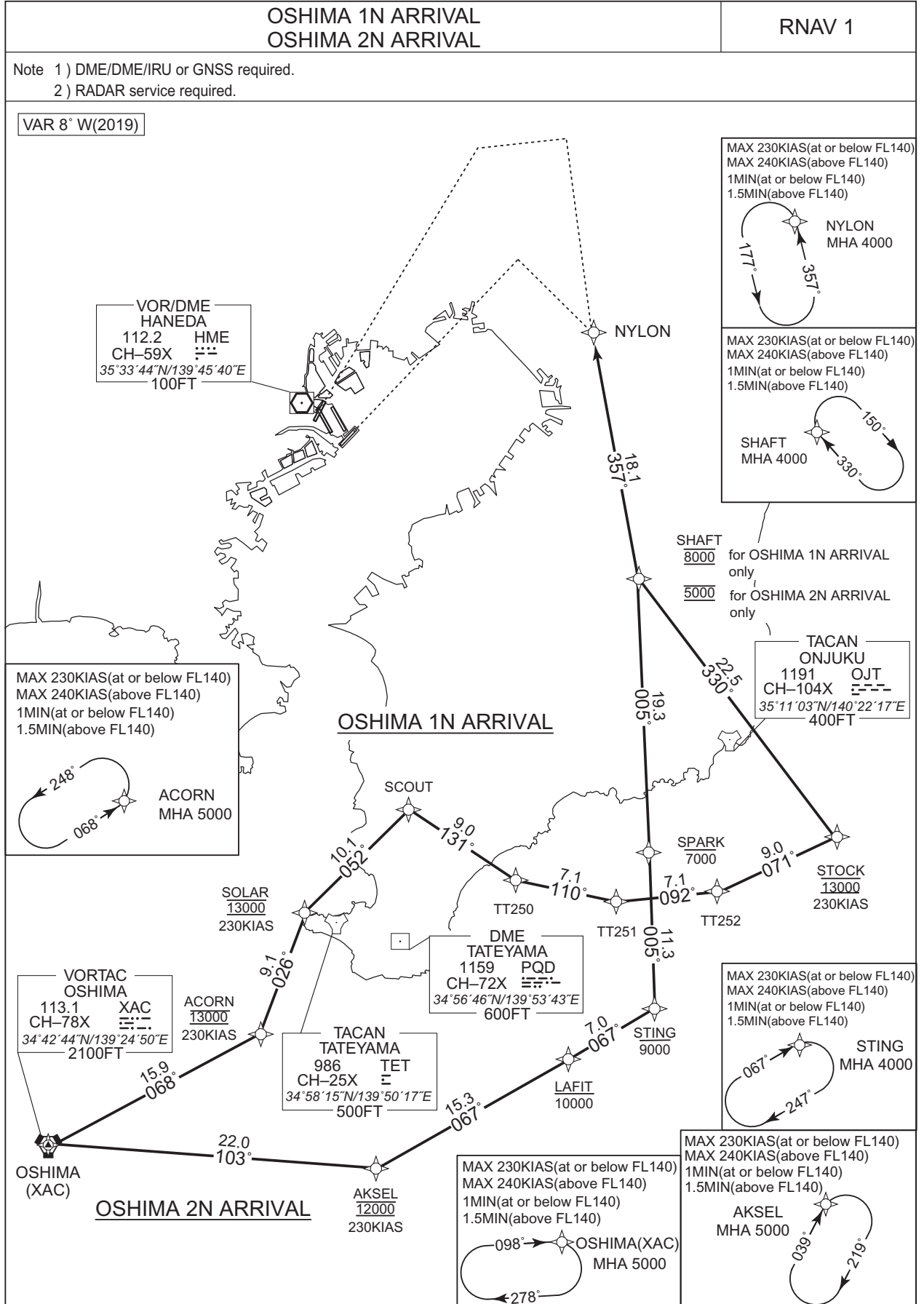

STANDARD ARRIVAL CHART-INSTRUMENT

RJTT / TOKYO INTL

RNAV STAR RWY22/23

OSHIMA 1N ARRIVAL

From XAC, to ACORN at 13000FT, to SOLAR at 13000FT, to SCOUT, to TT250, to TT251, to TT252, to STOCK at 13000FT, to SHAFT at 8000FT, to NYLON.

Critical DME	-
DME GAP	-
Inappropriate Nav aids	See AD1.1.6.10.3. Inappropriate NAVAIDs for RNAV1

Serial Number	Path Descriptor	Waypoint Identifier	Fly Over	Course °M(°T)	Magnetic Variation	Distance (NM)	Turn Direction	Altitude (FT)	Speed (KIAS)	Vertical Angle	Navigation Specification
001	IF	XAC	-	-	-7.5	-	-	-	-	-	RNAV1
002	TF	ACORN	-	068 (060.8)	-7.5	15.9	-	13000	230	-	RNAV1
003	TF	SOLAR	-	026 (018.4)	-7.5	9.1	-	13000	230	-	RNAV1
004	TF	SCOUT	-	052 (044.3)	-7.5	10.1	-	-	-	-	RNAV1
005	TF	TT250	-	131 (123.1)	-7.5	9.0	-	-	-	-	RNAV1
006	TF	TT251	-	110 (102.5)	-7.5	7.1	-	-	-	-	RNAV1
007	TF	TT252	-	092 (084.3)	-7.5	7.1	-	-	-	-	RNAV1
008	TF	STOCK	-	071 (063.6)	-7.5	9.0	-	13000	230	-	RNAV1
009	TF	SHAFT	-	330 (322.4)	-7.5	22.5	-	8000	-	-	RNAV1
010	TF	NYLON	-	357 (350.0)	-7.5	18.1	-	-	-	-	RNAV1

Path	Waypoint Identifier	Inbound Course °M(°T)	Magnetic Variation	Outbound Time (MIN)	Outbound Distance (NM)	Turn Direction	Minimum Altitude (FT)	Maximum Altitude (FT)	Speed (KIAS)	Navigation Specification
Hold	XAC	098 (090.3)	-7.5	1.0(-14000) 1.5(+14001)	-	R	5000	-	-230(-14000) -240(+14001)	RNAV1
Hold	ACORN	068 (060.8)	-7.5	1.0(-14000) 1.5(+14001)	-	L	5000	-	-230(-14000) -240(+14001)	RNAV1
Hold	SHAFT	330 (322.4)	-7.5	1.0(-14000) 1.5(+14001)	-	R	4000	-	-230(-14000) -240(+14001)	RNAV1
Hold	NYLON	357 (350.0)	-7.5	1.0(-14000) 1.5(+14001)	-	L	4000	-	-230(-14000) -240(+14001)	RNAV1

CHANGE : SOLAR renamed



STANDARD ARRIVAL CHART-INSTRUMENT

RJTT / TOKYO INTL

RNAV STAR RWY22/23

OSHIMA 2N ARRIVAL

From XAC, to AKSEL at 12000FT, to LAFIT at or below 10000FT, to STING at or below 9000FT, to SPARK at or below 7000FT, to SHAFT at 5000FT, to NYLON.

Critical DME	-
DME GAP	-
Inappropriate Navaids	See AD1.1.6.10.3. Inappropriate NAVAIDs for RNAV1

Serial Number	Path Descriptor	Waypoint Identifier	Fly Over	Course °M(°T)	Magnetic Variation	Distance (NM)	Turn Direction	Altitude (FT)	Speed (KIAS)	Vertical Angle	Navigation Specification
001	IF	XAC	-	-	-7.5	-	-	-	-	-	RNAV1
002	TF	AKSEL	-	103 (095.3)	-7.5	22.0	-	12000	230	-	RNAV1
003	TF	LAFIT	-	067 (059.5)	-7.5	15.3	-	-10000	-	-	RNAV1
004	TF	STING	-	067 (059.6)	-7.5	7.0	-	-9000	-	-	RNAV1
005	TF	SPARK	-	005 (357.4)	-7.5	11.3	-	-7000	-	-	RNAV1
006	TF	SHAFT	-	005 (357.4)	-7.5	19.3	-	5000	-	-	RNAV1
007	TF	NYLON	-	357 (350.0)	-7.5	18.1	-	-	-	-	RNAV1

Path	Waypoint Identifier	Inbound Course °M(°T)	Magnetic Variation	Outbound Time (MIN)	Outbound Distance (NM)	Turn Direction	Minimum Altitude (FT)	Maximum Altitude (FT)	Speed (KIAS)	Navigation Specification
Hold	XAC	098 (090.3)	-7.5	1.0(-14000) 1.5(+14001)	-	R	5000	-	-230(-14000) -240(+14001)	RNAV1
Hold	AKSEL	039 (031.2)	-7.5	1.0(-14000) 1.5(+14001)	-	R	5000	-	-230(-14000) -240(+14001)	RNAV1
Hold	STING	067 (059.6)	-7.5	1.0(-14000) 1.5(+14001)	-	R	4000	-	-230(-14000) -240(+14001)	RNAV1
Hold	SHAFT	330 (322.4)	-7.5	1.0(-14000) 1.5(+14001)	-	R	4000	-	-230(-14000) -240(+14001)	RNAV1
Hold	NYLON	357 (350.0)	-7.5	1.0(-14000) 1.5(+14001)	-	L	4000	-	-230(-14000) -240(+14001)	RNAV1

Waypoint Coordinates

Waypoint Identifier	Coordinates	Waypoint Identifier	Coordinates
ACORN	345028.8N / 1394146.7E	SPARK	350312.0N / 1401416.7E
AKSEL	344039.5N / 1395126.9E	STOCK	350438.7N / 1403002.9E
LAFIT	344826.0N / 1400732.4E	STING	345157.9N / 1401453.4E
NYLON	354018.5N / 1400919.9E	TT250	350129.7N / 1400308.5E
SCOUT	350624.1N / 1395356.8E	TT251	345957.7N / 1401136.0E
SHAFT	352227.4N / 1401313.3E	TT252	350039.9N / 1402013.0E
SOLAR	345909.2N / 1394518.5E	XAC	344244.1N / 1392450.5E

CHANGE : SOLAR renamed

RJTT / TOKYO INTL

Minimum Vectoring Altitude CHART

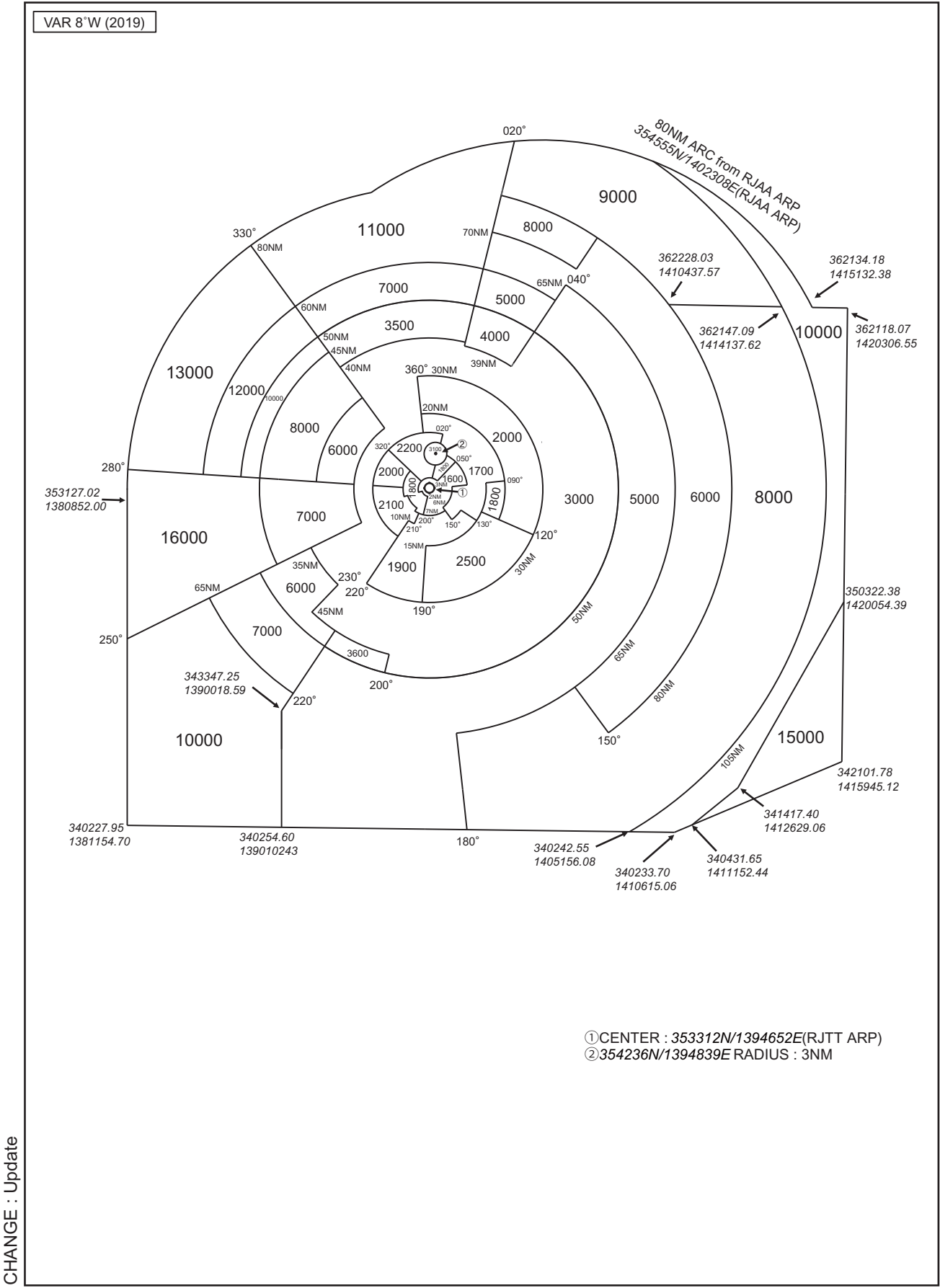

INSTRUMENT APPROACH CHART

RJTT / TOKYO INTL

LDA W RWY23

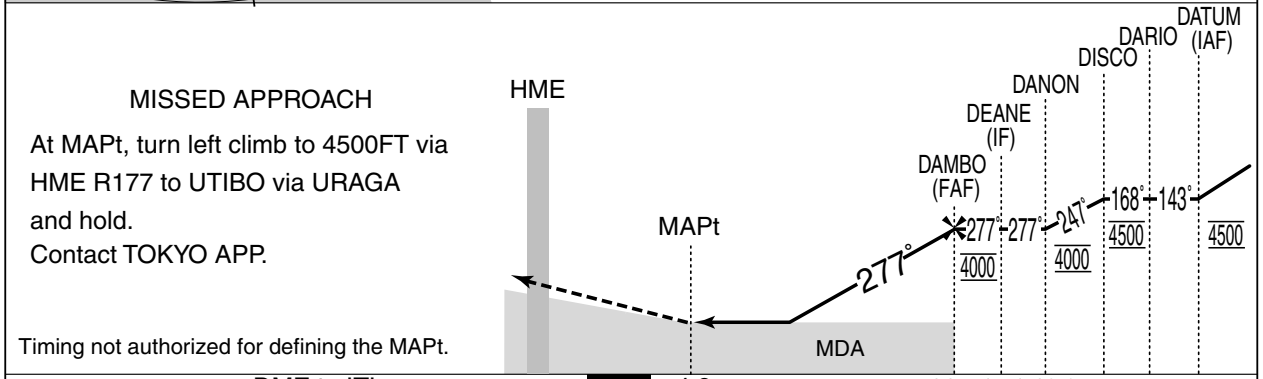
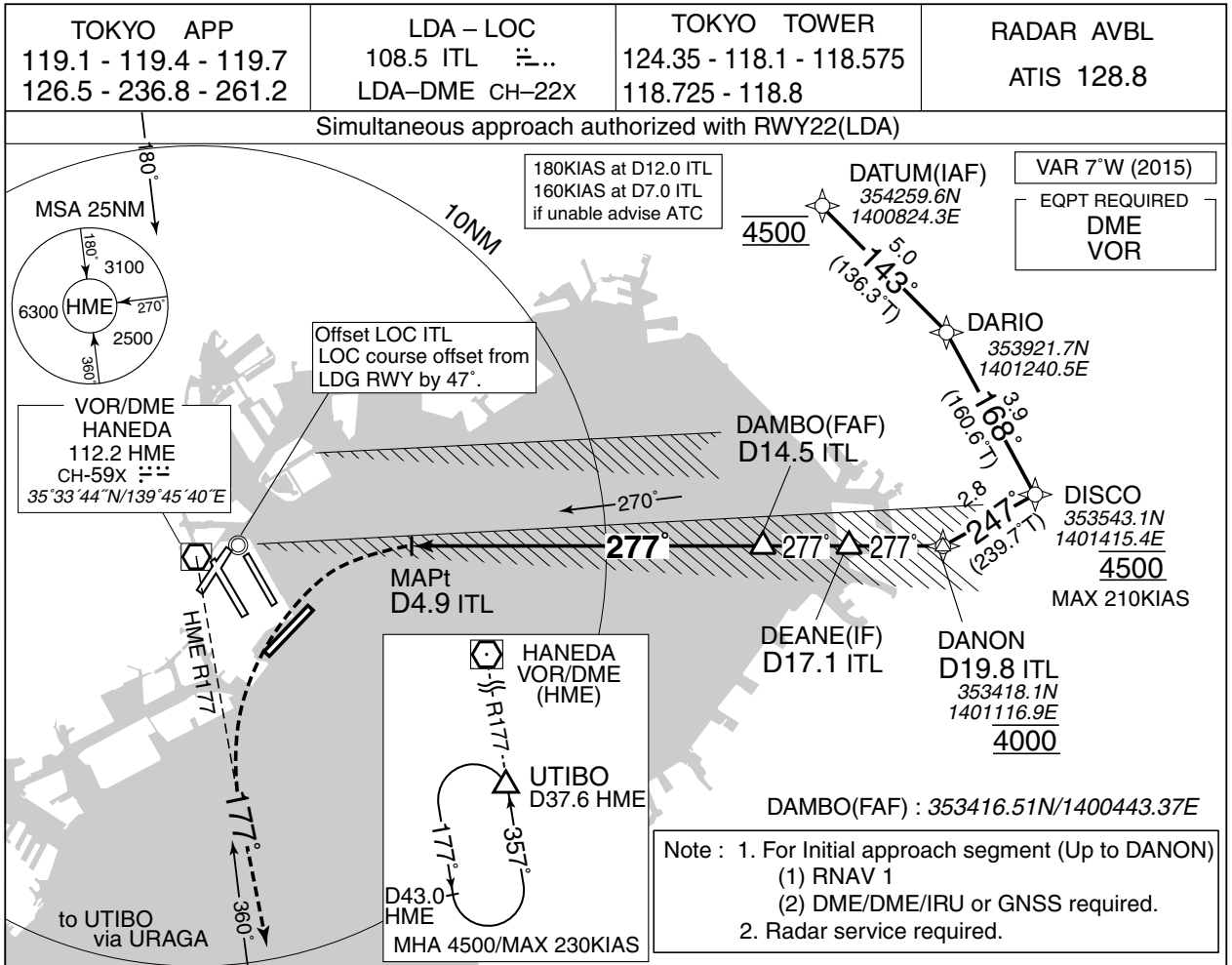

DME to ITL	4.9
NM to THR	3.4
14.5	17.1
13.0	15.6
19.8	18.3

MINIMA	THR elev. 55	AD elev. 21
CAT	MDA(H)	VIS
A	1000 (979)	6000
B		
C		
D		

MINIMA APPLICATION CRITERIA in AD1.1.6.10.1.4 are not applicable.

INSTRUMENT APPROACH CHART

RJTT / TOKYO INTL

LDA W RWY23

Visual Prescribed Track for LDA W RWY23

Visual manoeuvre with Prescribed Track (VPT) : VPT stands for visual maneuvering after the MAPt using prescribed track.

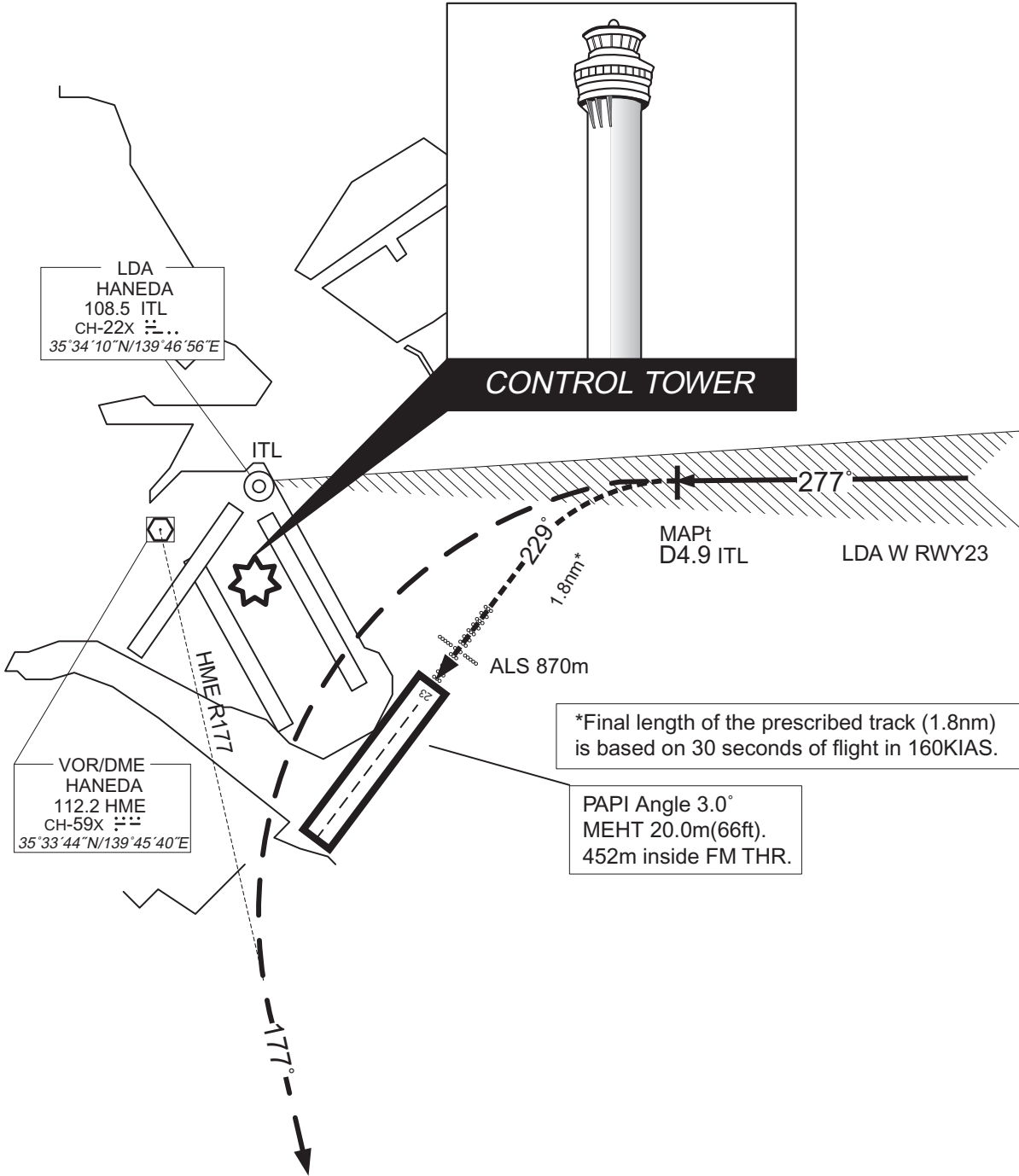

CHANGE : Correction of misdescription (ITL COORD).

In case of GO AROUND, pilot should report ATC as soon as practicable.  
Until receiving ATC instructions, aircraft turn left HDG 229° for joining HME R177 and missed approach procedure.

INSTRUMENT APPROACH CHART

RJTT / TOKYO INTL

LDA X RWY22

TOKYO APP 119.1 - 119.4 - 119.7 126.5 - 236.8 - 261.2	LDA - LOC 110.1 IKL LDA-DME CH-38X	TOKYO TOWER 118.575 - 118.1 - 124.35 118.725 - 118.8	RADAR AVBL ATIS 128.8
---	--	--	--------------------------

Simultaneous approach authorized with RWY23(LDA)

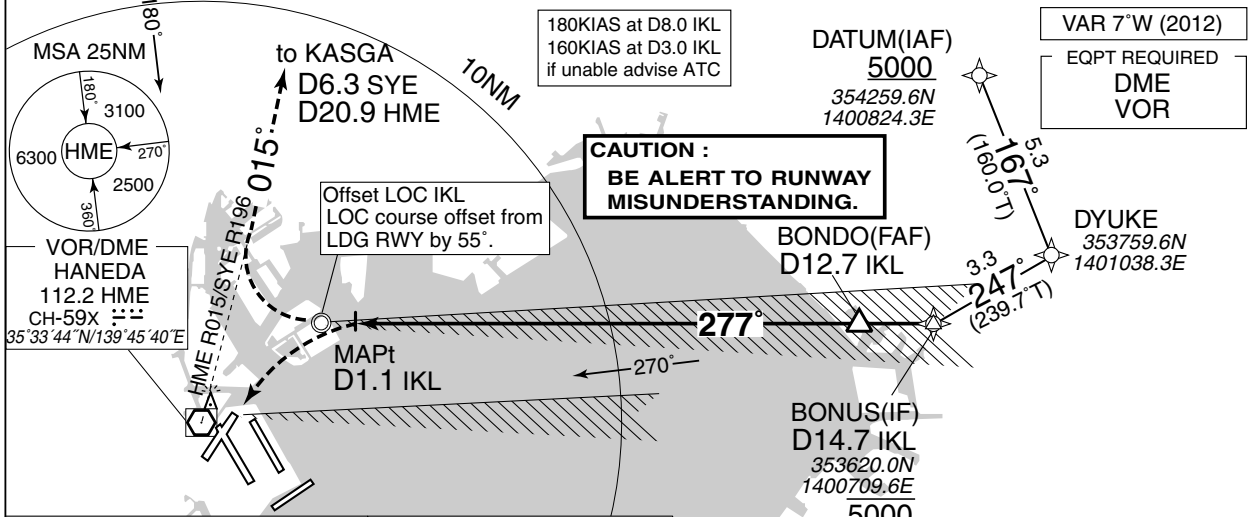

**CAUTION :**  
BE ALERT TO RUNWAY  
MISUNDERSTANDING.

VAR 7°W (2012)  
EQPT REQUIRED  
DME  
VOR

180KIAS at D8.0 IKL  
160KIAS at D3.0 IKL  
if unable advise ATC

Offset LOC IKL  
LOC course offset from  
LDG RWY by 55°.

Note : 1. For Initial approach segment  
from over DATUM  
(1) RNAV 1  
(2) DME/DME/IRU or GNSS required  
2. Radar service required.

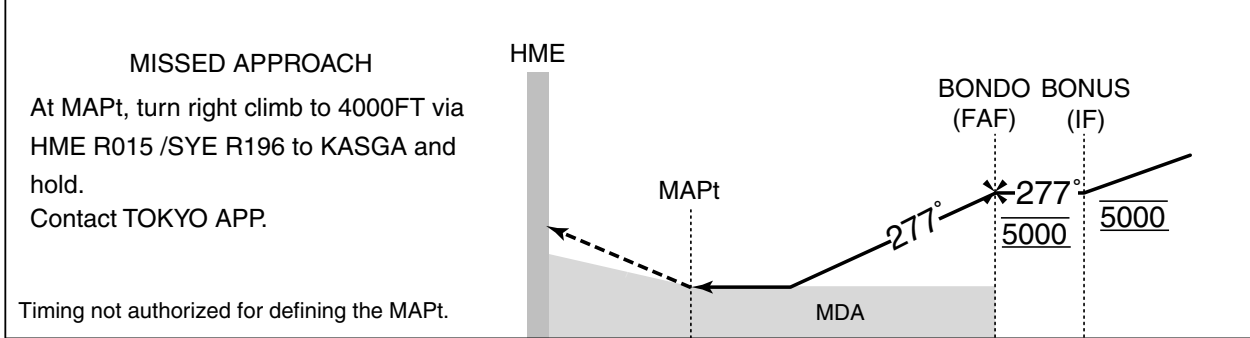
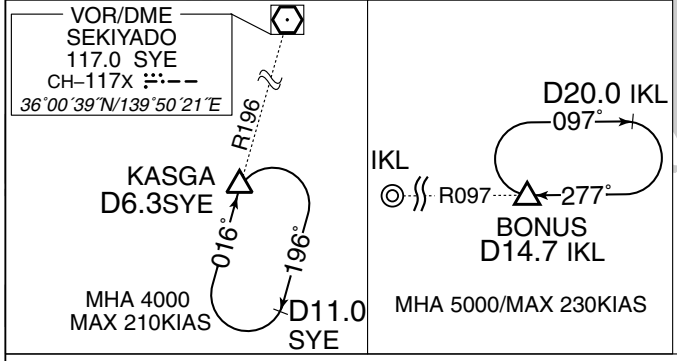

DME to IKL	1.1	12.7	14.7
NM to THR	3.8	15.4	17.4

Missed APCH climb gradient MNM 4.0%

MINIMA	THR elev. 35	AD elev. 21
CAT	MDA(H)	VIS
A	1000 (979)	6000
B		
C		
D		

**Do Not turn left  
until D1.1 IKL  
SO AS NOT TO MISUNDERSTAND  
THE RUNWAY**

MINIMA with Missed APCH climb gradient of 2.5% are not established.  
MINIMA APPLICATION CRITERIA in AD1.6.10.1.4 are not applicable.

INSTRUMENT APPROACH CHART

RJTT / TOKYO INTL

LDA X RWY22

Visual Prescribed Track for LDA X RWY22

Visual manoeuvre with Prescribed Track (VPT) : VPT stands for visual maneuvering after the MAPt using prescribed track.  
 Note : Remain on the LDA until passing MAPt so as not to penetrate the NTZ, and to avoid the RWY23 traffic.

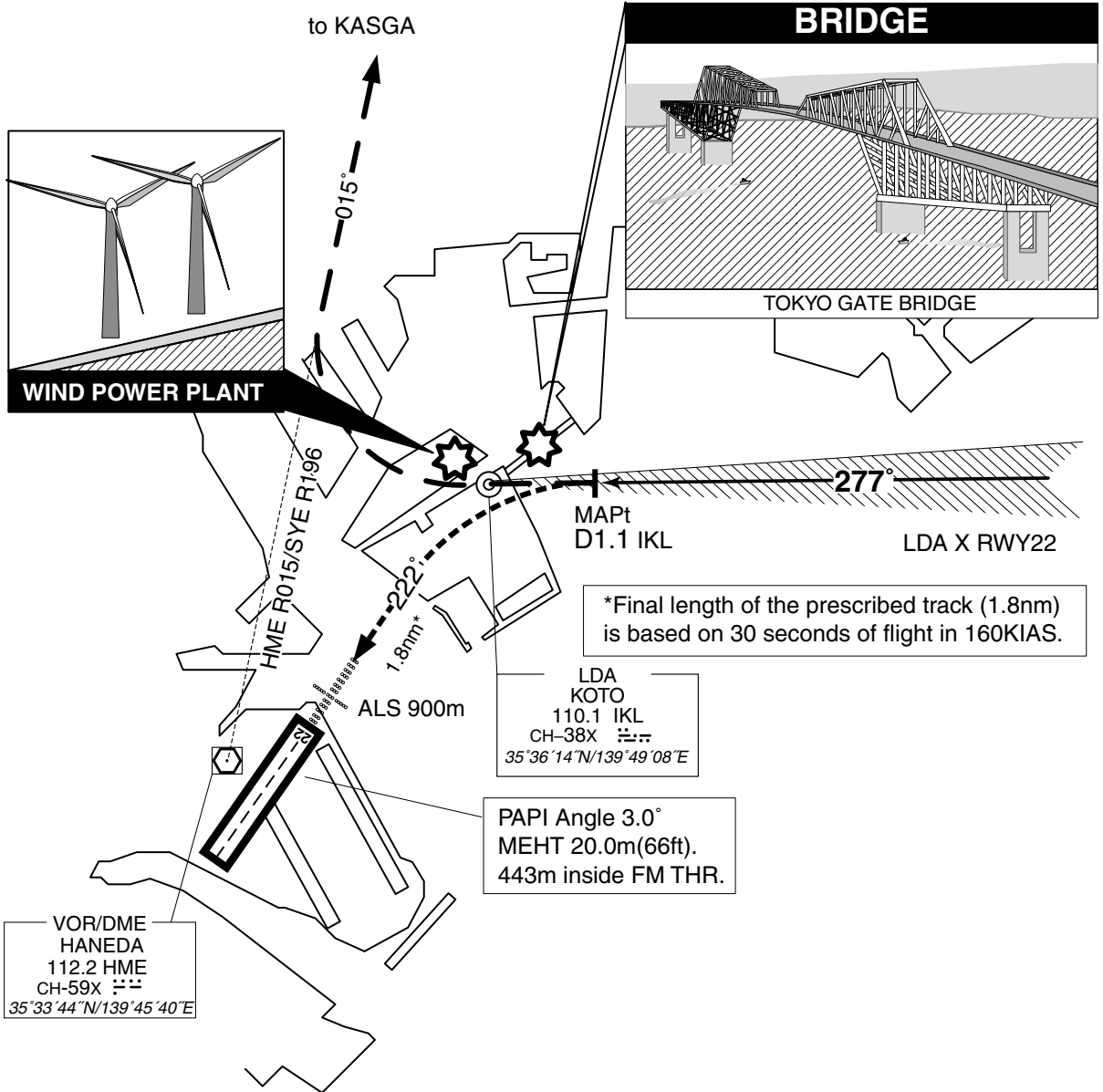

In case of GO AROUND, pilot should report ATC as soon as practicable.  
 Until receiving ATC instructions, aircraft turn right for joining HME R015/SYE R196 and missed approach procedure.

INSTRUMENT APPROACH CHART

RJTT / TOKYO INTL

LDA X RWY23

TOKYO APP 119.1 - 119.4 - 119.7 126.5 - 236.8 - 261.2	LDA - LOC 108.5 ITL 3.. LDA-DME CH-22X	TOKYO TOWER 124.35 - 118.1 - 118.575 118.725 - 118.8	RADAR AVBL ATIS 128.8
---	--	--	--------------------------

Simultaneous approach authorized with RWY22(LDA)

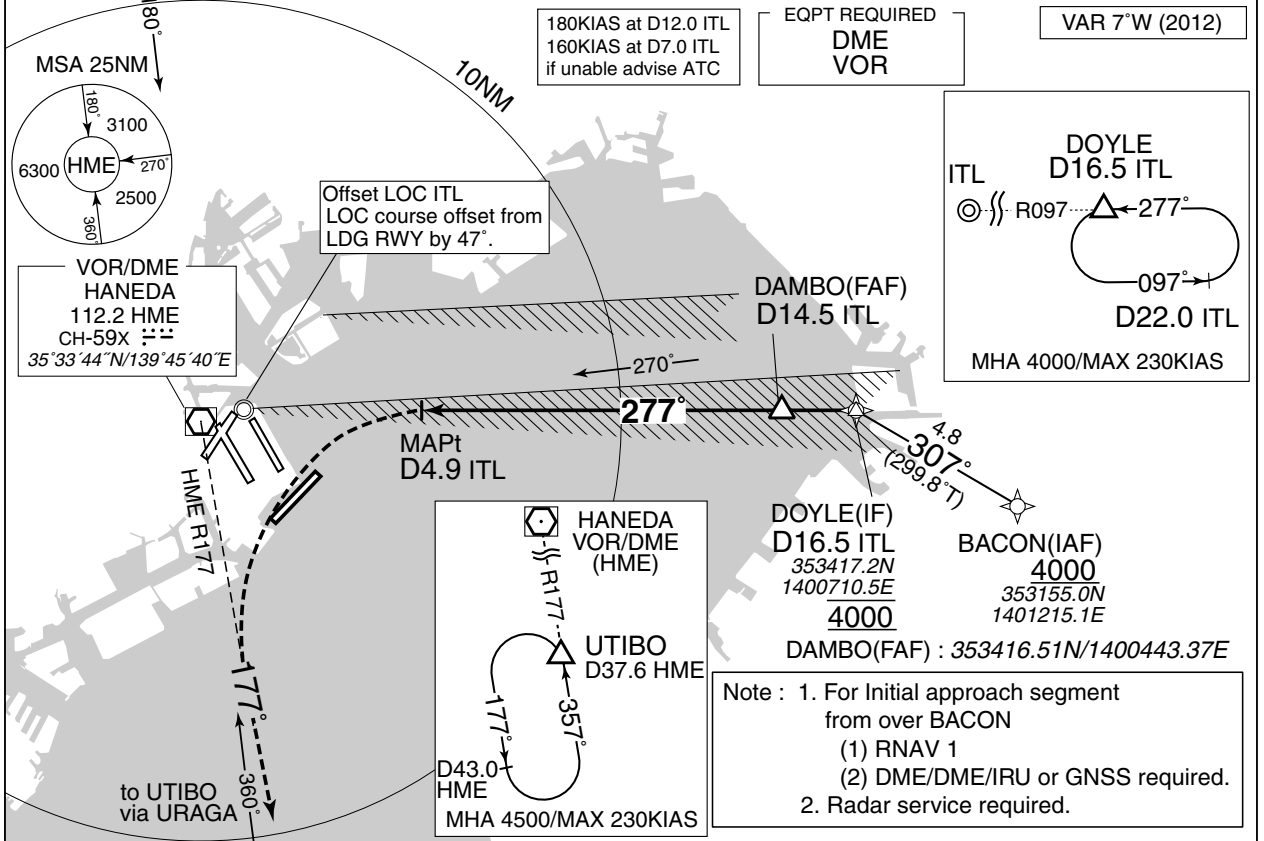

MISSED APPROACH

At MAPt, turn left climb to 4500FT via  
HME R177 to UTIBO via URAGA  
and hold.  
Contact TOKYO APP.

Timing not authorized for defining the MAPt.

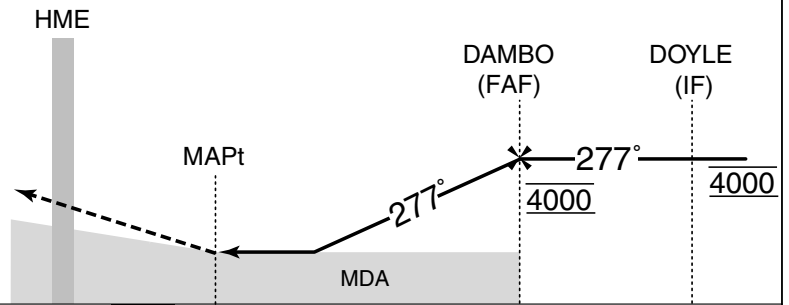

DME to ITL	4.9	14.5	16.5
NM to THR	3.4	13.0	15.0

MINIMA	THR elev. 55	AD elev. 21
CAT	MDA(H)	VIS
A	1000 (979)	6000
B		
C		
D		

MINIMA APPLICATION CRITERIA in AD1.1.6.10.1.4 are not applicable.

INSTRUMENT APPROACH CHART

RJTT / TOKYO INTL

LDA X RWY23

Visual Prescribed Track for LDA X RWY23

Visual manoeuvre with Prescribed Track (VPT) : VPT stands for visual maneuvering after the MAPt using prescribed track.

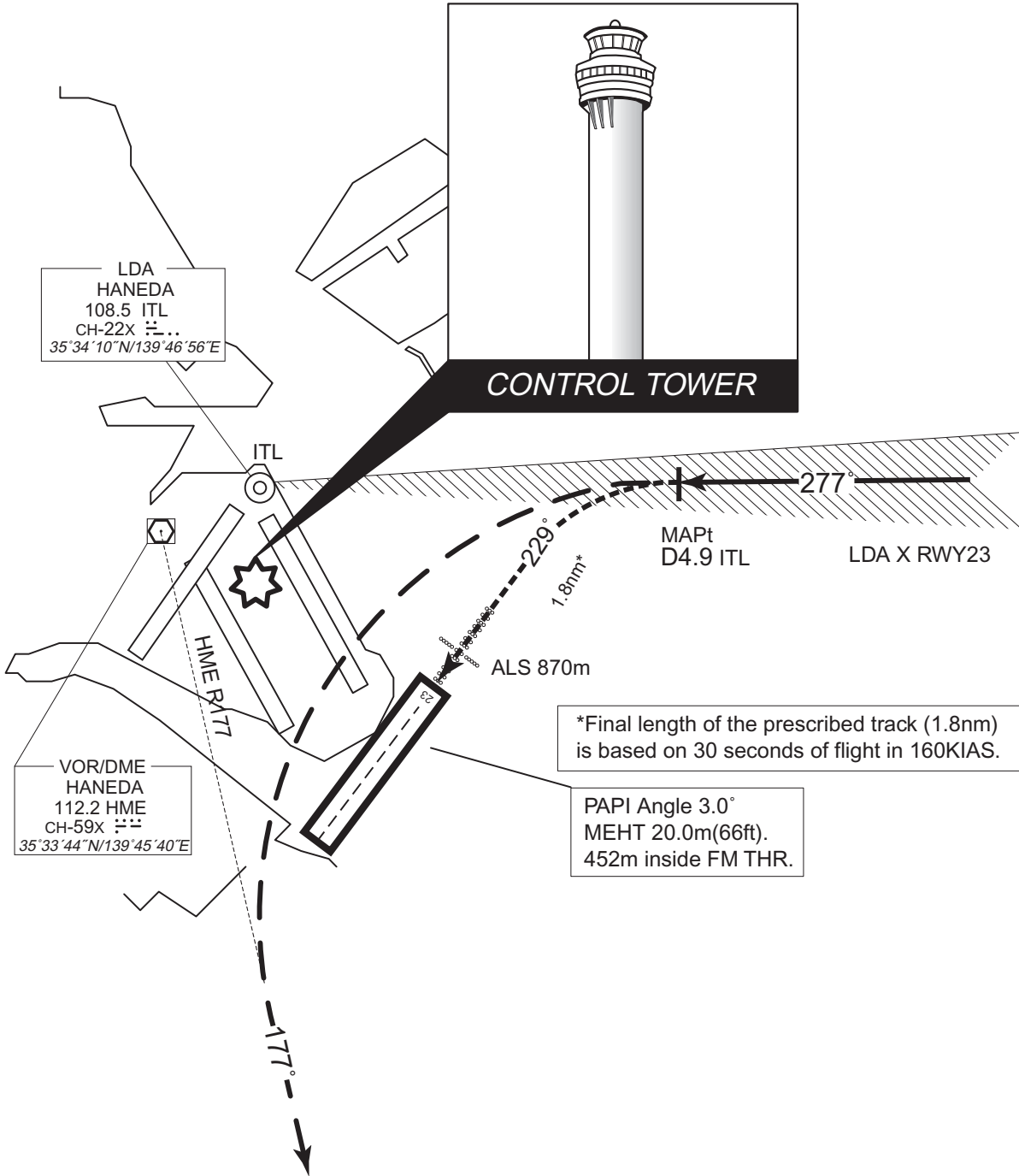

\*Final length of the prescribed track (1.8nm) is based on 30 seconds of flight in 160KIAS.

PAPI Angle 3.0°  
MEHT 20.0m(66ft).  
452m inside FM THR.

CHANGE : Correction of misdescription (ITL COORD).

In case of GO AROUND, pilot should report ATC as soon as practicable.  
Until receiving ATC instructions, aircraft turn left HDG 229° for joining HME R177 and missed approach procedure.



INSTRUMENT APPROACH CHART

RJTT / TOKYO INTL

ILS X RWY34L

TOKYO APP 119.1 - 119.4 - 119.7 126.5 - 236.8 - 261.2	ILS - LOC 111.7 IHA ILS-GP 333.5 ILS-DME CH-54X	TOKYO TOWER 118.1 - 124.35 - 118.575 118.725 - 118.8	RADAR AVBL ATIS 128.8
---	--	--	--------------------------

Simultaneous approach authorized with RWY34R

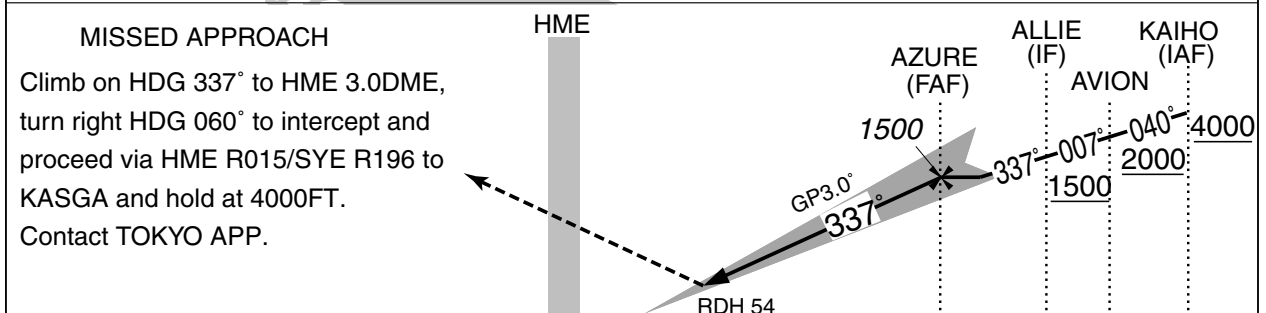
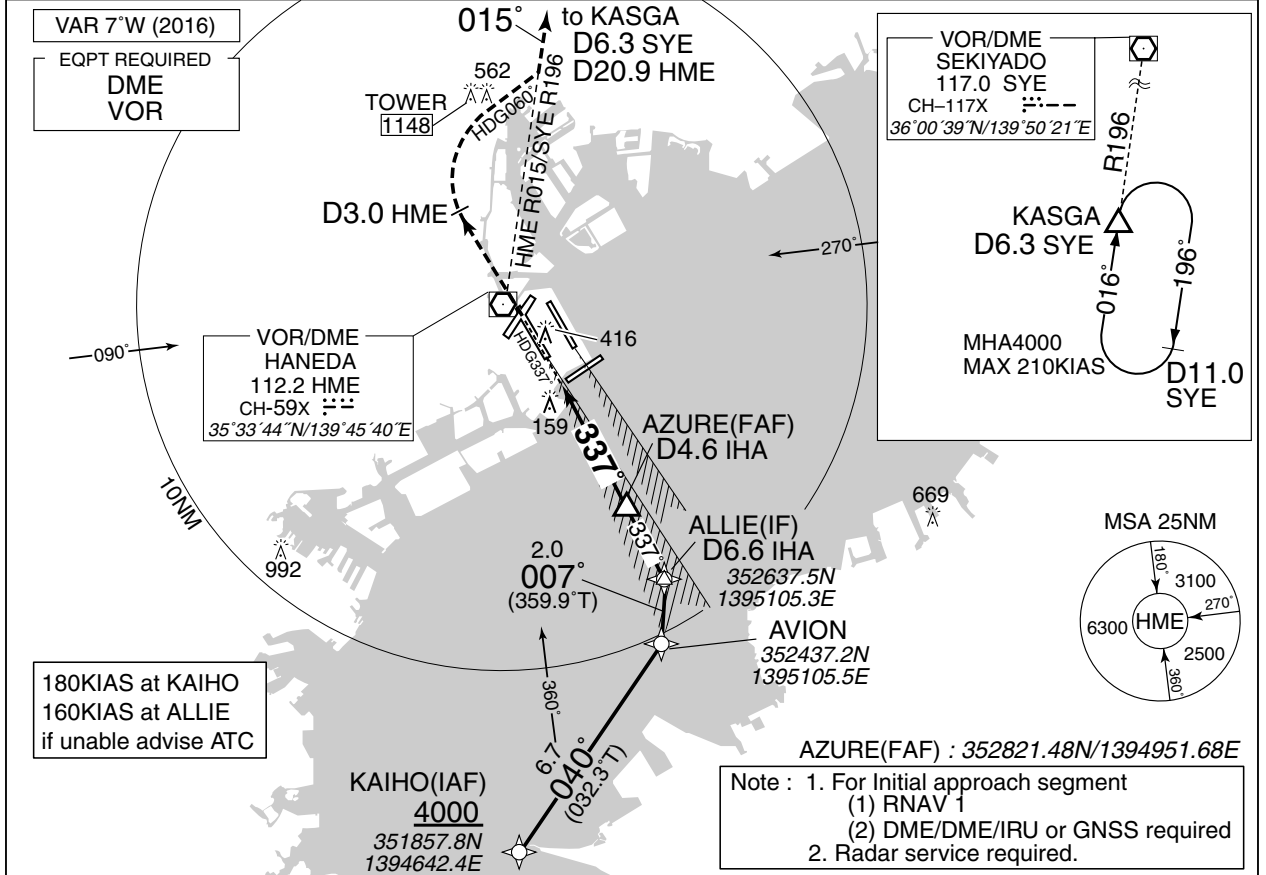

DME to IHA	0.2	4.6	6.6
NM to THR	0	4.4	6.4

Missed APCH climb gradient MNM 5.0%

MINIMA	THR elev. 18	AD elev. 21			
CAT	CAT I		CIRCLING		
	DA(H)	RVR/CMV	MDA(H)	VIS	
A	218 (200)	550	730 (709)	1600	
B				2400	
C					3200
D					

MINIMA with Missed APCH climb gradient of 2.5% are not established.  
Circling is not authorized during the night time, except counterclockwise circling to RWY16R/16L/34R.

INSTRUMENT APPROACH CHART

RJTT / TOKYO INTL

LOC X RWY34L

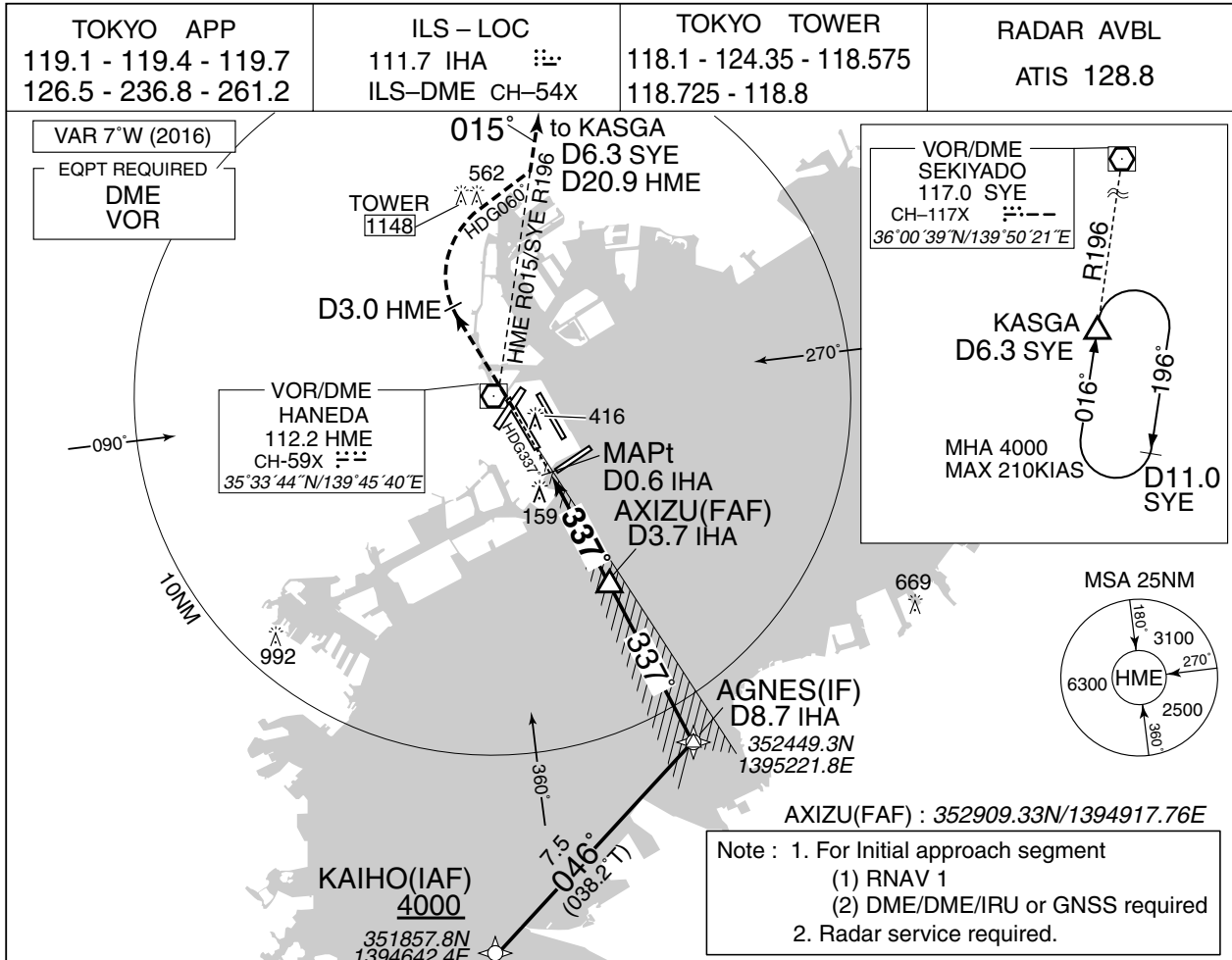

NM to IHA	MAPt	2	3	FAF
ALT (3.0° APCH Path)	-	646	964	1184

**MISSED APPROACH**  
Climb on HDG 337° to HME 3.0DME, turn right HDG 060° to intercept and proceed via HME R015/SYE R196 to KASGA and hold at 4000FT. Contact TOKYO APP.  
Timing not authorized for defining the MAPt.

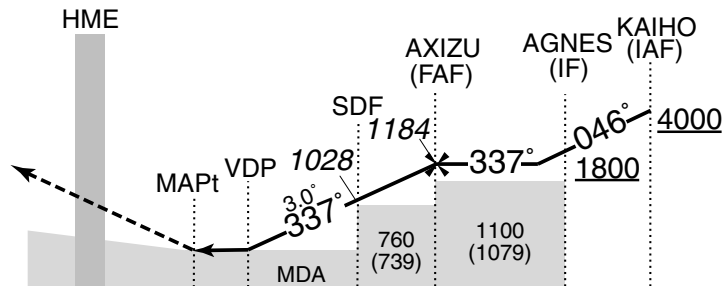

DME to IHA	0.2	0.6	1.8	3.2	3.7	8.7
NM to THR	0	0.5	1.6	3.0	3.5	8.5

Missed APCH climb gradient MNM 3.0%

MINIMA		THR elev. 18		AD elev. 21		
CAT	LOC		CIRCLING		VIS	
	MDA(H)	RVR/CMV	MDA(H)			
A	560 (539)	1000	730 (709)		1600	
B		1200				
C		1600				2400
D						3200

MINIMA with Missed APCH climb gradient of 2.5% are not established.  
Circling is not authorized during the night time, except counterclockwise circling to RWY16R/16L/34R.

AERODROME OBSTACLE CHART-ICAO  
TYPE A (OPERATING LIMITATIONS)

DIMENSIONS AND ELEVATIONS IN FEET BEARINGS ARE MAGNETIC

MAGNETIC VARIATION 7°W-APR 2015

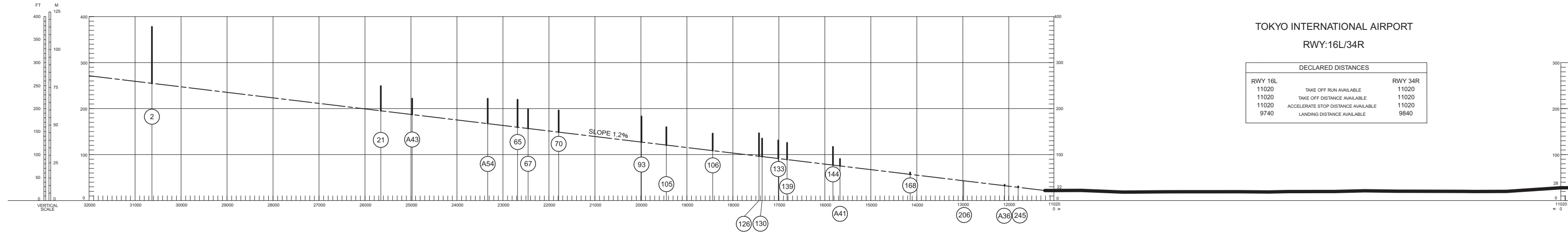

TOKYO INTERNATIONAL AIRPORT  
RWY:16L/34R

DECLARED DISTANCES		
RWY 16L		RWY 34R
11020	TAKE OFF RUN AVAILABLE	11020
11020	TAKE OFF DISTANCE AVAILABLE	11020
11020	ACCELERATE STOP DISTANCE AVAILABLE	11020
9740	LANDING DISTANCE AVAILABLE	9840

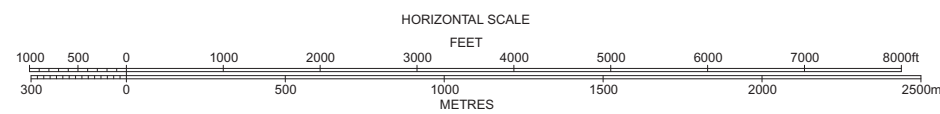
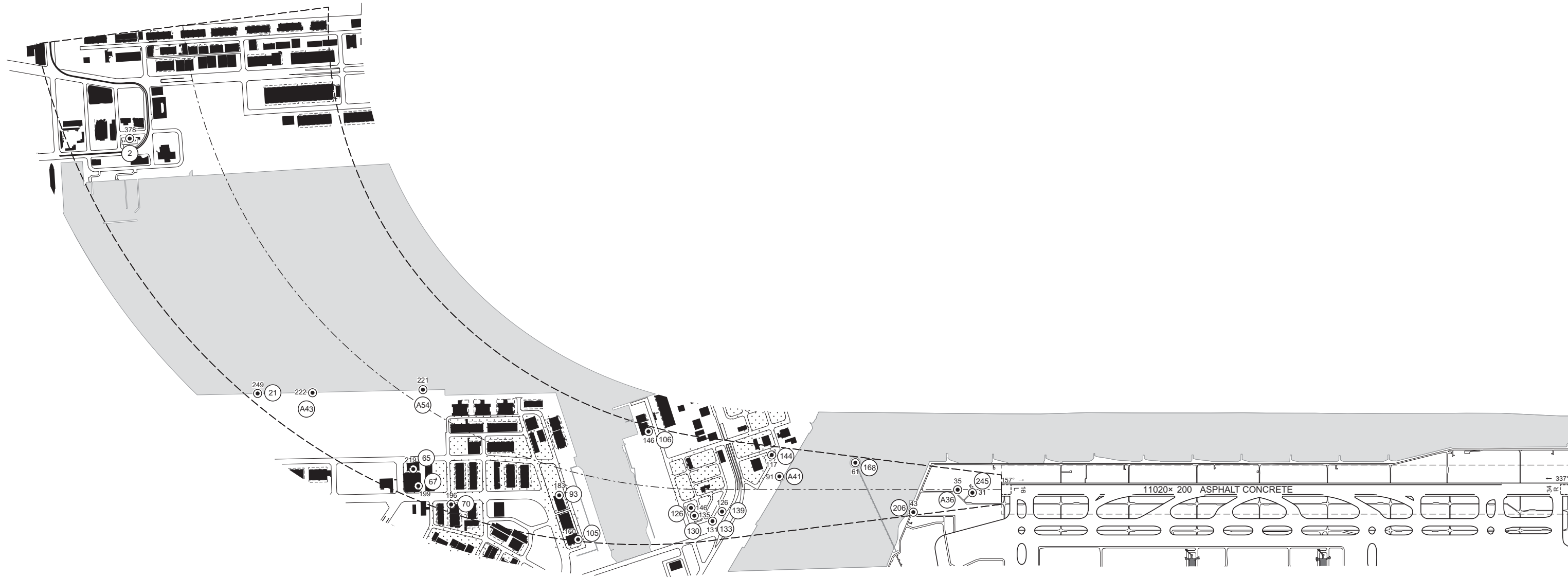

CHANGE: DECLARED DISTANCES

LEGEND		AMENDMENT RECORD		
Symbol	Description	Nr	DATE	ENTERED BY
①	IDENTIFICATION NUMBER			
⊙	POLE, TOWER, SPIRE, ANTENNA, ETC			
✳	TREE			
—+—+—	RAILROAD			
—+—+—	RIVER			
—+—+—	TRANSMISSION LINE OR OVERHEAD CABLE			
△	TRIANGULATION POINT			
★	AERONAUTICAL GROUND LIGHT			

STANDARD ARRIVAL CHART-INSTRUMENT

RJTT / TOKYO INTL

RNAV STAR RWY34R/34L

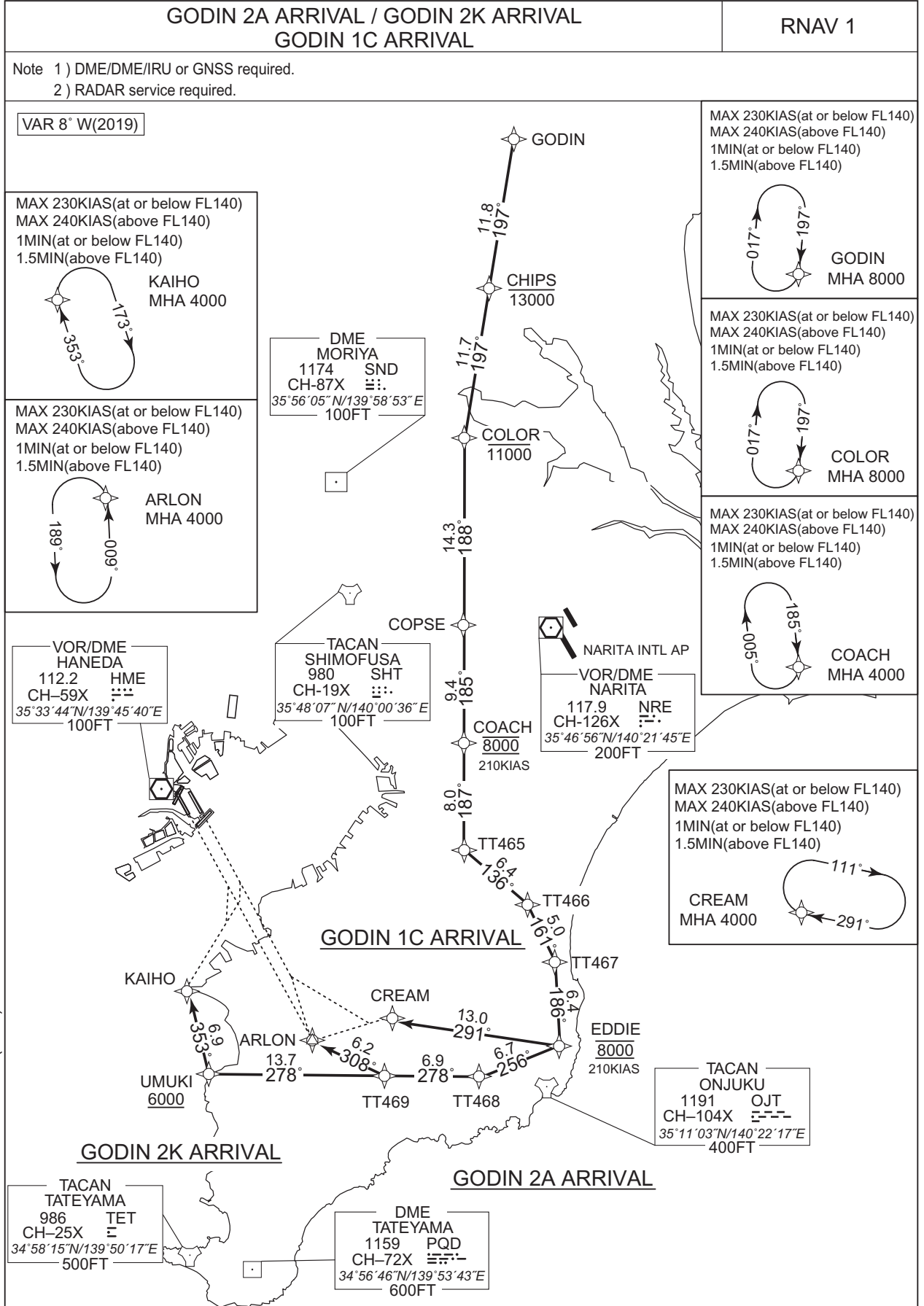

CHANGE : HOKUSO VOR/DME(HKE) abolished.

## STANDARD ARRIVAL CHART-INSTRUMENT

RJTT / TOKYO INTL

RNAV STAR RWY34R/34L

GODIN 2A ARRIVAL

From GODIN, to CHIPS at or below 13000FT, to COLOR at or below 11000FT, to COPSE, to COACH at 8000FT, to TT465, to TT466, to TT467, to EDDIE at 8000FT, to TT468, to TT469, to ARLON.

Critical DME	-
DME GAP	-
Inappropriate Navaids	See AD1.1.6.10.3. Inappropriate NAVAIDs for RNAV1

Serial Number	Path Descriptor	Waypoint Identifier	Fly Over	Course °M(°T)	Magnetic Variation	Distance (NM)	Turn Direction	Altitude (FT)	Speed (KIAS)	Vertical Angle	Navigation Specification
001	IF	GODIN	-	-	-7.5	-	-	-	-	-	RNAV1
002	TF	CHIPS	-	197 (189.1)	-7.5	11.8	-	-13000	-	-	RNAV1
003	TF	COLOR	-	197 (189.1)	-7.5	11.7	-	-11000	-	-	RNAV1
004	TF	COPSE	-	188 (180.8)	-7.5	14.3	-	-	-	-	RNAV1
005	TF	COACH	-	185 (177.8)	-7.5	9.4	-	8000	210	-	RNAV1
006	TF	TT465	-	187 (179.6)	-7.5	8.0	-	-	-	-	RNAV1
007	TF	TT466	-	136 (128.9)	-7.5	6.4	-	-	-	-	RNAV1
008	TF	TT467	-	161 (153.5)	-7.5	5.0	-	-	-	-	RNAV1
009	TF	EDDIE	-	186 (178.0)	-7.5	6.4	-	8000	210	-	RNAV1
010	TF	TT468	-	256 (248.1)	-7.5	6.7	-	-	-	-	RNAV1
011	TF	TT469	-	278 (270.2)	-7.5	6.9	-	-	-	-	RNAV1
012	TF	ARLON	-	308 (300.2)	-7.5	6.2	-	-	-	-	RNAV1

Path	Waypoint Identifier	Inbound Course °M(°T)	Magnetic Variation	Outbound Time (MIN)	Outbound Distance (NM)	Turn Direction	Minimum Altitude (FT)	Maximum Altitude (FT)	Speed (KIAS)	Navigation Specification
Hold	GODIN	197 (189.2)	-7.5	1.0(-14000) 1.5(+14001)	-	R	8000	-	-230(-14000) -240(+14001)	RNAV1
Hold	COLOR	197 (189.1)	-7.5	1.0(-14000) 1.5(+14001)	-	R	8000	-	-230(-14000) -240(+14001)	RNAV1
Hold	COACH	185 (177.8)	-7.5	1.0(-14000) 1.5(+14001)	-	R	4000	-	-230(-14000) -240(+14001)	RNAV1
Hold	ARLON	009 (001.6)	-7.5	1.0(-14000) 1.5(+14001)	-	L	4000	-	-230(-14000) -240(+14001)	RNAV1

CHANGE : New PROC

STANDARD ARRIVAL CHART-INSTRUMENT

RJTT / TOKYO INTL

RNAV STAR RWY34R/34L

GODIN 2K ARRIVAL

From GODIN ,to CHIPS at or below 13000FT, to COLOR at or below 11000FT, to COPSE, to COACH at 8000FT, to TT465, to TT466, to TT467, to EDDIE at 8000FT, to TT468, to TT469, to UMUKI at or above 6000FT, to KAIHO.

Critical DME	-
DME GAP	-
Inappropriate NavAids	See AD1.1.6.10.3. Inappropriate NAVAIDs for RNAV1

Serial Number	Path Descriptor	Waypoint Identifier	Fly Over	Course °M(°T)	Magnetic Variation	Distance (NM)	Turn Direction	Altitude (FT)	Speed (KIAS)	Vertical Angle	Navigation Specification
001	IF	GODIN	-	-	-7.5	-	-	-	-	-	RNAV1
002	TF	CHIPS	-	197 (189.1)	-7.5	11.8	-	-13000	-	-	RNAV1
003	TF	COLOR	-	197 (189.1)	-7.5	11.7	-	-11000	-	-	RNAV1
004	TF	COPSE	-	188 (180.8)	-7.5	14.3	-	-	-	-	RNAV1
005	TF	COACH	-	185 (177.8)	-7.5	9.4	-	8000	210	-	RNAV1
006	TF	TT465	-	187 (179.6)	-7.5	8.0	-	-	-	-	RNAV1
007	TF	TT466	-	136 (128.9)	-7.5	6.4	-	-	-	-	RNAV1
008	TF	TT467	-	161 (153.5)	-7.5	5.0	-	-	-	-	RNAV1
009	TF	EDDIE	-	186 (178.0)	-7.5	6.4	-	8000	210	-	RNAV1
010	TF	TT468	-	256 (248.1)	-7.5	6.7	-	-	-	-	RNAV1
011	TF	TT469	-	278 (270.2)	-7.5	6.9	-	-	-	-	RNAV1
012	TF	UMUKI	-	278 (270.2)	-7.5	13.7	-	+6000	-	-	RNAV1
013	TF	KAIHO	-	353 (345.5)	-7.5	6.9	-	-	-	-	RNAV1

Path	Waypoint Identifier	Inbound Course °M(°T)	Magnetic Variation	Outbound Time (MIN)	Outbound Distance (NM)	Turn Direction	Minimum Altitude (FT)	Maximum Altitude (FT)	Speed (KIAS)	Navigation Specification
Hold	GODIN	197 (189.2)	-7.5	1.0(-14000) 1.5(+14001)	-	R	8000	-	-230(-14000) -240(+14001)	RNAV1
Hold	COLOR	197 (189.1)	-7.5	1.0(-14000) 1.5(+14001)	-	R	8000	-	-230(-14000) -240(+14001)	RNAV1
Hold	COACH	185 (177.8)	-7.5	1.0(-14000) 1.5(+14001)	-	R	4000	-	-230(-14000) -240(+14001)	RNAV1
Hold	KAIHO	353 (345.5)	-7.5	1.0(-14000) 1.5(+14001)	-	R	4000	-	-230(-14000) -240(+14001)	RNAV1

CHANGE : New PROC

## STANDARD ARRIVAL CHART-INSTRUMENT

RJTT / TOKYO INTL

RNAV STAR RWY34R/34L

GODIN 1C ARRIVAL

From GODIN ,to CHIPS at or below 13000FT, to COLOR at or below 11000FT, to COPSE, to COACH at 8000FT, to TT465, to TT466, to TT467, to EDDIE at 8000FT, to CREAM.

Critical DME	-
DME GAP	-
Inappropriate Nav aids	See AD1.1.6.10.3. Inappropriate NAVAIDs for RNAV1

Serial Number	Path Descriptor	Waypoint Identifier	Fly Over	Course °M(°T)	Magnetic Variation	Distance (NM)	Turn Direction	Altitude (FT)	Speed (KIAS)	Vertical Angle	Navigation Specification
001	IF	GODIN	-	-	-7.5	-	-	-	-	-	RNAV1
002	TF	CHIPS	-	197 (189.1)	-7.5	11.8	-	-13000	-	-	RNAV1
003	TF	COLOR	-	197 (189.1)	-7.5	11.7	-	-11000	-	-	RNAV1
004	TF	COPSE	-	188 (180.8)	-7.5	14.3	-	-	-	-	RNAV1
005	TF	COACH	-	185 (177.8)	-7.5	9.4	-	8000	210	-	RNAV1
006	TF	TT465	-	187 (179.6)	-7.5	8.0	-	-	-	-	RNAV1
007	TF	TT466	-	136 (128.9)	-7.5	6.4	-	-	-	-	RNAV1
008	TF	TT467	-	161 (153.5)	-7.5	5.0	-	-	-	-	RNAV1
009	TF	EDDIE	-	186 (178.0)	-7.5	6.4	-	8000	210	-	RNAV1
010	TF	CREAM	-	291 (283.1)	-7.5	13.0	-	-	-	-	RNAV1

Path	Waypoint Identifier	Inbound Course °M(°T)	Magnetic Variation	Outbound Time (MIN)	Outbound Distance (NM)	Turn Direction	Minimum Altitude (FT)	Maximum Altitude (FT)	Speed (KIAS)	Navigation Specification
Hold	GODIN	197 (189.2)	-7.5	1.0(-14000) 1.5(+14001)	-	R	8000	-	-230(-14000) -240(+14001)	RNAV1
Hold	COLOR	197 (189.1)	-7.5	1.0(-14000) 1.5(+14001)	-	R	8000	-	-230(-14000) -240(+14001)	RNAV1
Hold	COACH	185 (177.8)	-7.5	1.0(-14000) 1.5(+14001)	-	R	4000	-	-230(-14000) -240(+14001)	RNAV1
Hold	CREAM	291 (283.1)	-7.5	1.0(-14000) 1.5(+14001)	-	R	4000	-	-230(-14000) -240(+14001)	RNAV1

Waypoint Coordinates

Waypoint Identifier	Coordinates	Waypoint Identifier	Coordinates
ARLON	351525.3N / 1395859.8E	KAIHO	351857.8N / 1394642.4E
CHIPS	361247.7N / 1401436.9E	TT465	352939.2N / 1401235.4E
COACH	353736.0N / 1401231.5E	TT466	352539.0N / 1401840.1E
COLOR	360116.3N / 1401219.8E	TT467	352110.2N / 1402124.4E
COPSE	354658.8N / 1401205.4E	TT468	351216.4N / 1401402.6E
CREAM	351743.4N / 1400612.4E	TT469	351217.9N / 1400534.7E
EDDIE	351447.4N / 1402140.9E	UMUKI	351219.1N / 1394849.2E
GODIN	362425.3N / 1401655.9E		

CHANGE : New PROC



STANDARD ARRIVAL CHART-INSTRUMENT

RJTT / TOKYO INTL

RNAV STAR RWY22/23

AKSEL 1B ARRIVAL  
AKSEL 2B ARRIVAL

RNAV 1

Note 1) DME/DME/IRU or GNSS required.  
2) RADAR service required.

VAR 8° W(2019)

VOR/DME  
HANEDA  
112.2 HME  
CH-59X  
35°33'44"N/139°45'40"E  
100FT

MAX 230KIAS(at or below FL140)  
MAX 240KIAS(above FL140)  
1MIN(at or below FL140)  
1.5MIN(above FL140)

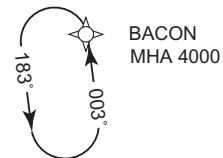

MAX 230KIAS(at or below FL140)  
MAX 240KIAS(above FL140)  
1MIN(at or below FL140)  
1.5MIN(above FL140)

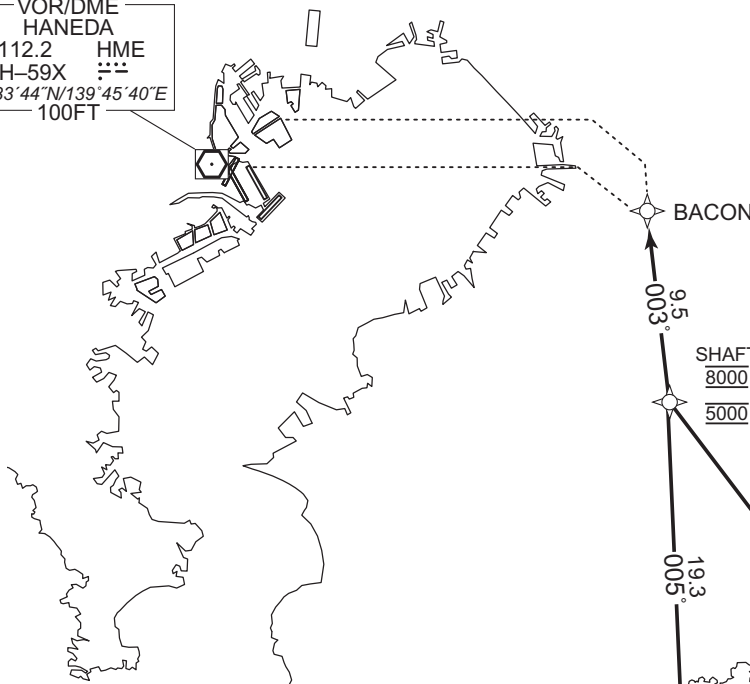
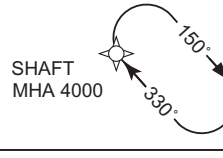

SHAFT  
8000 for AKSEL 1B ARRIVAL only  
5000 for AKSEL 2B ARRIVAL only

TACAN  
ONJUKU  
1191 OJT  
CH-104X  
35°11'03"N/140°22'17"E  
400FT

AKSEL 1B ARRIVAL

TACAN  
TATEYAMA  
986 TET  
CH-25X  
34°58'15"N/139°50'17"E  
500FT

DME  
TATEYAMA  
1159 PQD  
CH-72X  
34°56'46"N/139°53'43"E  
600FT

SALLY  
12000  
230KIAS

SPARK  
7000

STOWE  
12000  
230KIAS

AKSEL 2B ARRIVAL

MAX 230KIAS(at or below FL140)  
MAX 240KIAS(above FL140)  
1MIN(at or below FL140)  
1.5MIN(above FL140)

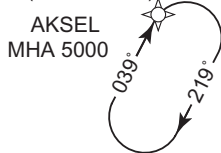

MAX 230KIAS(at or below FL140)  
MAX 240KIAS(above FL140)  
1MIN(at or below FL140)  
1.5MIN(above FL140)

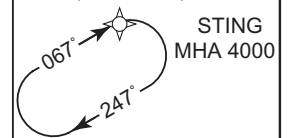

CHANGE : STOWE renamed



STANDARD ARRIVAL CHART-INSTRUMENT

RJTT / TOKYO INTL

RNAV STAR RWY22/23

AKSEL 1B ARRIVAL

From AKSEL at 12000FT, to SALLY at 12000FT, to TT253, to TT254, to TT255, to STOWE at 12000FT, to SHAFT at 8000FT, to BACON.

Critical DME	-
DME GAP	-
Inappropriate Nav aids	See AD1.1.6.10.3. Inappropriate NAVAIDs for RNAV1

Serial Number	Path Descriptor	Waypoint Identifier	Fly Over	Course °M(°T)	Magnetic Variation	Distance (NM)	Turn Direction	Altitude (FT)	Speed (KIAS)	Vertical Angle	Navigation Specification
001	IF	AKSEL	-	-	-7.5	-	-	12000	230	-	RNAV1
002	TF	SALLY	-	023 (015.0)	-7.5	13.4	-	12000	230	-	RNAV1
003	TF	TT253	-	048 (040.5)	-7.5	8.5	-	-	-	-	RNAV1
004	TF	TT254	-	109 (102.0)	-7.5	7.6	-	-	-	-	RNAV1
005	TF	TT255	-	092 (084.4)	-7.5	7.6	-	-	-	-	RNAV1
006	TF	STOWE	-	071 (063.6)	-7.5	9.6	-	12000	230	-	RNAV1
007	TF	SHAFT	-	330 (322.4)	-7.5	24.0	-	8000	-	-	RNAV1
008	TF	BACON	-	003 (355.2)	-7.5	9.5	-	-	-	-	RNAV1

Path	Waypoint Identifier	Inbound Course °M(°T)	Magnetic Variation	Outbound Time (MIN)	Outbound Distance (NM)	Turn Direction	Minimum Altitude (FT)	Maximum Altitude (FT)	Speed (KIAS)	Navigation Specification
Hold	AKSEL	039 (031.2)	-7.5	1.0(-14000) 1.5(+14001)	-	R	5000	-	-230(-14000) -240(+14001)	RNAV1
Hold	SHAFT	330 (322.4)	-7.5	1.0(-14000) 1.5(+14001)	-	R	4000	-	-230(-14000) -240(+14001)	RNAV1
Hold	BACON	003 (355.2)	-7.5	1.0(-14000) 1.5(+14001)	-	L	4000	-	-230(-14000) -240(+14001)	RNAV1

CHANGE : STOWE renamed

## STANDARD ARRIVAL CHART-INSTRUMENT

RJTT / TOKYO INTL

RNAV STAR RWY22/23

AKSEL 2B ARRIVAL

From AKSEL at 12000FT, to LAFIT at or below 10000FT, to STING at or below 9000FT, to SPARK at or below 7000FT, to SHAFT at 5000FT, to BACON.

Critical DME	-
DME GAP	-
Inappropriate Nav aids	See AD1.1.6.10.3. Inappropriate NAVAIDs for RNAV1

Serial Number	Path Descriptor	Waypoint Identifier	Fly Over	Course °M(°T)	Magnetic Variation	Distance (NM)	Turn Direction	Altitude (FT)	Speed (KIAS)	Vertical Angle	Navigation Specification
001	IF	AKSEL	-	-	-7.5	-	-	12000	230	-	RNAV1
002	TF	LAFIT	-	067 (059.5)	-7.5	15.3	-	-10000	-	-	RNAV1
003	TF	STING	-	067 (059.6)	-7.5	7.0	-	-9000	-	-	RNAV1
004	TF	SPARK	-	005 (357.4)	-7.5	11.3	-	-7000	-	-	RNAV1
005	TF	SHAFT	-	005 (357.4)	-7.5	19.3	-	5000	-	-	RNAV1
006	TF	BACON	-	003 (355.2)	-7.5	9.5	-	-	-	-	RNAV1

Path	Waypoint Identifier	Inbound Course °M(°T)	Magnetic Variation	Outbound Time (MIN)	Outbound Distance (NM)	Turn Direction	Minimum Altitude (FT)	Maximum Altitude (FT)	Speed (KIAS)	Navigation Specification
Hold	AKSEL	039 (031.2)	-7.5	1.0(-14000) 1.5(+14001)	-	R	5000	-	-230(-14000) -240(+14001)	RNAV1
Hold	STING	067 (059.6)	-7.5	1.0(-14000) 1.5(+14001)	-	R	4000	-	-230(-14000) -240(+14001)	RNAV1
Hold	SHAFT	330 (322.4)	-7.5	1.0(-14000) 1.5(+14001)	-	R	4000	-	-230(-14000) -240(+14001)	RNAV1
Hold	BACON	003 (355.2)	-7.5	1.0(-14000) 1.5(+14001)	-	L	4000	-	-230(-14000) -240(+14001)	RNAV1

Waypoint Coordinates

Waypoint Identifier	Coordinates	Waypoint Identifier	Coordinates
AKSEL	344039.5N / 1395126.9E	STING	345157.9N / 1401453.4E
BACON	353155.0N / 1401215.1E	STOWE	350325.9N / 1403111.4E
LAFIT	344826.0N / 1400732.4E	TT253	350001.4N / 1400224.6E
SALLY	345333.9N / 1395540.1E	TT254	345826.5N / 1401129.4E
SHAFT	352227.4N / 1401313.3E	TT255	345910.9N / 1402041.4E
SPARK	350312.0N / 1401416.7E		

CHANGE : STOWE renamed

STANDARD ARRIVAL CHART-INSTRUMENT

RJTT / TOKYO INTL

RNAV STAR RWY22/23

GODIN 1S ARRIVAL  
GODIN 1D ARRIVAL

RNAV 1

Note 1) DME/DME/IRU or GNSS required.  
2) RADAR service required.

VAR 8° W(2019)

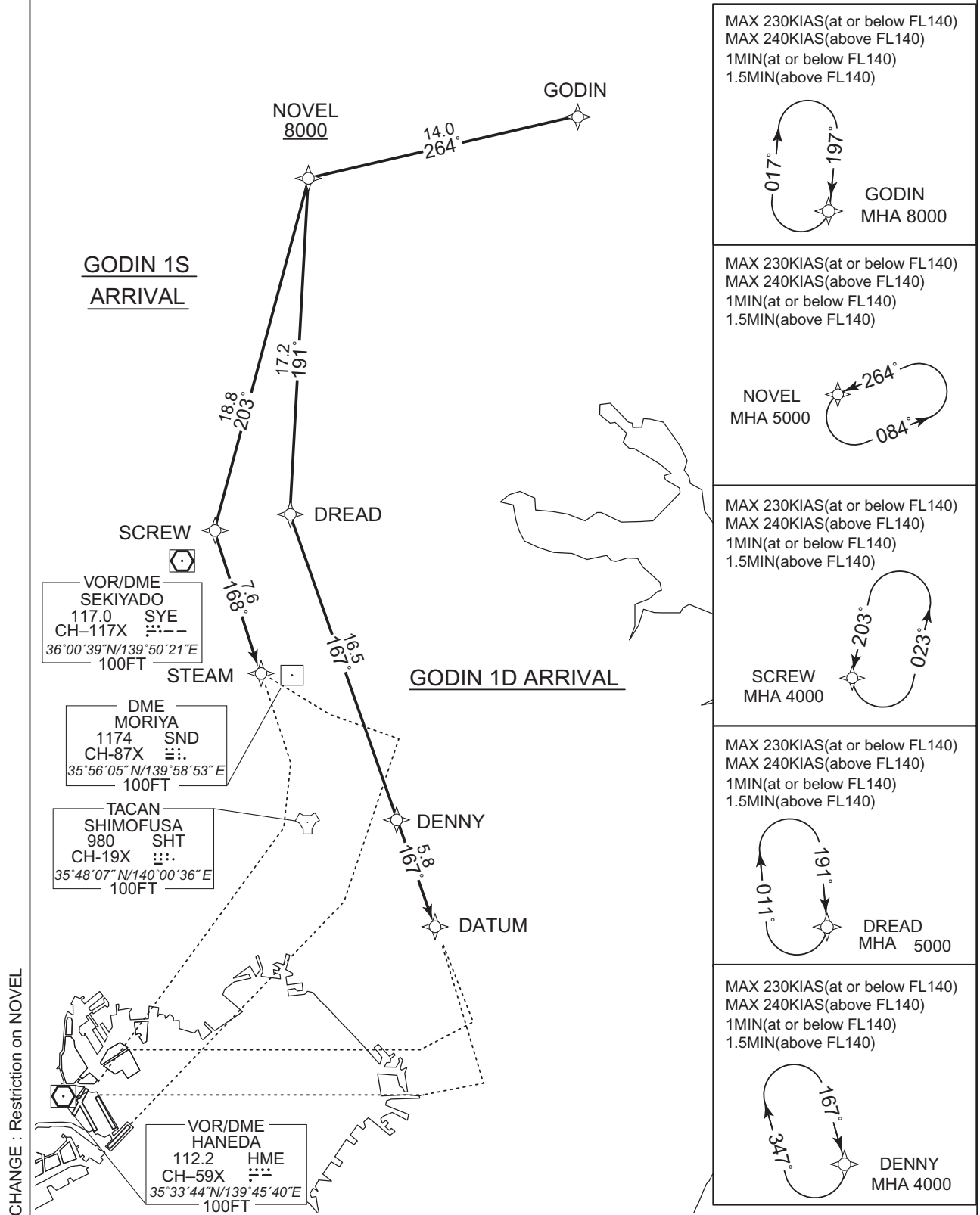

STANDARD ARRIVAL CHART-INSTRUMENT

RJTT / TOKYO INTL

RNAV STAR RWY22/23

GODIN 1S ARRIVAL

From GODIN, to NOVEL at or above 8000FT, to SCREW, to STEAM.

Critical DME	-
DME GAP	-
Inappropriate Nav aids	See AD1.1.6.10.3. Inappropriate NAVAIDs for RNAV1

Serial Number	Path Descriptor	Waypoint Identifier	Fly Over	Course °M(°T)	Magnetic Variation	Distance (NM)	Turn Direction	Altitude (FT)	Speed (KIAS)	Vertical Angle	Navigation Specification
001	IF	GODIN	-	-	-7.5	-	-	-	-	-	RNAV1
002	TF	NOVEL	-	264 (256.4)	-7.5	14.0	-	+8000	-	-	RNAV1
003	TF	SCREW	-	203 (195.2)	-7.5	18.8	-	-	-	-	RNAV1
004	TF	STEAM	-	168 (160.4)	-7.5	7.6	-	-	-	-	RNAV1

Path	Waypoint Identifier	Inbound Course °M(°T)	Magnetic Variation	Outbound Time (MIN)	Outbound Distance (NM)	Turn Direction	Minimum Altitude (FT)	Maximum Altitude (FT)	Speed (KIAS)	Navigation Specification
Hold	GODIN	197 (189.2)	-7.5	1.0(-14000) 1.5(+14001)	-	R	8000	-	-230(-14000) -240(+14001)	RNAV1
Hold	NOVEL	264 (256.4)	-7.5	1.0(-14000) 1.5(+14001)	-	L	5000	-	-230(-14000) -240(+14001)	RNAV1
Hold	SCREW	203 (195.2)	-7.5	1.0(-14000) 1.5(+14001)	-	L	4000	-	-230(-14000) -240(+14001)	RNAV1

CHANGE : Restriction on NOVEL

STANDARD ARRIVAL CHART-INSTRUMENT

RJTT / TOKYO INTL

RNAV STAR RWY22/23

GODIN 1D ARRIVAL

From GODIN, to NOVEL at or above 8000FT, to DREAD, to DENNY, to DATUM.

Critical DME	-
DME GAP	-
Inappropriate Nav aids	See AD1.1.6.10.3. Inappropriate NAVAIDs for RNAV1

Serial Number	Path Descriptor	Waypoint Identifier	Fly Over	Course °M(°T)	Magnetic Variation	Distance (NM)	Turn Direction	Altitude (FT)	Speed (KIAS)	Vertical Angle	Navigation Specification
001	IF	GODIN	-	-	-7.5	-	-	-	-	-	RNAV1
002	TF	NOVEL	-	264 (256.4)	-7.5	14.0	-	+8000	-	-	RNAV1
003	TF	DREAD	-	191 (183.1)	-7.5	17.2	-	-	-	-	RNAV1
004	TF	DENNY	-	167 (159.9)	-7.5	16.5	-	-	-	-	RNAV1
005	TF	DATUM	-	167 (160.0)	-7.5	5.8	-	-	-	-	RNAV1

Path	Waypoint Identifier	Inbound Course °M(°T)	Magnetic Variation	Outbound Time (MIN)	Outbound Distance (NM)	Turn Direction	Minimum Altitude (FT)	Maximum Altitude (FT)	Speed (KIAS)	Navigation Specification
Hold	GODIN	197 (189.2)	-7.5	1.0(-14000) 1.5(+14001)	-	R	8000	-	-230(-14000) -240(+14001)	RNAV1
Hold	NOVEL	264 (256.4)	-7.5	1.0(-14000) 1.5(+14001)	-	L	5000	-	-230(-14000) -240(+14001)	RNAV1
Hold	DREAD	191 (183.1)	-7.5	1.0(-14000) 1.5(+14001)	-	R	5000	-	-230(-14000) -240(+14001)	RNAV1
Hold	DENNY	167 (159.9)	-7.5	1.0(-14000) 1.5(+14001)	-	R	4000	-	-230(-14000) -240(+14001)	RNAV1

Waypoint Coordinates

Waypoint Identifier	Coordinates	Waypoint Identifier	Coordinates
DATUM	354259.6N / 1400824.3E	NOVEL	362106.9N / 1400004.9E
DENNY	354828.8N / 1400556.4E	SCREW	360301.2N / 1395400.4E
DREAD	360359.2N / 1395856.9E	STEAM	355553.3N / 1395708.4E
GODIN	362425.3N / 1401655.9E		

CHANGE : Restriction on NOVEL

STANDARD ARRIVAL CHART-INSTRUMENT

RJTT / TOKYO INTL

RNAV STAR RWY22/23

POLIX 1S ARRIVAL  
POLIX 1D ARRIVAL

RNAV 1

Note 1) DME/DME/IRU or GNSS required.  
2) RADAR service required.

VAR 8° W(2019)

POLIX 1S  
ARRIVAL

POLIX 1D ARRIVAL

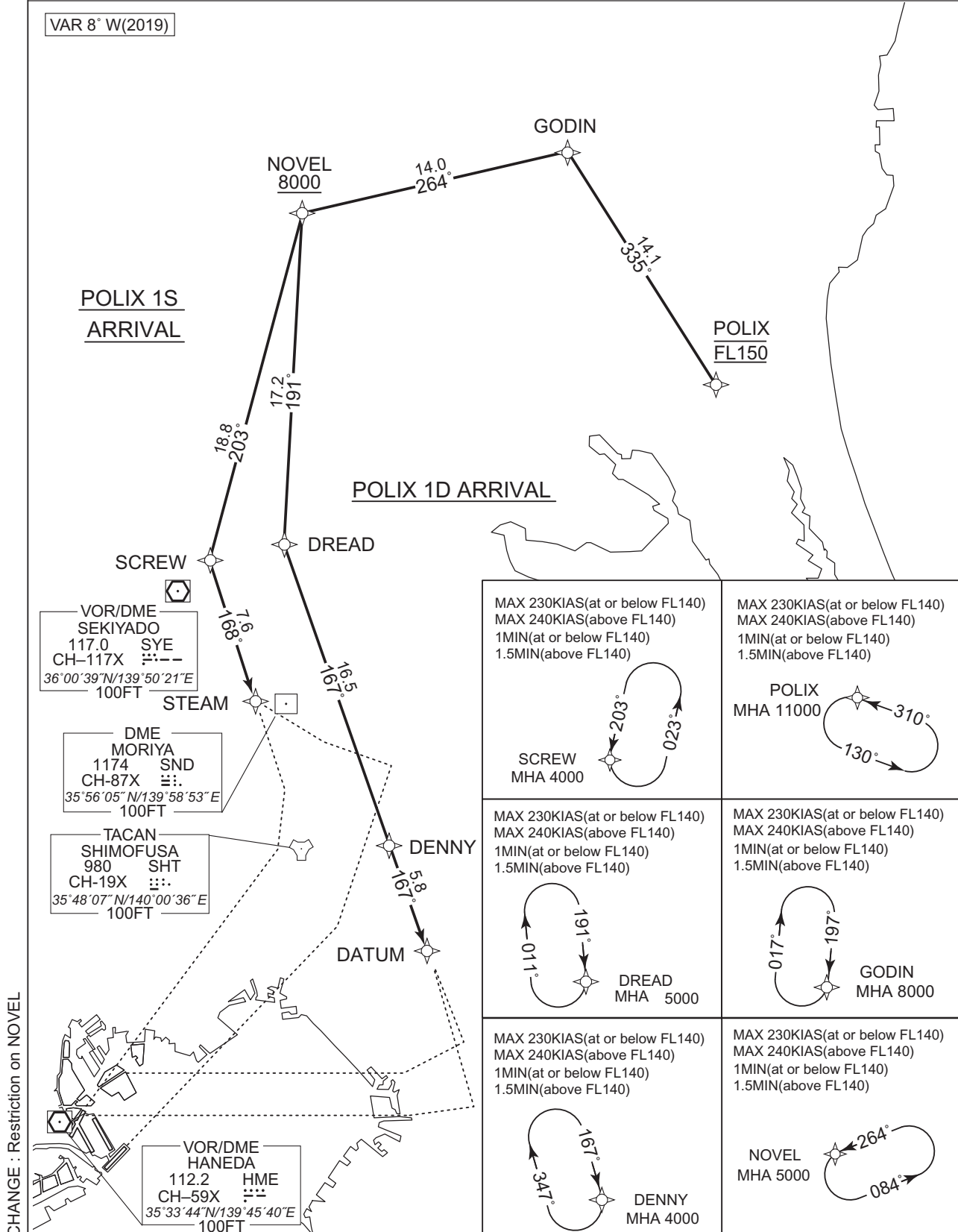

STANDARD ARRIVAL CHART-INSTRUMENT

RJTT / TOKYO INTL

RNAV STAR RWY22/23

POLIX 1S ARRIVAL

From POLIX at FL150, to GODIN, to NOVEL at or above 8000FT, to SCREW, to STEAM.

Critical DME	-
DME GAP	-
Inappropriate Nav aids	See AD1.1.6.10.3. Inappropriate NAVAIDs for RNAV1

Serial Number	Path Descriptor	Waypoint Identifier	Fly Over	Course °M(°T)	Magnetic Variation	Distance (NM)	Turn Direction	Altitude (FT)	Speed (KIAS)	Vertical Angle	Navigation Specification
001	IF	POLIX	-	-	-7.5	-	-	FL150	-	-	RNAV1
002	TF	GODIN	-	335 (327.2)	-7.5	14.1	-	-	-	-	RNAV1
003	TF	NOVEL	-	264 (256.4)	-7.5	14.0	-	+8000	-	-	RNAV1
004	TF	SCREW	-	203 (195.2)	-7.5	18.8	-	-	-	-	RNAV1
005	TF	STEAM	-	168 (160.4)	-7.5	7.6	-	-	-	-	RNAV1

Path	Waypoint Identifier	Inbound Course °M(°T)	Magnetic Variation	Outbound Time (MIN)	Outbound Distance (NM)	Turn Direction	Minimum Altitude (FT)	Maximum Altitude (FT)	Speed (KIAS)	Navigation Specification
Hold	POLIX	310 (302.3)	-7.5	1.0(-14000) 1.5(+14001)	-	L	11000	-	-230(-14000) -240(+14001)	RNAV1
Hold	GODIN	197 (189.2)	-7.5	1.0(-14000) 1.5(+14001)	-	R	8000	-	-230(-14000) -240(+14001)	RNAV1
Hold	NOVEL	264 (256.4)	-7.5	1.0(-14000) 1.5(+14001)	-	L	5000	-	-230(-14000) -240(+14001)	RNAV1
Hold	SCREW	203 (195.2)	-7.5	1.0(-14000) 1.5(+14001)	-	L	4000	-	-230(-14000) -240(+14001)	RNAV1

CHANGE : Restriction on NOVEL

STANDARD ARRIVAL CHART-INSTRUMENT

RJTT / TOKYO INTL

RNAV STAR RWY22/23

POLIX 1D ARRIVAL

From POLIX at FL150, to GODIN, to NOVEL at or above 8000FT, to DREAD, to DENNY, to DATUM.

Critical DME	-
DME GAP	-
Inappropriate Nav aids	See AD1.1.6.10.3. Inappropriate NAVAIDs for RNAV1

Serial Number	Path Descriptor	Waypoint Identifier	Fly Over	Course °M(°T)	Magnetic Variation	Distance (NM)	Turn Direction	Altitude (FT)	Speed (KIAS)	Vertical Angle	Navigation Specification
001	IF	POLIX	-	-	-7.5	-	-	FL150	-	-	RNAV1
002	TF	GODIN	-	335 (327.2)	-7.5	14.1	-	-	-	-	RNAV1
003	TF	NOVEL	-	264 (256.4)	-7.5	14.0	-	+8000	-	-	RNAV1
004	TF	DREAD	-	191 (183.1)	-7.5	17.2	-	-	-	-	RNAV1
005	TF	DENNY	-	167 (159.9)	-7.5	16.5	-	-	-	-	RNAV1
006	TF	DATUM	-	167 (160.0)	-7.5	5.8	-	-	-	-	RNAV1

Path	Waypoint Identifier	Inbound Course °M(°T)	Magnetic Variation	Outbound Time (MIN)	Outbound Distance (NM)	Turn Direction	Minimum Altitude (FT)	Maximum Altitude (FT)	Speed (KIAS)	Navigation Specification
Hold	POLIX	310 (302.3)	-7.5	1.0(-14000) 1.5(+14001)	-	L	11000	-	-230(-14000) -240(+14001)	RNAV1
Hold	GODIN	197 (189.2)	-7.5	1.0(-14000) 1.5(+14001)	-	R	8000	-	-230(-14000) -240(+14001)	RNAV1
Hold	NOVEL	264 (256.4)	-7.5	1.0(-14000) 1.5(+14001)	-	L	5000	-	-230(-14000) -240(+14001)	RNAV1
Hold	DREAD	191 (183.1)	-7.5	1.0(-14000) 1.5(+14001)	-	R	5000	-	-230(-14000) -240(+14001)	RNAV1
Hold	DENNY	167 (159.9)	-7.5	1.0(-14000) 1.5(+14001)	-	R	4000	-	-230(-14000) -240(+14001)	RNAV1

Waypoint Coordinates

Waypoint Identifier	Coordinates	Waypoint Identifier	Coordinates
DATUM	354259.6N / 1400824.3E	NOVEL	362106.9N / 1400004.9E
DENNY	354828.8N / 1400556.4E	POLIX	361237.1N / 1402622.5E
DREAD	360359.2N / 1395856.9E	SCREW	360301.2N / 1395400.4E
GODIN	362425.3N / 1401655.9E	STEAM	355553.3N / 1395708.4E

CHANGE : Restriction on NOVEL



STANDARD ARRIVAL CHART-INSTRUMENT

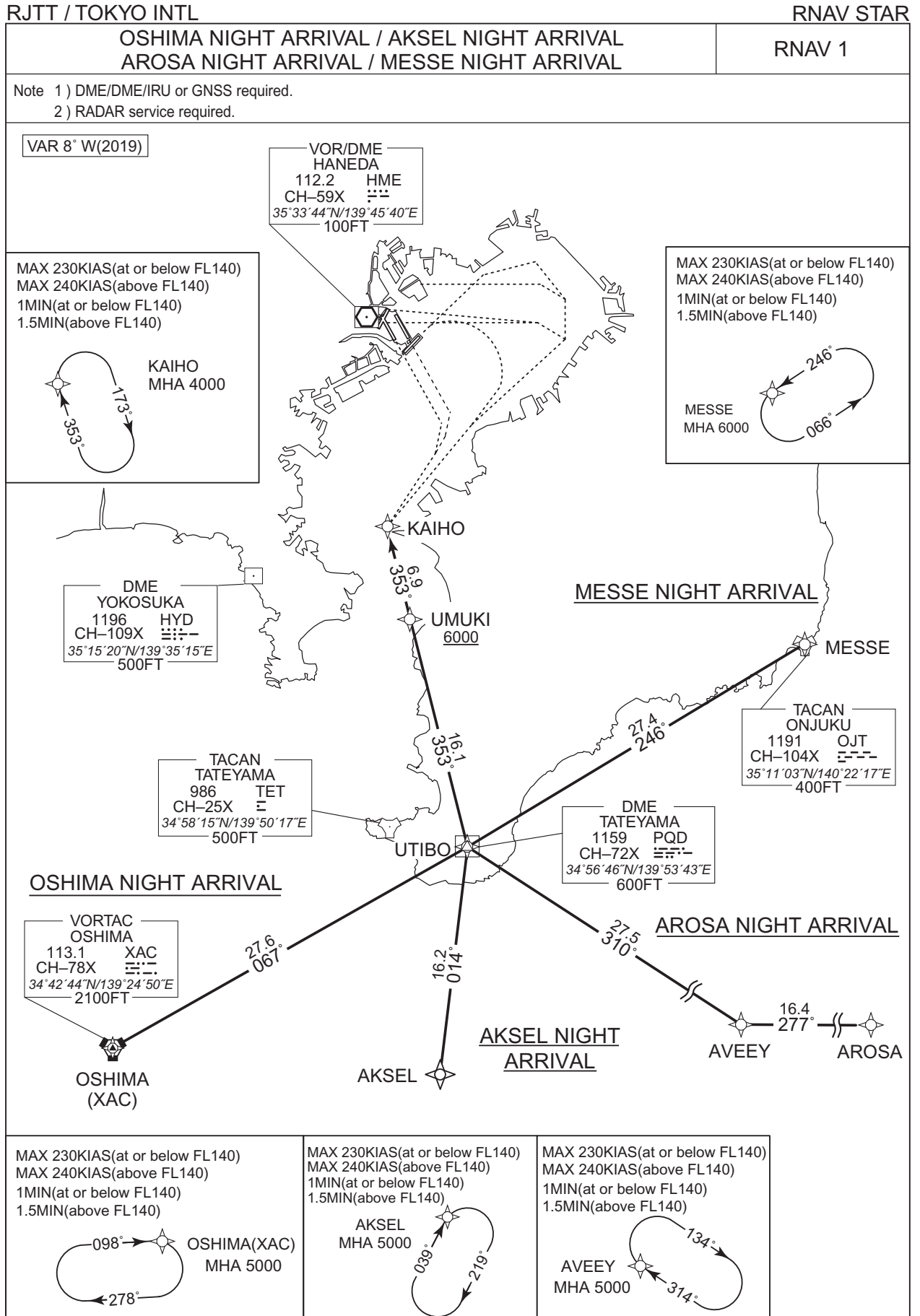

## STANDARD ARRIVAL CHART-INSTRUMENT

RJTT / TOKYO INTL

RNAV STAR

OSHIMA NIGHT ARRIVAL

From XAC, to UTIBO, to UMUKI at or above 6000FT, to KAIHO.

Critical DME	—
DME GAP	—
Inappropriate Nav aids	See AD1.1.6.10.3. Inappropriate NAVAIDs for RNAV1

Serial Number	Path Descriptor	Waypoint Identifier	Fly Over	Course °M(°T)	Magnetic Variation	Distance (NM)	Turn Direction	Altitude (FT)	Speed (KIAS)	Vertical Angle	Navigation Specification
001	IF	XAC	—	—	-7.5	—	—	—	—	—	RNAV1
002	TF	UTIBO	—	067 (059.2)	-7.5	27.6	—	—	—	—	RNAV1
003	TF	UMUKI	—	353 (345.5)	-7.5	16.1	—	+6000	—	—	RNAV1
004	TF	KAIHO	—	353 (345.5)	-7.5	6.9	—	—	—	—	RNAV1

Path	Waypoint Identifier	Inbound Course °M(°T)	Magnetic Variation	Outbound Time (MIN)	Outbound Distance (NM)	Turn Direction	Minimum Altitude (FT)	Maximum Altitude (FT)	Speed (KIAS)	Navigation Specification
Hold	XAC	098 (090.3)	-7.5	1.0(-14000) 1.5(+14001)	—	R	5000	—	-230(-14000) -240(+14001)	RNAV1
Hold	KAIHO	353 (345.5)	-7.5	1.0(-14000) 1.5(+14001)	—	R	4000	—	-230(-14000) -240(+14001)	RNAV1

STANDARD ARRIVAL CHART-INSTRUMENT

RJTT / TOKYO INTL

RNAV STAR

AKSEL NIGHT ARRIVAL

From AKSEL, to UTIBO, to UMUKI at or above 6000FT, to KAIHO.

Critical DME	-
DME GAP	-
Inappropriate Navaids	See AD1.1.6.10.3. Inappropriate NAVAIDs for RNAV1

Serial Number	Path Descriptor	Waypoint Identifier	Fly Over	Course °M(°T)	Magnetic Variation	Distance (NM)	Turn Direction	Altitude (FT)	Speed (KIAS)	Vertical Angle	Navigation Specification
001	IF	AKSEL	-	-	-7.5	-	-	-	-	-	RNAV1
002	TF	UTIBO	-	014 (006.6)	-7.5	16.2	-	-	-	-	RNAV1
003	TF	UMUKI	-	353 (345.5)	-7.5	16.1	-	+6000	-	-	RNAV1
004	TF	KAIHO	-	353 (345.5)	-7.5	6.9	-	-	-	-	RNAV1

Path	Waypoint Identifier	Inbound Course °M(°T)	Magnetic Variation	Outbound Time (MIN)	Outbound Distance (NM)	Turn Direction	Minimum Altitude (FT)	Maximum Altitude (FT)	Speed (KIAS)	Navigation Specification
Hold	AKSEL	039 (031.2)	-7.5	1.0(-14000) 1.5(+14001)	-	R	5000	-	-230(-14000) -240(+14001)	RNAV1
Hold	KAIHO	353 (345.5)	-7.5	1.0(-14000) 1.5(+14001)	-	R	4000	-	-230(-14000) -240(+14001)	RNAV1

## STANDARD ARRIVAL CHART-INSTRUMENT

RJTT / TOKYO INTL

RNAV STAR

AROSA NIGHT ARRIVAL

From AROSA, to AVEEY, to UTIBO, to UMUKI at or above 6000FT, to KAIHO.

Critical DME	—
DME GAP	—
Inappropriate Navaids	See AD1.1.6.10.3. Inappropriate NAVAIDS for RNAV1

Serial Number	Path Descriptor	Waypoint Identifier	Fly Over	Course °M(°T)	Magnetic Variation	Distance (NM)	Turn Direction	Altitude (FT)	Speed (KIAS)	Vertical Angle	Navigation Specification
001	IF	AROSA	—	—	-7.5	—	—	—	—	—	RNAV1
002	TF	AVEEY	—	277 (269.8)	-7.5	16.4	—	—	—	—	RNAV1
003	TF	UTIBO	—	310 (302.8)	-7.5	27.5	—	—	—	—	RNAV1
004	TF	UMUKI	—	353 (345.5)	-7.5	16.1	—	+6000	—	—	RNAV1
005	TF	KAIHO	—	353 (345.5)	-7.5	6.9	—	—	—	—	RNAV1

Path	Waypoint Identifier	Inbound Course °M(°T)	Magnetic Variation	Outbound Time (MIN)	Outbound Distance (NM)	Turn Direction	Minimum Altitude (FT)	Maximum Altitude (FT)	Speed (KIAS)	Navigation Specification
Hold	AVEEY	314 (306.1)	-7.5	1.0(-14000) 1.5(+14001)	—	R	5000	—	-230(-14000) -240(+14001)	RNAV1
Hold	KAIHO	353 (345.5)	-7.5	1.0(-14000) 1.5(+14001)	—	R	4000	—	-230(-14000) -240(+14001)	RNAV1

STANDARD ARRIVAL CHART-INSTRUMENT

RJTT / TOKYO INTL

RNAV STAR

MESSE NIGHT ARRIVAL

From MESSE, to UTIBO, to UMUKI at or above 6000FT, to KAIHO.

Critical DME	-
DME GAP	-
Inappropriate Navaids	See AD1.1.6.10.3. Inappropriate NAVAIDs for RNAV1

Serial Number	Path Descriptor	Waypoint Identifier	Fly Over	Course °M(°T)	Magnetic Variation	Distance (NM)	Turn Direction	Altitude (FT)	Speed (KIAS)	Vertical Angle	Navigation Specification
001	IF	MESSE	-	-	-7.5	-	-	-	-	-	RNAV1
002	TF	UTIBO	-	246 (238.8)	-7.5	27.4	-	-	-	-	RNAV1
003	TF	UMUKI	-	353 (345.5)	-7.5	16.1	-	+6000	-	-	RNAV1
004	TF	KAIHO	-	353 (345.5)	-7.5	6.9	-	-	-	-	RNAV1

Path	Waypoint Identifier	Inbound Course °M(°T)	Magnetic Variation	Outbound Time (MIN)	Outbound Distance (NM)	Turn Direction	Minimum Altitude (FT)	Maximum Altitude (FT)	Speed (KIAS)	Navigation Specification
Hold	MESSE	246 (238.8)	-7.5	1.0(-14000) 1.5(+14001)	-	L	6000	-	-230(-14000) -240(+14001)	RNAV1
Hold	KAIHO	353 (345.5)	-7.5	1.0(-14000) 1.5(+14001)	-	R	4000	-	-230(-14000) -240(+14001)	RNAV1

Waypoint Coordinates

Waypoint Identifier	Coordinates	Waypoint Identifier	Coordinates
AKSEL	344039.5N / 1395126.9E	MESSE	351100.8N / 1402214.7E
AROSA	344201.7N / 1404157.3E	UMUKI	351219.1N / 1394849.2E
AVEEY	344155.9N / 1402158.0E	UTIBO	345647.0N / 1395343.9E
KAIHO	351857.8N / 1394642.4E	XAC	344244.1N / 1392450.5E

STANDARD ARRIVAL CHART-INSTRUMENT

RJTT / TOKYO INTL

RNAV STAR

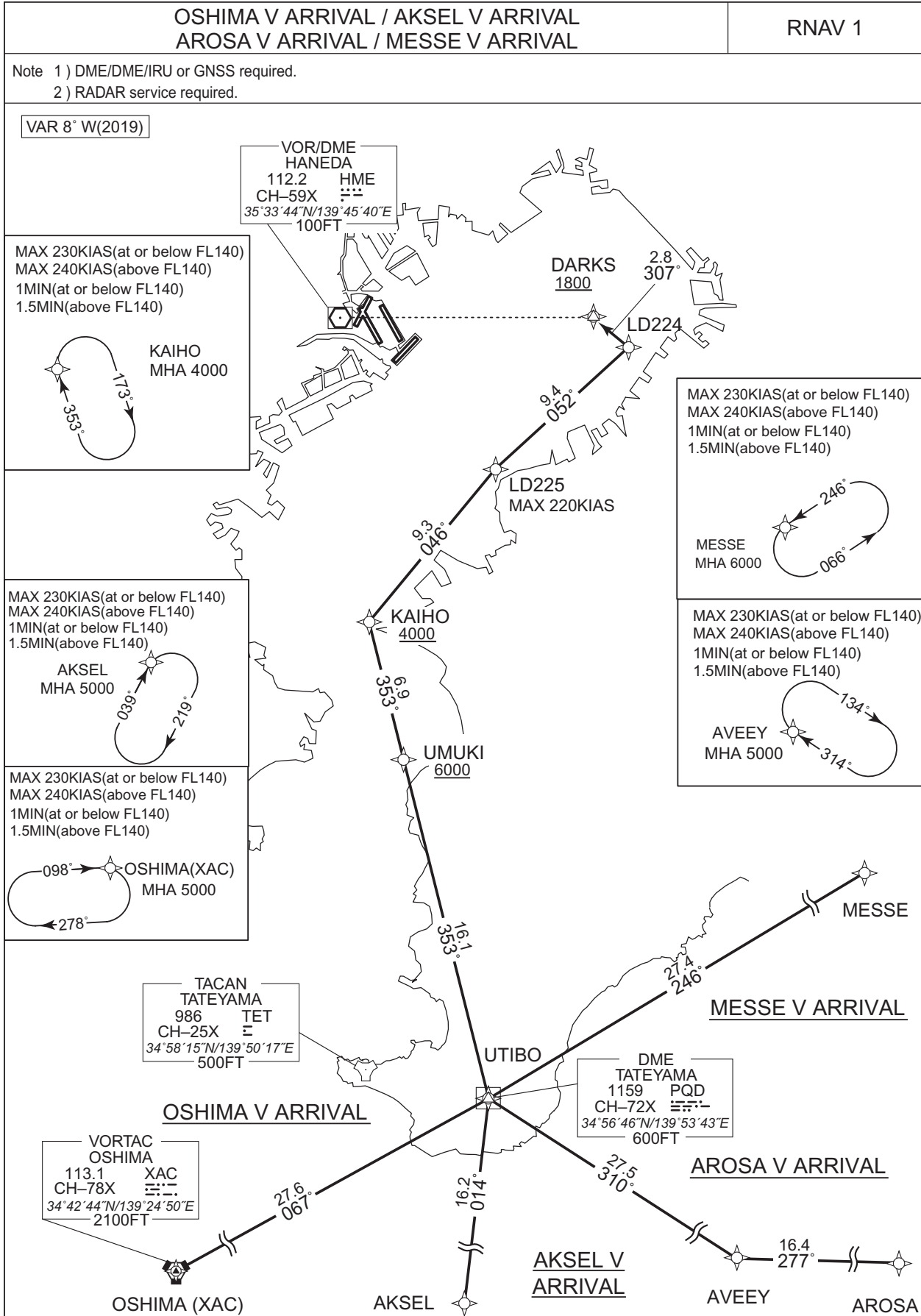

STANDARD ARRIVAL CHART-INSTRUMENT

RJTT / TOKYO INTL

RNAV STAR

OSHIMA V ARRIVAL

From XAC, to UTIBO, to UMUKI at or above 6000FT, to KAIHO at or above 4000FT, to LD225, to LD224, to DARKS at or above 1800FT.

Critical DME	-
DME GAP	-
Inappropriate Nav aids	See AD1.1.6.10.3. Inappropriate NAVAIDs for RNAV1

Serial Number	Path Descriptor	Waypoint Identifier	Fly Over	Course °M(°T)	Magnetic Variation	Distance (NM)	Turn Direction	Altitude (FT)	Speed (KIAS)	Vertical Angle	Navigation Specification
001	IF	XAC	-	-	-7.5	-	-	-	-	-	RNAV1
002	TF	UTIBO	-	067 (059.2)	-7.5	27.6	-	-	-	-	RNAV1
003	TF	UMUKI	-	353 (345.5)	-7.5	16.1	-	+6000	-	-	RNAV1
004	TF	KAIHO	-	353 (345.5)	-7.5	6.9	-	+4000	-	-	RNAV1
005	TF	LD225	-	046 (038.9)	-7.5	9.3	-	-	-220	-	RNAV1
006	TF	LD224	-	052 (044.9)	-7.5	9.4	-	-	-	-	RNAV1
007	TF	DARKS	-	307 (299.7)	-7.5	2.8	-	+1800	-	-	RNAV1

Path	Waypoint Identifier	Inbound Course °M(°T)	Magnetic Variation	Outbound Time (MIN)	Outbound Distance (NM)	Turn Direction	Minimum Altitude (FT)	Maximum Altitude (FT)	Speed (KIAS)	Navigation Specification
Hold	XAC	098 (090.3)	-7.5	1.0(-14000) 1.5(+14001)	-	R	5000	-	-230(-14000) -240(+14001)	RNAV1
Hold	KAIHO	353 (345.5)	-7.5	1.0(-14000) 1.5(+14001)	-	R	4000	-	-230(-14000) -240(+14001)	RNAV1

## STANDARD ARRIVAL CHART-INSTRUMENT

RJTT / TOKYO INTL

RNAV STAR

AKSEL V ARRIVAL

From AKSEL, to UTIBO, to UMUKI at or above 6000FT, to KAIHO at or above 4000FT, to LD225, to LD224, to DARKS at or above 1800FT.

Critical DME	-
DME GAP	-
Inappropriate Nav aids	See AD1.1.6.10.3. Inappropriate NAVAIDs for RNAV1

Serial Number	Path Descriptor	Waypoint Identifier	Fly Over	Course °M(°T)	Magnetic Variation	Distance (NM)	Turn Direction	Altitude (FT)	Speed (KIAS)	Vertical Angle	Navigation Specification
001	IF	AKSEL	-	-	-7.5	-	-	-	-	-	RNAV1
002	TF	UTIBO	-	014 (006.6)	-7.5	16.2	-	-	-	-	RNAV1
003	TF	UMUKI	-	353 (345.5)	-7.5	16.1	-	+6000	-	-	RNAV1
004	TF	KAIHO	-	353 (345.5)	-7.5	6.9	-	+4000	-	-	RNAV1
005	TF	LD225	-	046 (038.9)	-7.5	9.3	-	-	-220	-	RNAV1
006	TF	LD224	-	052 (044.9)	-7.5	9.4	-	-	-	-	RNAV1
007	TF	DARKS	-	307 (299.7)	-7.5	2.8	-	+1800	-	-	RNAV1

Path	Waypoint Identifier	Inbound Course °M(°T)	Magnetic Variation	Outbound Time (MIN)	Outbound Distance (NM)	Turn Direction	Minimum Altitude (FT)	Maximum Altitude (FT)	Speed (KIAS)	Navigation Specification
Hold	AKSEL	039 (031.2)	-7.5	1.0(-14000) 1.5(+14001)	-	R	5000	-	-230(-14000) -240(+14001)	RNAV1
Hold	KAIHO	353 (345.5)	-7.5	1.0(-14000) 1.5(+14001)	-	R	4000	-	-230(-14000) -240(+14001)	RNAV1



STANDARD ARRIVAL CHART-INSTRUMENT

RJTT / TOKYO INTL

RNAV STAR

AROSA V ARRIVAL

From AROSA, to AVEEY, to UTIBO, to UMUKI at or above 6000FT, to KAIHO at or above 4000FT, to LD225, to LD224, to DARKS at or above 1800FT.

Critical DME	-
DME GAP	-
Inappropriate Nav aids	See AD1.1.6.10.3. Inappropriate NAVAIDs for RNAV1

Serial Number	Path Descriptor	Waypoint Identifier	Fly Over	Course °M(°T)	Magnetic Variation	Distance (NM)	Turn Direction	Altitude (FT)	Speed (KIAS)	Vertical Angle	Navigation Specification
001	IF	AROSA	-	-	-7.5	-	-	-	-	-	RNAV1
002	TF	AVEEY	-	277 (269.8)	-7.5	16.4	-	-	-	-	RNAV1
003	TF	UTIBO	-	310 (302.8)	-7.5	27.5	-	-	-	-	RNAV1
004	TF	UMUKI	-	353 (345.5)	-7.5	16.1	-	+6000	-	-	RNAV1
005	TF	KAIHO	-	353 (345.5)	-7.5	6.9	-	+4000	-	-	RNAV1
006	TF	LD225	-	046 (038.9)	-7.5	9.3	-	-	-220	-	RNAV1
007	TF	LD224	-	052 (044.9)	-7.5	9.4	-	-	-	-	RNAV1
008	TF	DARKS	-	307 (299.7)	-7.5	2.8	-	+1800	-	-	RNAV1

Path	Waypoint Identifier	Inbound Course °M(°T)	Magnetic Variation	Outbound Time (MIN)	Outbound Distance (NM)	Turn Direction	Minimum Altitude (FT)	Maximum Altitude (FT)	Speed (KIAS)	Navigation Specification
Hold	AVEEY	314 (306.1)	-7.5	1.0(-14000) 1.5(+14001)	-	R	5000	-	-230(-14000) -240(+14001)	RNAV1
Hold	KAIHO	353 (345.5)	-7.5	1.0(-14000) 1.5(+14001)	-	R	4000	-	-230(-14000) -240(+14001)	RNAV1

STANDARD ARRIVAL CHART-INSTRUMENT

RJTT / TOKYO INTL

RNAV STAR

MESSE V ARRIVAL

From MESSE, to UTIBO, to UMUKI at or above 6000FT, to KAIHO at or above 4000FT, to LD225, to LD224, to DARKS at or above 1800FT.

Critical DME	-
DME GAP	-
Inappropriate Nav aids	See AD1.1.6.10.3. Inappropriate NAVAIDS for RNAV1

Serial Number	Path Descriptor	Waypoint Identifier	Fly Over	Course °M(°T)	Magnetic Variation	Distance (NM)	Turn Direction	Altitude (FT)	Speed (KIAS)	Vertical Angle	Navigation Specification
001	IF	MESSE	-	-	-7.5	-	-	-	-	-	RNAV1
002	TF	UTIBO	-	246 (238.8)	-7.5	27.4	-	-	-	-	RNAV1
003	TF	UMUKI	-	353 (345.5)	-7.5	16.1	-	+6000	-	-	RNAV1
004	TF	KAIHO	-	353 (345.5)	-7.5	6.9	-	+4000	-	-	RNAV1
005	TF	LD225	-	046 (038.9)	-7.5	9.3	-	-	-220	-	RNAV1
006	TF	LD224	-	052 (044.9)	-7.5	9.4	-	-	-	-	RNAV1
007	TF	DARKS	-	307 (299.7)	-7.5	2.8	-	+1800	-	-	RNAV1

Path	Waypoint Identifier	Inbound Course °M(°T)	Magnetic Variation	Outbound Time (MIN)	Outbound Distance (NM)	Turn Direction	Minimum Altitude (FT)	Maximum Altitude (FT)	Speed (KIAS)	Navigation Specification
Hold	MESSE	246 (238.8)	-7.5	1.0(-14000) 1.5(+14001)	-	L	6000	-	-230(-14000) -240(+14001)	RNAV1
Hold	KAIHO	353 (345.5)	-7.5	1.0(-14000) 1.5(+14001)	-	R	4000	-	-230(-14000) -240(+14001)	RNAV1

Waypoint Coordinates

Waypoint Identifier	Coordinates	Waypoint Identifier	Coordinates
AKSEL	344039.5N / 1395126.9E	LD225	352614.1N / 1395353.4E
AROSA	344201.7N / 1404157.3E	MESSE	351100.8N / 1402214.7E
AVEEY	344155.9N / 1402158.0E	UMUKI	351219.1N / 1394849.2E
DARKS	353414.8N / 1395902.9E	UTIBO	345647.0N / 1395343.9E
KAIHO	351857.8N / 1394642.4E	XAC	344244.1N / 1392450.5E
LD224	353252.5N / 1400200.0E		

RJTT / TOKYO INTL

RNAV HLDG PATTERN

Note 1) DME/DME/IRU or GNSS required.  
2) RADAR service required.

RNAV 1

1.Outbound Time / Distance  
2.Speed  
→See Tabular Description.

<p>ARLON MHA 4000</p>	<p>BACON MHA 4000</p>
<p>COACH MHA 4000</p>	<p>CREAM MHA 4000</p>
<p>DREAD MHA 5000</p>	<p>MESSE MHA 6000</p>
<p>SCREW MHA 4000</p>	<p>STING MHA 4000</p>
<p>NUMAN MHA 4000</p>	
<p>NEURO MHA 4000</p>	

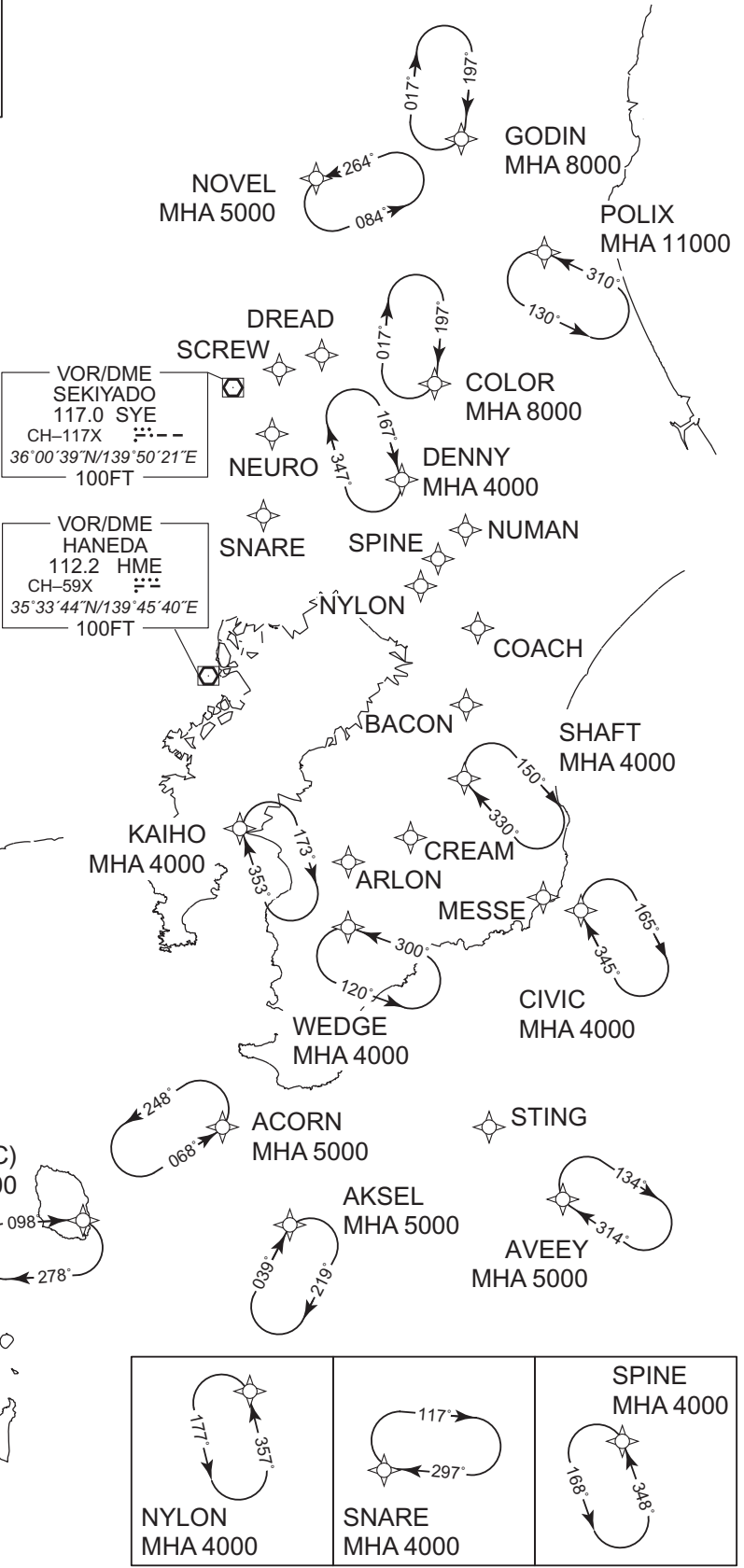

CHANGE : NEURO, NUMAN, SNARE, SPINE established

RJTT / TOKYO INTL

RNAV HLDG PATTERN

Path	Waypoint Identifier	Inbound Course M(°T)	Magnetic Variation	Outbound Time (MIN)	Outbound Distance (NM)	Turn Direction	Minimum Altitude (FT)	Maximum Altitude (FT)	Speed (KIAS)	Navigation Specification
Hold	ACORN	068 (060.8)	-7.5	1.0(-14000) 1.5(+14001)	-	L	5000	-	-230(-14000) -240(+14001)	RNAV1
Hold	AKSEL	039 (031.2)	-7.5	1.0(-14000) 1.5(+14001)	-	R	5000	-	-230(-14000) -240(+14001)	RNAV1
Hold	ARLON	009 (001.6)	-7.5	1.0(-14000) 1.5(+14001)	-	L	4000	-	-230(-14000) -240(+14001)	RNAV1
Hold	AVEEY	314 (306.1)	-7.5	1.0(-14000) 1.5(+14001)	-	R	5000	-	-230(-14000) -240(+14001)	RNAV1
Hold	BACON	003 (355.2)	-7.5	1.0(-14000) 1.5(+14001)	-	L	4000	-	-230(-14000) -240(+14001)	RNAV1
Hold	CIVIC	345 (337.7)	-7.5	1.0(-14000) 1.5(+14001)	-	R	4000	-	-230(-14000) -240(+14001)	RNAV1
Hold	COACH	185 (177.8)	-7.5	1.0(-14000) 1.5(+14001)	-	R	4000	-	-230(-14000) -240(+14001)	RNAV1
Hold	COLOR	197 (189.1)	-7.5	1.0(-14000) 1.5(+14001)	-	R	8000	-	-230(-14000) -240(+14001)	RNAV1
Hold	CREAM	291 (283.1)	-7.5	1.0(-14000) 1.5(+14001)	-	R	4000	-	-230(-14000) -240(+14001)	RNAV1
Hold	DENNY	167 (159.9)	-7.5	1.0(-14000) 1.5(+14001)	-	R	4000	-	-230(-14000) -240(+14001)	RNAV1
Hold	DREAD	191 (183.1)	-7.5	1.0(-14000) 1.5(+14001)	-	R	5000	-	-230(-14000) -240(+14001)	RNAV1
Hold	GODIN	197 (189.2)	-7.5	1.0(-14000) 1.5(+14001)	-	R	8000	-	-230(-14000) -240(+14001)	RNAV1
Hold	KAIHO	353 (345.5)	-7.5	1.0(-14000) 1.5(+14001)	-	R	4000	-	-230(-14000) -240(+14001)	RNAV1
Hold	MESSE	246 (238.8)	-7.5	1.0(-14000) 1.5(+14001)	-	L	6000	-	-230(-14000) -240(+14001)	RNAV1
Hold	NEURO	290 (282.9)	-7.5	1.0(-14000) 1.5(+14001)	-	R	4000	-	-230(-14000) -240(+14001)	RNAV1
Hold	NOVEL	264 (256.4)	-7.5	1.0(-14000) 1.5(+14001)	-	L	5000	-	-230(-14000) -240(+14001)	RNAV1
Hold	NUMAN	360 (352.5)	-7.5	1.0(-14000) 1.5(+14001)	-	L	4000	-	-230(-14000) -240(+14001)	RNAV1
Hold	NYLON	357 (350.0)	-7.5	1.0(-14000) 1.5(+14001)	-	L	4000	-	-230(-14000) -240(+14001)	RNAV1
Hold	POLIX	310 (302.3)	-7.5	1.0(-14000) 1.5(+14001)	-	L	11000	-	-230(-14000) -240(+14001)	RNAV1
Hold	SCREW	203 (195.2)	-7.5	1.0(-14000) 1.5(+14001)	-	L	4000	-	-230(-14000) -240(+14001)	RNAV1
Hold	SHAFT	330 (322.4)	-7.5	1.0(-14000) 1.5(+14001)	-	R	4000	-	-230(-14000) -240(+14001)	RNAV1
Hold	SNARE	297 (289.1)	-7.5	1.0(-14000) 1.5(+14001)	-	R	4000	-	-230(-14000) -240(+14001)	RNAV1
Hold	SPINE	348 (340.6)	-7.5	1.0(-14000) 1.5(+14001)	-	L	4000	-	-230(-14000) -240(+14001)	RNAV1
Hold	STING	067 (059.6)	-7.5	1.0(-14000) 1.5(+14001)	-	R	4000	-	-230(-14000) -240(+14001)	RNAV1
Hold	WEDGE	300 (292.4)	-7.5	1.0(-14000) 1.5(+14001)	-	L	4000	-	-230(-14000) -240(+14001)	RNAV1
Hold	XAC	098 (090.3)	-7.5	1.0(-14000) 1.5(+14001)	-	R	5000	-	-230(-14000) -240(+14001)	RNAV1

CHANGE : NEURO, NUMAN, SNARE, SPINE established

RJTT / TOKYO INTL

RNAV HLDG PATTERN

Waypoint Coordinates

Waypoint Identifier	Coordinates	Waypoint Identifier	Coordinates
ACORN	345028.8N / 1394146.7E	MESSE	351100.8N / 1402214.7E
AKSEL	344039.5N / 1395126.9E	NEURO	355727.6N / 1395441.3E
ARLON	351525.3N / 1395859.8E	NOVEL	362106.9N / 1400004.9E
AVEEY	344155.9N / 1402158.0E	NUMAN	354714.4N / 1401204.9E
BACON	353155.0N / 1401215.1E	NYLON	354018.5N / 1400919.9E
CIVIC	350840.6N / 1402552.1E	POLIX	361237.1N / 1402622.5E
COACH	353736.0N / 1401231.5E	SCREW	360301.2N / 1395400.4E
COLOR	360116.3N / 1401219.8E	SHAFT	352227.4N / 1401313.3E
CREAM	351743.4N / 1400612.4E	SNARE	354731.1N / 1395238.1E
DENNY	354828.8N / 1400556.4E	SPINE	354213.5N / 1401125.8E
DREAD	360359.2N / 1395856.9E	STING	345157.9N / 1401453.4E
GODIN	362425.3N / 1401655.9E	WEDGE	350900.4N / 1395846.5E
KAIHO	351857.8N / 1394642.4E	XAC	344244.1N / 1392450.5E

CHANGE : NEURO, NUMAN, SNARE, SPINE established

STANDARD ARRIVAL CHART-INSTRUMENT

RJTT / TOKYO INTL

RNAV STAR RWY16L/16R

OSHIMA L ARRIVAL  
OSHIMA R ARRIVAL

RNAV 1

Note 1) DME/DME/IRU or GNSS required.  
2) RADAR service required.

VAR 8° W(2019)

MAX 230KIAS(at or below FL140)  
MAX 240KIAS(above FL140)  
1MIN(at or below FL140)  
1.5MIN(above FL140)

MAX 230KIAS(at or below FL140)  
MAX 240KIAS(above FL140)  
1MIN(at or below FL140)  
1.5MIN(above FL140)

MAX 230KIAS(at or below FL140)  
MAX 240KIAS(above FL140)  
1MIN(at or below FL140)  
1.5MIN(above FL140)

MAX 230KIAS(at or below FL140)  
MAX 240KIAS(above FL140)  
1MIN(at or below FL140)  
1.5MIN(above FL140)

MAX 230KIAS(at or below FL140)  
MAX 240KIAS(above FL140)  
1MIN(at or below FL140)  
1.5MIN(above FL140)

MAX 230KIAS(at or below FL140)  
MAX 240KIAS(above FL140)  
1MIN(at or below FL140)  
1.5MIN(above FL140)

VOR/DME  
HANEDA  
112.2 HME  
CH-59X  
35°33'44"N/139°45'40"E  
100FT

OSHIMA R ARRIVAL

OSHIMA L ARRIVAL

OSHIMA L ARRIVAL

OSHIMA R ARRIVAL

CHANGE : New PROC

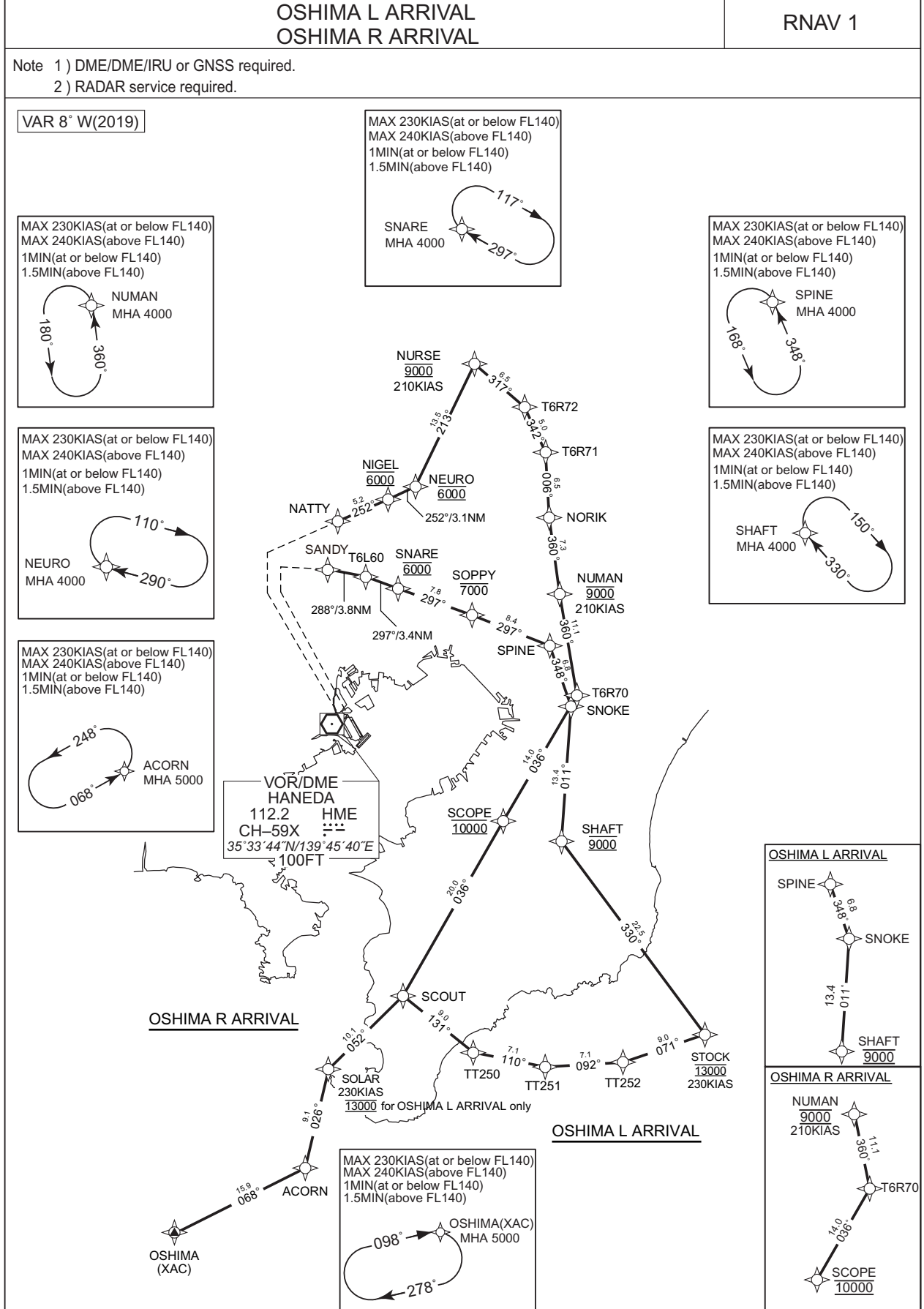

STANDARD ARRIVAL CHART-INSTRUMENT

RJTT / TOKYO INTL

RNAV STAR RWY16L/16R

OSHIMA L ARRIVAL

From XAC, to ACORN, to SOLAR at 13000FT, to SCOUT, to TT250, to TT251, to TT252, to STOCK at 13000FT, to SHAFT at 9000FT, to SNOKE, to SPINE, to SOPPY at or below 7000FT, to SNARE at 6000FT, to T6L60, to SANDY.

Critical DME	-
DME GAP	-
Inappropriate Nav aids	See AD1.1.6.10.3. Inappropriate NAVAIDs for RNAV1

Serial Number	Path Descriptor	Waypoint Identifier	Fly Over	Course °M(°T)	Magnetic Variation	Distance (NM)	Turn Direction	Altitude (FT)	Speed (KIAS)	Vertical Angle	Navigation Specification
001	IF	XAC	-	-	-7.5	-	-	-	-	-	RNAV1
002	TF	ACORN	-	068 (060.8)	-7.5	15.9	-	-	-	-	RNAV1
003	TF	SOLAR	-	026 (018.4)	-7.5	9.1	-	13000	230	-	RNAV1
004	TF	SCOUT	-	052 (044.3)	-7.5	10.1	-	-	-	-	RNAV1
005	TF	TT250	-	131 (123.1)	-7.5	9.0	-	-	-	-	RNAV1
006	TF	TT251	-	110 (102.5)	-7.5	7.1	-	-	-	-	RNAV1
007	TF	TT252	-	092 (084.3)	-7.5	7.1	-	-	-	-	RNAV1
008	TF	STOCK	-	071 (063.6)	-7.5	9.0	-	13000	230	-	RNAV1
009	TF	SHAFT	-	330 (322.4)	-7.5	22.5	-	9000	-	-	RNAV1
010	TF	SNOKE	-	011 (003.4)	-7.5	13.4	-	-	-	-	RNAV1
011	TF	SPINE	-	348 (340.6)	-7.5	6.8	-	-	-	-	RNAV1
012	TF	SOPPY	-	297 (289.2)	-7.5	8.4	-	-7000	-	-	RNAV1
013	TF	SNARE	-	297 (289.1)	-7.5	7.8	-	6000	-	-	RNAV1
014	TF	T6L60	-	297 (289.0)	-7.5	3.4	-	-	-	-	RNAV1
015	TF	SANDY	-	288 (280.0)	-7.5	3.8	-	-	-	-	RNAV1

Path	Waypoint Identifier	Inbound Course °M(°T)	Magnetic Variation	Outbound Time (MIN)	Outbound Distance (NM)	Turn Direction	Minimum Altitude (FT)	Maximum Altitude (FT)	Speed (KIAS)	Navigation Specification
Hold	XAC	098 (090.3)	-7.5	1.0(-14000) 1.5(+14001)	-	R	5000	-	-230(-14000) -240(+14001)	RNAV1
Hold	ACORN	068 (060.8)	-7.5	1.0(-14000) 1.5(+14001)	-	L	5000	-	-230(-14000) -240(+14001)	RNAV1
Hold	SHAFT	330 (322.4)	-7.5	1.0(-14000) 1.5(+14001)	-	R	4000	-	-230(-14000) -240(+14001)	RNAV1
Hold	SPINE	348 (340.6)	-7.5	1.0(-14000) 1.5(+14001)	-	L	4000	-	-230(-14000) -240(+14001)	RNAV1
Hold	SNARE	297 (289.1)	-7.5	1.0(-14000) 1.5(+14001)	-	R	4000	-	-230(-14000) -240(+14001)	RNAV1

CHANGE : New PROC



STANDARD ARRIVAL CHART-INSTRUMENT

RJTT / TOKYO INTL

RNAV STAR RWY16L/16R

OSHIMA R ARRIVAL

From XAC, to ACORN, to SOLAR, to SCOUT, to SCOPE at 10000FT, to T6R70, to NUMAN at 9000FT, to NORIK, to T6R71, to T6R72, to NURSE at 9000FT, to NEURO at 6000FT, to NIGEL at 6000FT, to NATTY.

Critical DME	-
DME GAP	-
Inappropriate NavAids	See AD1.1.6.10.3. Inappropriate NAVAIDs for RNAV1

Serial Number	Path Descriptor	Waypoint Identifier	Fly Over	Course °M(°T)	Magnetic Variation	Distance (NM)	Turn Direction	Altitude (FT)	Speed (KIAS)	Vertical Angle	Navigation Specification
001	IF	XAC	-	-	-7.5	-	-	-	-	-	RNAV1
002	TF	ACORN	-	068 (060.8)	-7.5	15.9	-	-	-	-	RNAV1
003	TF	SOLAR	-	026 (018.4)	-7.5	9.1	-	-	230	-	RNAV1
004	TF	SCOUT	-	052 (044.3)	-7.5	10.1	-	-	-	-	RNAV1
005	TF	SCOPE	-	036 (028.5)	-7.5	20.0	-	10000	-	-	RNAV1
006	TF	T6R70	-	036 (028.6)	-7.5	14.0	-	-	-	-	RNAV1
007	TF	NUMAN	-	360 (352.5)	-7.5	11.1	-	9000	210	-	RNAV1
008	TF	NORIK	-	360 (352.5)	-7.5	7.3	-	-	-	-	RNAV1
009	TF	T6R71	-	006 (358.9)	-7.5	6.5	-	-	-	-	RNAV1
010	TF	T6R72	-	342 (334.4)	-7.5	5.0	-	-	-	-	RNAV1
011	TF	NURSE	-	317 (309.8)	-7.5	6.5	-	9000	210	-	RNAV1
012	TF	NEURO	-	213 (205.5)	-7.5	13.5	-	6000	-	-	RNAV1
013	TF	NIGEL	-	252 (244.1)	-7.5	3.1	-	6000	-	-	RNAV1
014	TF	NATTY	-	252 (244.1)	-7.5	5.2	-	-	-	-	RNAV1

CHANGE : Correction of misdescription (Waypoint Identifier of the row with Serial Number 006)

Path	Waypoint Identifier	Inbound Course °M(°T)	Magnetic Variation	Outbound Time (MIN)	Outbound Distance (NM)	Turn Direction	Minimum Altitude (FT)	Maximum Altitude (FT)	Speed (KIAS)	Navigation Specification
Hold	XAC	098 (090.3)	-7.5	1.0(-14000) 1.5(+14001)	-	R	5000	-	-230(-14000) -240(+14001)	RNAV1
Hold	ACORN	068 (060.8)	-7.5	1.0(-14000) 1.5(+14001)	-	L	5000	-	-230(-14000) -240(+14001)	RNAV1
Hold	NUMAN	360 (352.5)	-7.5	1.0(-14000) 1.5(+14001)	-	L	4000	-	-230(-14000) -240(+14001)	RNAV1
Hold	NEURO	290 (282.9)	-7.5	1.0(-14000) 1.5(+14001)	-	R	4000	-	-230(-14000) -240(+14001)	RNAV1



## STANDARD ARRIVAL CHART-INSTRUMENT

RJTT / TOKYO INTL

RNAV STAR RWY16L/16R

Waypoint Coordinates

Waypoint Identifier	Coordinates	Waypoint Identifier	Coordinates
ACORN	345028.8N / 1394146.7E	SOLAR	345909.2N / 1394518.5E
NATTY	355350.9N / 1394531.3E	SOPPY	354458.8N / 1400140.3E
NEURO	355727.6N / 1395441.3E	SPINE	354213.5N / 1401125.8E
NIGEL	355607.5N / 1395117.8E	STOCK	350438.7N / 1403002.9E
NORIK	355428.9N / 1401054.5E	T6L60	354838.2N / 1394838.4E
NUMAN	354714.4N / 1401204.9E	T6R70	353614.4N / 1401351.4E
NURSE	360939.3N / 1400153.3E	T6R71	360059.5N / 1401045.1E
SANDY	354917.5N / 1394402.8E	T6R72	360530.2N / 1400804.3E
SCOPE	352358.4N / 1400538.3E	TT250	350129.7N / 1400308.5E
SCOUT	350624.1N / 1395356.8E	TT251	345957.7N / 1401136.0E
SHAFT	352227.4N / 1401313.3E	TT252	350039.9N / 1402013.0E
SNARE	354731.1N / 1395238.1E	XAC	344244.1N / 1392450.5E
SNOKE	353551.6N / 1401411.7E		

CHANGE : New PROC

STANDARD ARRIVAL CHART-INSTRUMENT

RJTT / TOKYO INTL

RNAV STAR RWY16L/16R

AKSEL L ARRIVAL  
AKSEL R ARRIVAL

RNAV 1

Note 1) DME/DME/IRU or GNSS required.  
2) RADAR service required.

VAR 8° W(2019)

MAX 230KIAS(at or below FL140)  
MAX 240KIAS(above FL140)  
1MIN(at or below FL140)  
1.5MIN(above FL140)

SNARE  
MHA 4000

MAX 230KIAS(at or below FL140)  
MAX 240KIAS(above FL140)  
1MIN(at or below FL140)  
1.5MIN(above FL140)

NUMAN  
MHA 4000

MAX 230KIAS(at or below FL140)  
MAX 240KIAS(above FL140)  
1MIN(at or below FL140)  
1.5MIN(above FL140)

SPINE  
MHA 4000

MAX 230KIAS(at or below FL140)  
MAX 240KIAS(above FL140)  
1MIN(at or below FL140)  
1.5MIN(above FL140)

NEURO  
MHA 4000

MAX 230KIAS(at or below FL140)  
MAX 240KIAS(above FL140)  
1MIN(at or below FL140)  
1.5MIN(above FL140)

SHAFT  
MHA 4000

VOR/DME  
HANEDA  
112.2 HME  
CH-59X  
35°33'44"N/139°45'40"E  
100FT

AKSEL R ARRIVAL

AKSEL L ARRIVAL

CHANGE : New PROC

MAX 230KIAS(at or below FL140)  
MAX 240KIAS(above FL140)  
1MIN(at or below FL140)  
1.5MIN(above FL140)

AKSEL  
MHA 5000

AKSEL L ARRIVAL

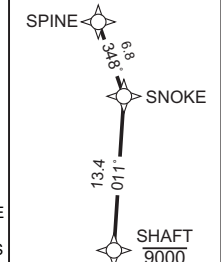

AKSEL R ARRIVAL

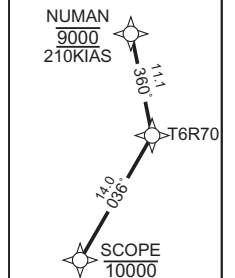

STANDARD ARRIVAL CHART-INSTRUMENT

RJTT / TOKYO INTL

RNAV STAR RWY16L/16R

AKSEL L ARRIVAL

From AKSEL, to SALLY at 12000FT, to TT253, to TT254, to TT255, to STOWE at 12000FT, to SHAFT at 9000FT, to SNOKE, to SPINE, to SOPPY at or below 7000FT, to SNARE at 6000FT, to T6L60, to SANDY.

Critical DME	-
DME GAP	-
Inappropriate Navaids	See AD1.1.6.10.3. Inappropriate NAVAIDs for RNAV1

Serial Number	Path Descriptor	Waypoint Identifier	Fly Over	Course °M(°T)	Magnetic Variation	Distance (NM)	Turn Direction	Altitude (FT)	Speed (KIAS)	Vertical Angle	Navigation Specification
001	IF	AKSEL	-	-	-7.5	-	-	-	-	-	RNAV1
002	TF	SALLY	-	023 (015.0)	-7.5	13.4	-	12000	230	-	RNAV1
003	TF	TT253	-	048 (040.5)	-7.5	8.5	-	-	-	-	RNAV1
004	TF	TT254	-	109 (102.0)	-7.5	7.6	-	-	-	-	RNAV1
005	TF	TT255	-	092 (084.4)	-7.5	7.6	-	-	-	-	RNAV1
006	TF	STOWE	-	071 (063.6)	-7.5	9.6	-	12000	230	-	RNAV1
007	TF	SHAFT	-	330 (322.4)	-7.5	24.0	-	9000	-	-	RNAV1
008	TF	SNOKE	-	011 (003.4)	-7.5	13.4	-	-	-	-	RNAV1
009	TF	SPINE	-	348 (340.6)	-7.5	6.8	-	-	-	-	RNAV1
010	TF	SOPPY	-	297 (289.2)	-7.5	8.4	-	-7000	-	-	RNAV1
011	TF	SNARE	-	297 (289.1)	-7.5	7.8	-	6000	-	-	RNAV1
012	TF	T6L60	-	297 (289.0)	-7.5	3.4	-	-	-	-	RNAV1
013	TF	SANDY	-	288 (280.0)	-7.5	3.8	-	-	-	-	RNAV1

Path	Waypoint Identifier	Inbound Course °M(°T)	Magnetic Variation	Outbound Time (MIN)	Outbound Distance (NM)	Turn Direction	Minimum Altitude (FT)	Maximum Altitude (FT)	Speed (KIAS)	Navigation Specification
Hold	AKSEL	039 (031.2)	-7.5	1.0(-14000) 1.5(+14001)	-	R	5000	-	-230(-14000) -240(+14001)	RNAV1
Hold	SHAFT	330 (322.4)	-7.5	1.0(-14000) 1.5(+14001)	-	R	4000	-	-230(-14000) -240(+14001)	RNAV1
Hold	SPINE	348 (340.6)	-7.5	1.0(-14000) 1.5(+14001)	-	L	4000	-	-230(-14000) -240(+14001)	RNAV1
Hold	SNARE	297 (289.1)	-7.5	1.0(-14000) 1.5(+14001)	-	R	4000	-	-230(-14000) -240(+14001)	RNAV1

CHANGE : New PROC

STANDARD ARRIVAL CHART-INSTRUMENT

RJTT / TOKYO INTL

RNAV STAR RWY16L/16R

AKSEL R ARRIVAL

From AKSEL, to SALLY, to SCOUT, to SCOPE at 10000FT, to T6R70, to NUMAN at 9000FT, to NORIK, to T6R71, to T6R72, to NURSE at 9000FT, to NEURO at 6000FT, to NIGEL at 6000FT, to NATTY.

Critical DME	-
DME GAP	-
Inappropriate Nav aids	See AD1.1.6.10.3. Inappropriate NAVAIDs for RNAV1

Serial Number	Path Descriptor	Waypoint Identifier	Fly Over	Course °M(T)	Magnetic Variation	Distance (NM)	Turn Direction	Altitude (FT)	Speed (KIAS)	Vertical Angle	Navigation Specification
001	IF	AKSEL	-	-	-7.5	-	-	-	-	-	RNAV1
002	TF	SALLY	-	023 (015.0)	-7.5	13.4	-	-	230	-	RNAV1
003	TF	SCOUT	-	001 (353.7)	-7.5	12.9	-	-	-	-	RNAV1
004	TF	SCOPE	-	036 (028.5)	-7.5	20.0	-	10000	-	-	RNAV1
005	TF	T6R70	-	036 (028.6)	-7.5	14.0	-	-	-	-	RNAV1
006	TF	NUMAN	-	360 (352.5)	-7.5	11.1	-	9000	210	-	RNAV1
007	TF	NORIK	-	360 (352.5)	-7.5	7.3	-	-	-	-	RNAV1
008	TF	T6R71	-	006 (358.9)	-7.5	6.5	-	-	-	-	RNAV1
009	TF	T6R72	-	342 (334.4)	-7.5	5.0	-	-	-	-	RNAV1
010	TF	NURSE	-	317 (309.8)	-7.5	6.5	-	9000	210	-	RNAV1
011	TF	NEURO	-	213 (205.5)	-7.5	13.5	-	6000	-	-	RNAV1
012	TF	NIGEL	-	252 (244.1)	-7.5	3.1	-	6000	-	-	RNAV1
013	TF	NATTY	-	252 (244.1)	-7.5	5.2	-	-	-	-	RNAV1

Path	Waypoint Identifier	Inbound Course °M(T)	Magnetic Variation	Outbound Time (MIN)	Outbound Distance (NM)	Turn Direction	Minimum Altitude (FT)	Maximum Altitude (FT)	Speed (KIAS)	Navigation Specification
Hold	AKSEL	039 (031.2)	-7.5	1.0(-14000) 1.5(+14001)	-	R	5000	-	-230(-14000) -240(+14001)	RNAV1
Hold	NUMAN	360 (352.5)	-7.5	1.0(-14000) 1.5(+14001)	-	L	4000	-	-230(-14000) -240(+14001)	RNAV1
Hold	NEURO	290 (282.9)	-7.5	1.0(-14000) 1.5(+14001)	-	R	4000	-	-230(-14000) -240(+14001)	RNAV1

CHANGE : New PROC

## STANDARD ARRIVAL CHART-INSTRUMENT

RJTT / TOKYO INTL

RNAV STAR RWY16L/16R

Waypoint Coordinates

Waypoint Identifier	Coordinates	Waypoint Identifier	Coordinates
AKSEL	344039.5N / 1395126.9E	SNARE	354731.1N / 1395238.1E
NATTY	355350.9N / 1394531.3E	SNOKE	353551.6N / 1401411.7E
NEURO	355727.6N / 1395441.3E	SOPPY	354458.8N / 1400140.3E
NIGEL	355607.5N / 1395117.8E	SPINE	354213.5N / 1401125.8E
NORIK	355428.9N / 1401054.5E	STOWE	350325.9N / 1403111.4E
NUMAN	354714.4N / 1401204.9E	T6L60	354838.2N / 1394838.4E
NURSE	360939.3N / 1400153.3E	T6R70	353614.4N / 1401351.4E
SALLY	345333.9N / 1395540.1E	T6R71	360059.5N / 1401045.1E
SANDY	354917.5N / 1394402.8E	T6R72	360530.2N / 1400804.3E
SCOPE	352358.4N / 1400538.3E	TT253	350001.4N / 1400224.6E
SCOUT	350624.1N / 1395356.8E	TT254	345826.5N / 1401129.4E
SHAFT	352227.4N / 1401313.3E	TT255	345910.9N / 1402041.4E

CHANGE : New PROC

AERODROME OBSTACLE CHART-ICAO  
TYPE A(OPERATING LIMITATIONS)

DIMENSIONS AND ELEVATIONS IN FEET BEARINGS ARE MAGNETIC

MAGNETIC VARIATION 7°W-APR 2015

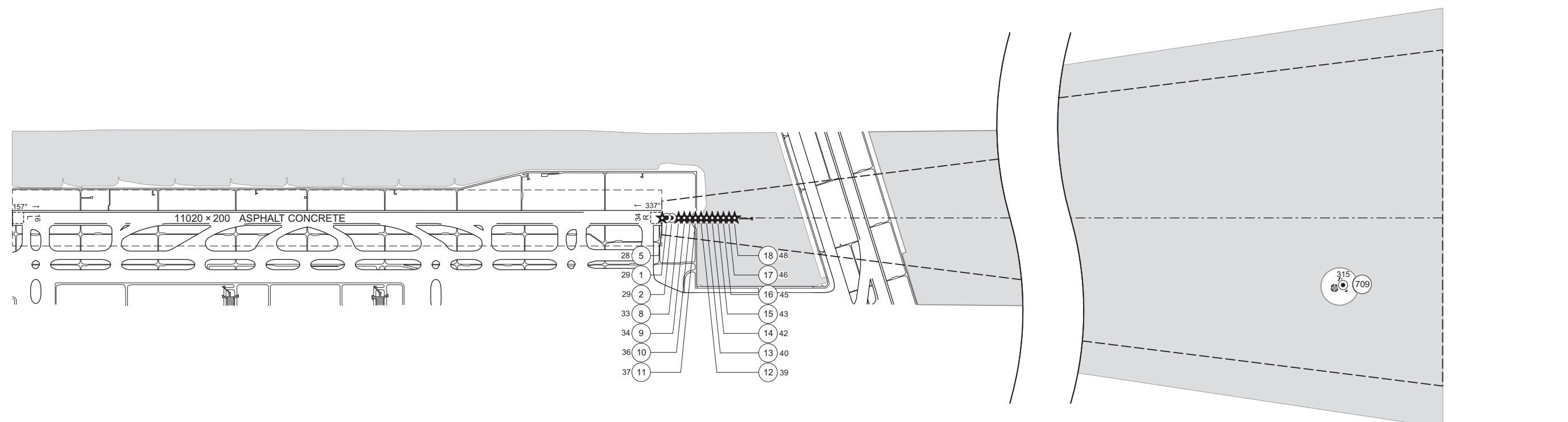
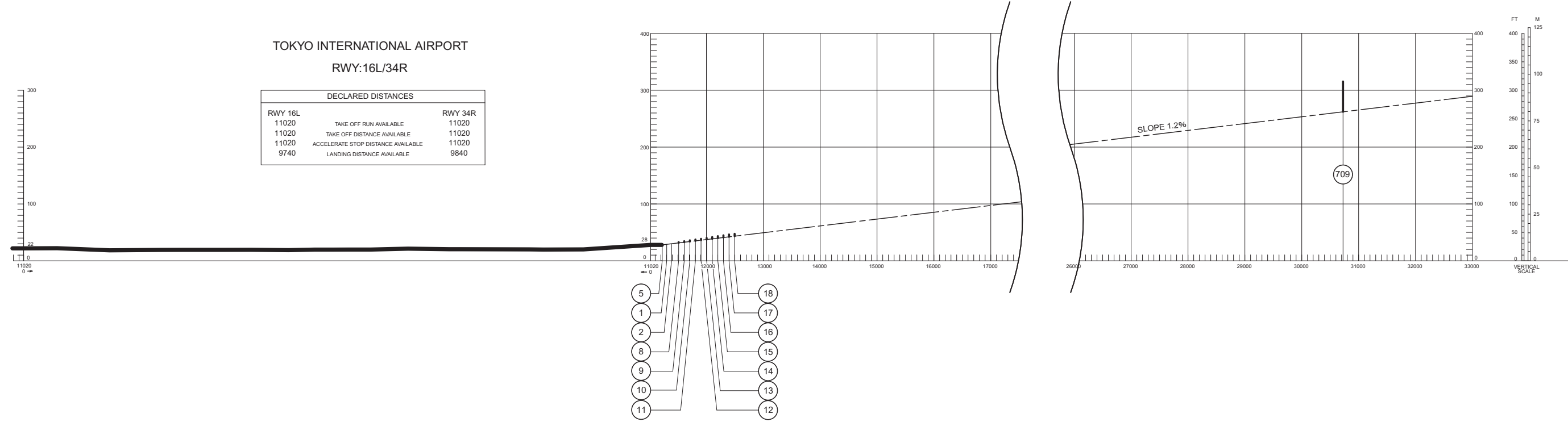

CHANGE: DECLARED DISTANCES

LEGEND		AMENDMENT RECORD		
Symbol	Description	Nr	DATE	ENTERED BY
①	IDENTIFICATION NUMBER			
⊙	POLE, TOWER, SPIRE, ANTENNA, ETC			
*	TREE			
—+—+—+—	RAILROAD			
—+—+—+—	RIVER			
—+—+—+—	TRANSMISSION LINE OR OVERHEAD CABLE			
△	TRIANGULATION POINT			
★	AERONAUTICAL GROUND LIGHT			

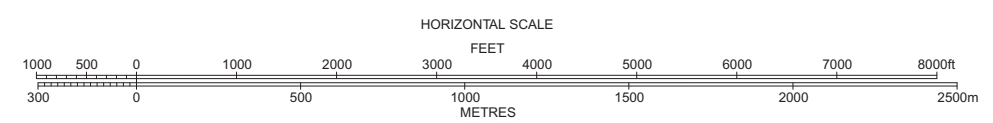

STANDARD ARRIVAL CHART-INSTRUMENT

RJTT / TOKYO INTL

RNAV STAR RWY16L/16R

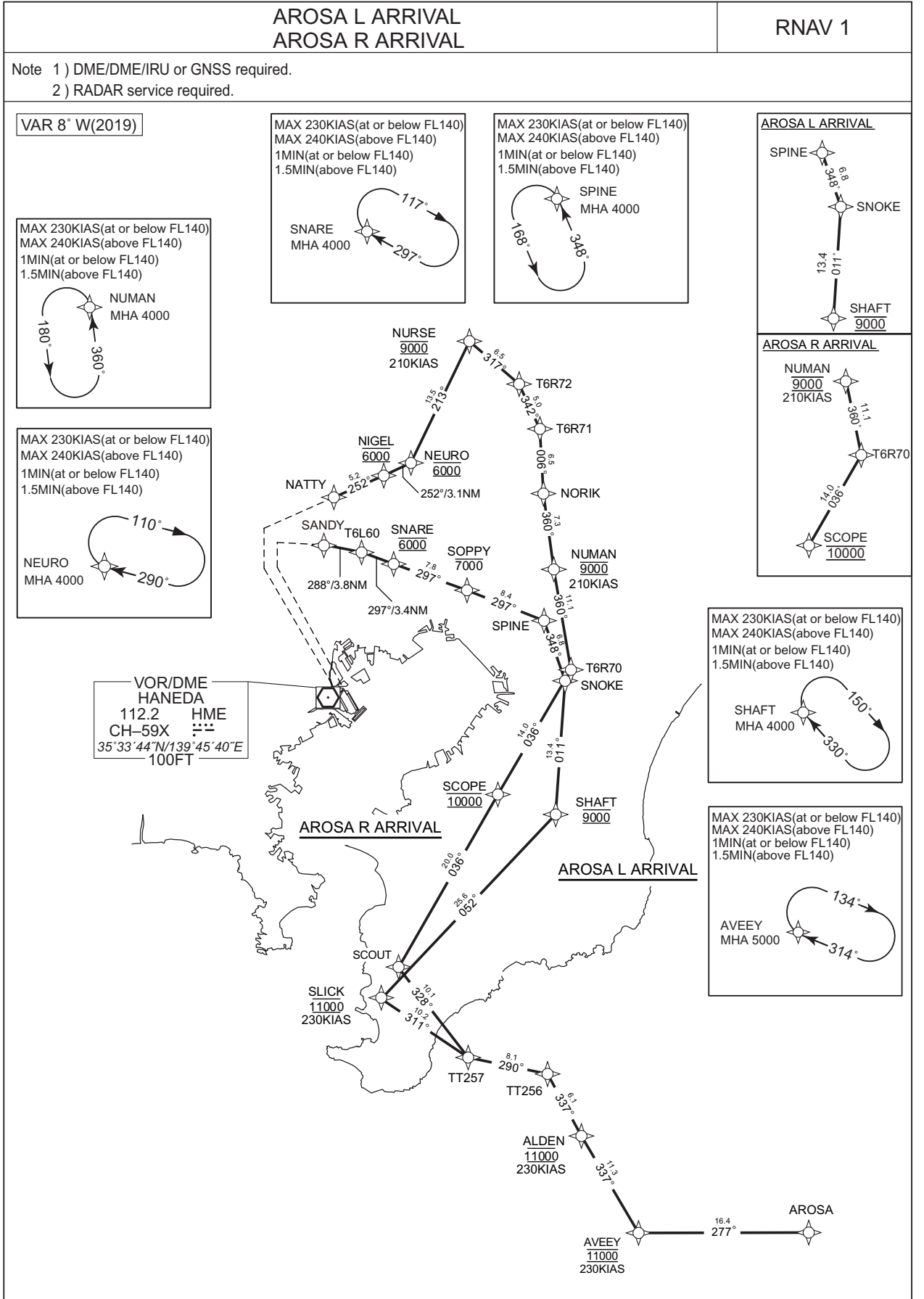

CHANGE : New PROC

STANDARD ARRIVAL CHART-INSTRUMENT

RJTT / TOKYO INTL

RNAV STAR RWY16L/16R

AROSA L ARRIVAL

From AROSA, to AVEEY at 11000FT, to ALDEN at 11000FT, to TT256, to TT257, to SLICK at 11000FT, to SHAFT at 9000FT, to SNOKE, to SPINE, to SOPPY at or below 7000FT, to SNARE at 6000FT, to T6L60, to SANDY.

Critical DME	-
DME GAP	-
Inappropriate Nav aids	See AD1.1.6.10.3. Inappropriate NAVAIDs for RNAV1

Serial Number	Path Descriptor	Waypoint Identifier	Fly Over	Course °M(°T)	Magnetic Variation	Distance (NM)	Turn Direction	Altitude (FT)	Speed (KIAS)	Vertical Angle	Navigation Specification
001	IF	AROSA	-	-	-7.5	-	-	-	-	-	RNAV1
002	TF	AVEEY	-	277 (269.8)	-7.5	16.4	-	11000	230	-	RNAV1
003	TF	ALDEN	-	337 (330.0)	-7.5	11.3	-	11000	230	-	RNAV1
004	TF	TT256	-	337 (329.9)	-7.5	6.1	-	-	-	-	RNAV1
005	TF	TT257	-	290 (282.4)	-7.5	8.1	-	-	-	-	RNAV1
006	TF	SLICK	-	311 (303.1)	-7.5	10.2	-	11000	230	-	RNAV1
007	TF	SHAFT	-	052 (044.3)	-7.5	25.6	-	9000	-	-	RNAV1
008	TF	SNOKE	-	011 (003.4)	-7.5	13.4	-	-	-	-	RNAV1
009	TF	SPINE	-	348 (340.6)	-7.5	6.8	-	-	-	-	RNAV1
010	TF	SOPPY	-	297 (289.2)	-7.5	8.4	-	-7000	-	-	RNAV1
011	TF	SNARE	-	297 (289.1)	-7.5	7.8	-	6000	-	-	RNAV1
012	TF	T6L60	-	297 (289.0)	-7.5	3.4	-	-	-	-	RNAV1
013	TF	SANDY	-	288 (280.0)	-7.5	3.8	-	-	-	-	RNAV1

Path	Waypoint Identifier	Inbound Course °M(°T)	Magnetic Variation	Outbound Time (MIN)	Outbound Distance (NM)	Turn Direction	Minimum Altitude (FT)	Maximum Altitude (FT)	Speed (KIAS)	Navigation Specification
Hold	AVEEY	314 (306.1)	-7.5	1.0(-14000) 1.5(+14001)	-	R	5000	-	-230(-14000) -240(+14001)	RNAV1
Hold	SHAFT	330 (322.4)	-7.5	1.0(-14000) 1.5(+14001)	-	R	4000	-	-230(-14000) -240(+14001)	RNAV1
Hold	SPINE	348 (340.6)	-7.5	1.0(-14000) 1.5(+14001)	-	L	4000	-	-230(-14000) -240(+14001)	RNAV1
Hold	SNARE	297 (289.1)	-7.5	1.0(-14000) 1.5(+14001)	-	R	4000	-	-230(-14000) -240(+14001)	RNAV1

CHANGE : New PROC



STANDARD ARRIVAL CHART-INSTRUMENT

RJTT / TOKYO INTL

RNAV STAR RWY16L/16R

AROSA R ARRIVAL

From AROSA, to AVEEY at 11000FT, to ALDEN at 11000FT, to TT256, to TT257, to SCOUT, to SCOPE at 10000FT, to T6R70, to NUMAN at 9000FT, to NORIK, to T6R71, to T6R72, to NURSE at 9000FT, to NEURO at 6000FT, to NIGEL at 6000FT, to NATTY.

Critical DME	-
DME GAP	-
Inappropriate Navaids	See AD1.1.6.10.3. Inappropriate NAVAIDs for RNAV1

Serial Number	Path Descriptor	Waypoint Identifier	Fly Over	Course °M(°T)	Magnetic Variation	Distance (NM)	Turn Direction	Altitude (FT)	Speed (KIAS)	Vertical Angle	Navigation Specification
001	IF	AROSA	-	-	-7.5	-	-	-	-	-	RNAV1
002	TF	AVEEY	-	277 (269.8)	-7.5	16.4	-	11000	230	-	RNAV1
003	TF	ALDEN	-	337 (330.0)	-7.5	11.3	-	11000	230	-	RNAV1
004	TF	TT256	-	337 (329.9)	-7.5	6.1	-	-	-	-	RNAV1
005	TF	TT257	-	290 (282.4)	-7.5	8.1	-	-	-	-	RNAV1
006	TF	SCOUT	-	328 (320.5)	-7.5	10.1	-	-	-	-	RNAV1
007	TF	SCOPE	-	036 (028.5)	-7.5	20.0	-	10000	-	-	RNAV1
008	TF	T6R70	-	036 (028.6)	-7.5	14.0	-	-	-	-	RNAV1
009	TF	NUMAN	-	360 (352.5)	-7.5	11.1	-	9000	210	-	RNAV1
010	TF	NORIK	-	360 (352.5)	-7.5	7.3	-	-	-	-	RNAV1
011	TF	T6R71	-	006 (358.9)	-7.5	6.5	-	-	-	-	RNAV1
012	TF	T6R72	-	342 (334.4)	-7.5	5.0	-	-	-	-	RNAV1
013	TF	NURSE	-	317 (309.8)	-7.5	6.5	-	9000	210	-	RNAV1
014	TF	NEURO	-	213 (205.5)	-7.5	13.5	-	6000	-	-	RNAV1
015	TF	NIGEL	-	252 (244.1)	-7.5	3.1	-	6000	-	-	RNAV1
016	TF	NATTY	-	252 (244.1)	-7.5	5.2	-	-	-	-	RNAV1

Path	Waypoint Identifier	Inbound Course °M(°T)	Magnetic Variation	Outbound Time (MIN)	Outbound Distance (NM)	Turn Direction	Minimum Altitude (FT)	Maximum Altitude (FT)	Speed (KIAS)	Navigation Specification
Hold	AVEEY	314 (306.1)	-7.5	1.0(-14000) 1.5(+14001)	-	R	5000	-	-230(-14000) -240(+14001)	RNAV1
Hold	NUMAN	360 (352.5)	-7.5	1.0(-14000) 1.5(+14001)	-	L	4000	-	-230(-14000) -240(+14001)	RNAV1
Hold	NEURO	290 (282.9)	-7.5	1.0(-14000) 1.5(+14001)	-	R	4000	-	-230(-14000) -240(+14001)	RNAV1

CHANGE : New PROC

## STANDARD ARRIVAL CHART-INSTRUMENT

RJTT / TOKYO INTL

RNAV STAR RWY16L/16R

Waypoint Coordinates

Waypoint Identifier	Coordinates	Waypoint Identifier	Coordinates
ALDEN	345141.1N / 1401505.3E	SHAFT	352227.4N / 1401313.3E
AROSA	344201.7N / 1404157.3E	SLICK	350412.7N / 1395120.0E
AVEEY	344155.9N / 1402158.0E	SNARE	354731.1N / 1395238.1E
NATTY	355350.9N / 1394531.3E	SNOKE	353551.6N / 1401411.7E
NEURO	355727.6N / 1395441.3E	SOPPY	354458.8N / 1400140.3E
NIGEL	355607.5N / 1395117.8E	SPINE	354213.5N / 1401125.8E
NORIK	355428.9N / 1401054.5E	T6L60	354838.2N / 1394838.4E
NUMAN	354714.4N / 1401204.9E	T6R70	353614.4N / 1401351.4E
NURSE	360939.3N / 1400153.3E	T6R71	360059.5N / 1401045.1E
SANDY	354917.5N / 1394402.8E	T6R72	360530.2N / 1400804.3E
SCOPE	352358.4N / 1400538.3E	TT256	345655.4N / 1401122.9E
SCOUT	350624.1N / 1395356.8E	TT257	345838.5N / 1400146.6E

CHANGE : New PROC

STANDARD ARRIVAL CHART-INSTRUMENT

RJTT / TOKYO INTL

RNAV STAR RWY16L/16R

GODIN L ARRIVAL  
GODIN R ARRIVAL

RNAV 1

Note 1 ) DME/DME/IRU or GNSS required.  
2 ) RADAR service required.

VAR 8° W(2019)

MAX 230KIAS(at or below FL140)  
MAX 240KIAS(above FL140)  
1MIN(at or below FL140)  
1.5MIN(above FL140)

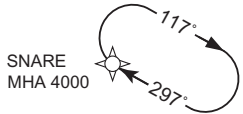

MAX 230KIAS(at or below FL140)  
MAX 240KIAS(above FL140)  
1MIN(at or below FL140)  
1.5MIN(above FL140)

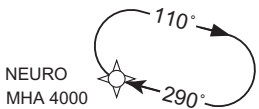

MAX 230KIAS(at or below FL140)  
MAX 240KIAS(above FL140)  
1MIN(at or below FL140)  
1.5MIN(above FL140)

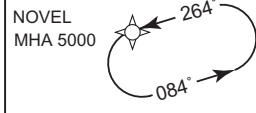

MAX 230KIAS(at or below FL140)  
MAX 240KIAS(above FL140)  
1MIN(at or below FL140)  
1.5MIN(above FL140)

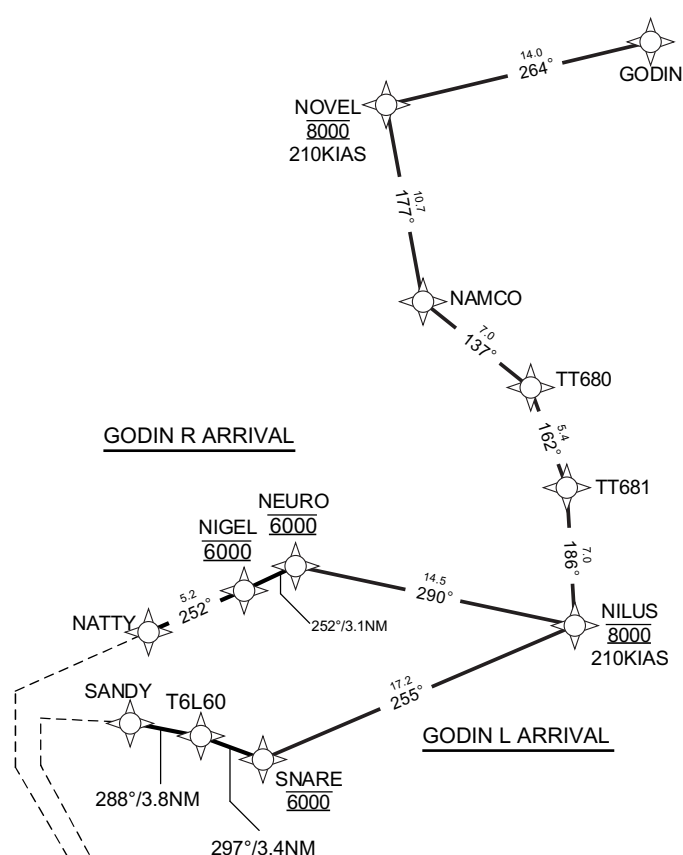

VOR/DME  
HANEDA  
112.2 HME  
CH-59X  
35°33'44"N/139°45'40"E  
100FT

CHANGE : New PROC

STANDARD ARRIVAL CHART-INSTRUMENT

RJTT / TOKYO INTL

RNAV STAR RWY16L/16R

GODIN L ARRIVAL

From GODIN, to NOVEL at 8000FT, to NAMCO, to TT680, to TT681, to NILUS at 8000FT, to SNARE at 6000FT, to T6L60, to SANDY.

Critical DME	-
DME GAP	-
Inappropriate Nav aids	See AD1.1.6.10.3. Inappropriate NAVAIDs for RNAV1

Serial Number	Path Descriptor	Waypoint Identifier	Fly Over	Course °M(°T)	Magnetic Variation	Distance (NM)	Turn Direction	Altitude (FT)	Speed (KIAS)	Vertical Angle	Navigation Specification
001	IF	GODIN	-	-	-7.5	-	-	-	-	-	RNAV1
002	TF	NOVEL	-	264 (256.4)	-7.5	14.0	-	8000	210	-	RNAV1
003	TF	NAMCO	-	177 (169.8)	-7.5	10.7	-	-	-	-	RNAV1
004	TF	TT680	-	137 (129.7)	-7.5	7.0	-	-	-	-	RNAV1
005	TF	TT681	-	162 (154.3)	-7.5	5.4	-	-	-	-	RNAV1
006	TF	NILUS	-	186 (178.9)	-7.5	7.0	-	8000	210	-	RNAV1
007	TF	SNARE	-	255 (247.0)	-7.5	17.2	-	6000	-	-	RNAV1
008	TF	T6L60	-	297 (289.0)	-7.5	3.4	-	-	-	-	RNAV1
009	TF	SANDY	-	288 (280.0)	-7.5	3.8	-	-	-	-	RNAV1

Path	Waypoint Identifier	Inbound Course °M(°T)	Magnetic Variation	Outbound Time (MIN)	Outbound Distance (NM)	Turn Direction	Minimum Altitude (FT)	Maximum Altitude (FT)	Speed (KIAS)	Navigation Specification
Hold	GODIN	197 (189.2)	-7.5	1.0(-14000) 1.5(+14001)	-	R	8000	-	-230(-14000) -240(+14001)	RNAV1
Hold	NOVEL	264 (256.4)	-7.5	1.0(-14000) 1.5(+14001)	-	L	5000	-	-230(-14000) -240(+14001)	RNAV1
Hold	SNARE	297 (289.1)	-7.5	1.0(-14000) 1.5(+14001)	-	R	4000	-	-230(-14000) -240(+14001)	RNAV1

CHANGE : New PROC

STANDARD ARRIVAL CHART-INSTRUMENT

RJTT / TOKYO INTL

RNAV STAR RWY16L/16R

GODIN R ARRIVAL

From GODIN, to NOVEL at 8000FT, to NAMCO, to TT680, to TT681, to NILUS at 8000FT, to NEURO at 6000FT, to NIGEL at 6000FT, to NATTY.

Critical DME	-
DME GAP	-
Inappropriate Nav aids	See AD1.1.6.10.3. Inappropriate NAVAIDs for RNAV1

Serial Number	Path Descriptor	Waypoint Identifier	Fly Over	Course °M(°T)	Magnetic Variation	Distance (NM)	Turn Direction	Altitude (FT)	Speed (KIAS)	Vertical Angle	Navigation Specification
001	IF	GODIN	-	-	-7.5	-	-	-	-	-	RNAV1
002	TF	NOVEL	-	264 (256.4)	-7.5	14.0	-	8000	210	-	RNAV1
003	TF	NAMCO	-	177 (169.8)	-7.5	10.7	-	-	-	-	RNAV1
004	TF	TT680	-	137 (129.7)	-7.5	7.0	-	-	-	-	RNAV1
005	TF	TT681	-	162 (154.3)	-7.5	5.4	-	-	-	-	RNAV1
006	TF	NILUS	-	186 (178.9)	-7.5	7.0	-	8000	210	-	RNAV1
007	TF	NEURO	-	290 (282.9)	-7.5	14.5	-	6000	-	-	RNAV1
008	TF	NIGEL	-	252 (244.1)	-7.5	3.1	-	6000	-	-	RNAV1
009	TF	NATTY	-	252 (244.1)	-7.5	5.2	-	-	-	-	RNAV1

Path	Waypoint Identifier	Inbound Course °M(°T)	Magnetic Variation	Outbound Time (MIN)	Outbound Distance (NM)	Turn Direction	Minimum Altitude (FT)	Maximum Altitude (FT)	Speed (KIAS)	Navigation Specification
Hold	GODIN	197 (189.2)	-7.5	1.0(-14000) 1.5(+14001)	-	R	8000	-	-230(-14000) -240(+14001)	RNAV1
Hold	NOVEL	264 (256.4)	-7.5	1.0(-14000) 1.5(+14001)	-	L	5000	-	-230(-14000) -240(+14001)	RNAV1
Hold	NEURO	290 (282.9)	-7.5	1.0(-14000) 1.5(+14001)	-	R	4000	-	-230(-14000) -240(+14001)	RNAV1

CHANGE : New PROC

STANDARD ARRIVAL CHART-INSTRUMENT

RJTT / TOKYO INTL

RNAV STAR RWY16L/16R

Waypoint Coordinates

Waypoint Identifier	Coordinates	Waypoint Identifier	Coordinates
GODIN	362425.3N / 1401655.9E	NOVEL	362106.9N / 1400004.9E
NAMCO	361035.1N / 1400226.3E	SANDY	354917.5N / 1394402.8E
NATTY	355350.9N / 1394531.3E	SNARE	354731.1N / 1395238.1E
NEURO	355727.6N / 1395441.3E	T6L60	354838.2N / 1394838.4E
NIGEL	355607.5N / 1395117.8E	TT680	360608.2N / 1400904.0E
NILUS	355415.2N / 1401208.8E	TT681	360113.8N / 1401158.7E

CHANGE : New PROC

STANDARD ARRIVAL CHART-INSTRUMENT

RJTT / TOKYO INTL

RNAV STAR RWY16L/16R

POLIX L ARRIVAL  
POLIX R ARRIVAL

RNAV 1

Note 1) DME/DME/IRU or GNSS required.  
2) RADAR service required.

VAR 8° W(2019)

MAX 230KIAS(at or below FL140)  
MAX 240KIAS(above FL140)  
1MIN(at or below FL140)  
1.5MIN(above FL140)



MAX 230KIAS(at or below FL140)  
MAX 240KIAS(above FL140)  
1MIN(at or below FL140)  
1.5MIN(above FL140)

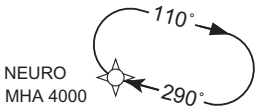

MAX 230KIAS(at or below FL140)  
MAX 240KIAS(above FL140)  
1MIN(at or below FL140)  
1.5MIN(above FL140)

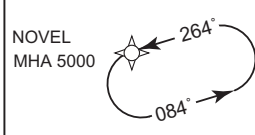

MAX 230KIAS(at or below FL140)  
MAX 240KIAS(above FL140)  
1MIN(at or below FL140)  
1.5MIN(above FL140)



MAX 230KIAS(at or below FL140)  
MAX 240KIAS(above FL140)  
1MIN(at or below FL140)  
1.5MIN(above FL140)

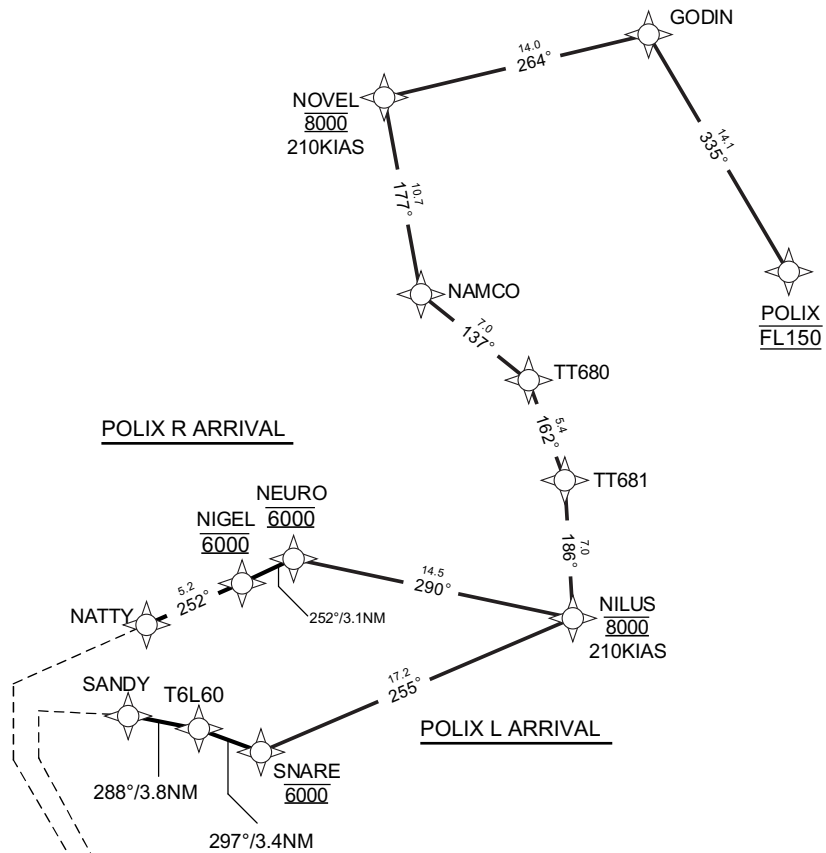
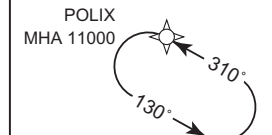

VOR/DME  
HANEDA  
112.2 HME  
CH-59X  
35°33'44"N/139°45'40"E  
100FT

CHANGE : New PROC

STANDARD ARRIVAL CHART-INSTRUMENT

RJTT / TOKYO INTL

RNAV STAR RWY16L/16R

POLIX L ARRIVAL

From POLIX at FL150, to GODIN, to NOVEL at 8000FT, to NAMCO, to TT680, to TT681, to NILUS at 8000FT, to SNARE at 6000FT, to T6L60, to SANDY.

Critical DME	-
DME GAP	-
Inappropriate Nav aids	See AD1.1.6.10.3. Inappropriate NAVAIDs for RNAV1

Serial Number	Path Descriptor	Waypoint Identifier	Fly Over	Course °M(°T)	Magnetic Variation	Distance (NM)	Turn Direction	Altitude (FT)	Speed (KIAS)	Vertical Angle	Navigation Specification
001	IF	POLIX	-	-	-7.5	-	-	FL150	-	-	RNAV1
002	TF	GODIN	-	335 (327.2)	-7.5	14.1	-	-	-	-	RNAV1
003	TF	NOVEL	-	264 (256.4)	-7.5	14.0	-	8000	210	-	RNAV1
004	TF	NAMCO	-	177 (169.8)	-7.5	10.7	-	-	-	-	RNAV1
005	TF	TT680	-	137 (129.7)	-7.5	7.0	-	-	-	-	RNAV1
006	TF	TT681	-	162 (154.3)	-7.5	5.4	-	-	-	-	RNAV1
007	TF	NILUS	-	186 (178.9)	-7.5	7.0	-	8000	210	-	RNAV1
008	TF	SNARE	-	255 (247.0)	-7.5	17.2	-	6000	-	-	RNAV1
009	TF	T6L60	-	297 (289.0)	-7.5	3.4	-	-	-	-	RNAV1
010	TF	SANDY	-	288 (280.0)	-7.5	3.8	-	-	-	-	RNAV1

Path	Waypoint Identifier	Inbound Course °M(°T)	Magnetic Variation	Outbound Time (MIN)	Outbound Distance (NM)	Turn Direction	Minimum Altitude (FT)	Maximum Altitude (FT)	Speed (KIAS)	Navigation Specification
Hold	POLIX	310 (302.3)	-7.5	1.0(-14000) 1.5(+14001)	-	L	11000	-	-230(-14000) -240(+14001)	RNAV1
Hold	GODIN	197 (189.2)	-7.5	1.0(-14000) 1.5(+14001)	-	R	8000	-	-230(-14000) -240(+14001)	RNAV1
Hold	NOVEL	264 (256.4)	-7.5	1.0(-14000) 1.5(+14001)	-	L	5000	-	-230(-14000) -240(+14001)	RNAV1
Hold	SNARE	297 (289.1)	-7.5	1.0(-14000) 1.5(+14001)	-	R	4000	-	-230(-14000) -240(+14001)	RNAV1

CHANGE : New PROC



STANDARD ARRIVAL CHART-INSTRUMENT

RJTT / TOKYO INTL

RNAV STAR RWY16L/16R

POLIX R ARRIVAL

From POLIX at FL150, to GODIN, to NOVEL at 8000FT, to NAMCO, to TT680, to TT681, to NILUS at 8000FT, to NEURO at 6000FT, to NIGEL at 6000FT, to NATTY.

Critical DME	-
DME GAP	-
Inappropriate Navaids	See AD1.1.6.10.3. Inappropriate NAVAIDs for RNAV1

Serial Number	Path Descriptor	Waypoint Identifier	Fly Over	Course °M(°T)	Magnetic Variation	Distance (NM)	Turn Direction	Altitude (FT)	Speed (KIAS)	Vertical Angle	Navigation Specification
001	IF	POLIX	-	-	-7.5	-	-	FL150	-	-	RNAV1
002	TF	GODIN	-	335 (327.2)	-7.5	14.1	-	-	-	-	RNAV1
003	TF	NOVEL	-	264 (256.4)	-7.5	14.0	-	8000	210	-	RNAV1
004	TF	NAMCO	-	177 (169.8)	-7.5	10.7	-	-	-	-	RNAV1
005	TF	TT680	-	137 (129.7)	-7.5	7.0	-	-	-	-	RNAV1
006	TF	TT681	-	162 (154.3)	-7.5	5.4	-	-	-	-	RNAV1
007	TF	NILUS	-	186 (178.9)	-7.5	7.0	-	8000	210	-	RNAV1
008	TF	NEURO	-	290 (282.9)	-7.5	14.5	-	6000	-	-	RNAV1
009	TF	NIGEL	-	252 (244.1)	-7.5	3.1	-	6000	-	-	RNAV1
010	TF	NATTY	-	252 (244.1)	-7.5	5.2	-	-	-	-	RNAV1

Path	Waypoint Identifier	Inbound Course °M(°T)	Magnetic Variation	Outbound Time (MIN)	Outbound Distance (NM)	Turn Direction	Minimum Altitude (FT)	Maximum Altitude (FT)	Speed (KIAS)	Navigation Specification
Hold	POLIX	310 (302.3)	-7.5	1.0(-14000) 1.5(+14001)	-	L	11000	-	-230(-14000) -240(+14001)	RNAV1
Hold	GODIN	197 (189.2)	-7.5	1.0(-14000) 1.5(+14001)	-	R	8000	-	-230(-14000) -240(+14001)	RNAV1
Hold	NOVEL	264 (256.4)	-7.5	1.0(-14000) 1.5(+14001)	-	L	5000	-	-230(-14000) -240(+14001)	RNAV1
Hold	NEURO	290 (282.9)	-7.5	1.0(-14000) 1.5(+14001)	-	R	4000	-	-230(-14000) -240(+14001)	RNAV1

CHANGE : New PROC

STANDARD ARRIVAL CHART-INSTRUMENT

RJTT / TOKYO INTL

RNAV STAR RWY16L/16R

Waypoint Coordinates

Waypoint Identifier	Coordinates	Waypoint Identifier	Coordinates
GODIN	362425.3N / 1401655.9E	POLIX	361237.1N / 1402622.5E
NAMCO	361035.1N / 1400226.3E	SANDY	354917.5N / 1394402.8E
NATTY	355350.9N / 1394531.3E	SNARE	354731.1N / 1395238.1E
NEURO	355727.6N / 1395441.3E	T6L60	354838.2N / 1394838.4E
NIGEL	355607.5N / 1395117.8E	TT680	360608.2N / 1400904.0E
NILUS	355415.2N / 1401208.8E	TT681	360113.8N / 1401158.7E
NOVEL	362106.9N / 1400004.9E		

CHANGE : New PROC

INSTRUMENT APPROACH CHART

RJTT / TOKYO INTL

ILS or LOC RWY16R

TOKYO APP 119.1 - 119.4 - 119.7 126.5 - 236.8 - 261.2	ILS - LOC 111.55 ITA ILS-GP 332.75 ILS-DME CH-52Y	TOKYO TOWER 118.1 - 124.35 - 118.575 118.725 - 118.8	RADAR AVBL ATIS 128.8
---	--	--	--------------------------

Simultaneous approach authorized with RWY 16L(ILS)

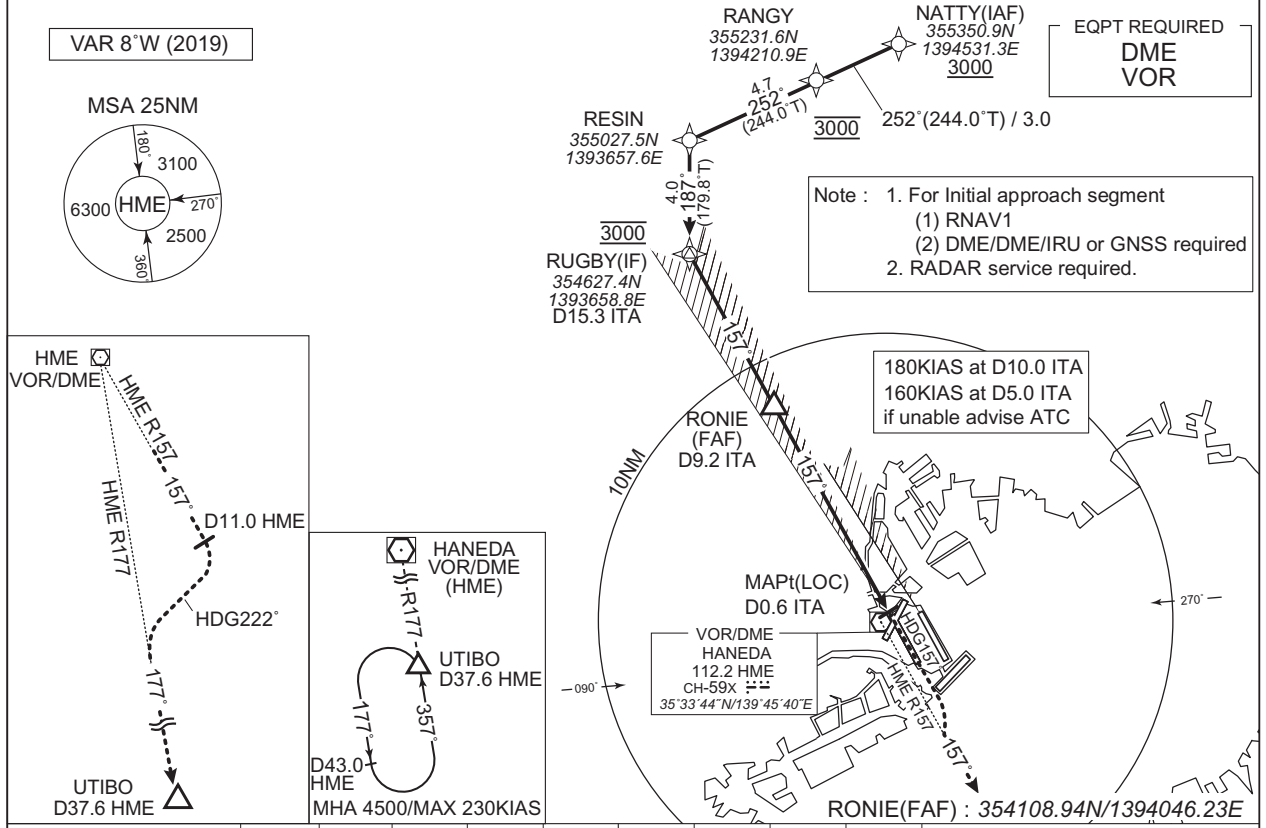

NM to Next ITA	FAF	9	8	7	6	5	4	3	MAPt
ALT (3.0° APCH Path)	2924	2873	2554	2236	1918	1599	1281	962	-

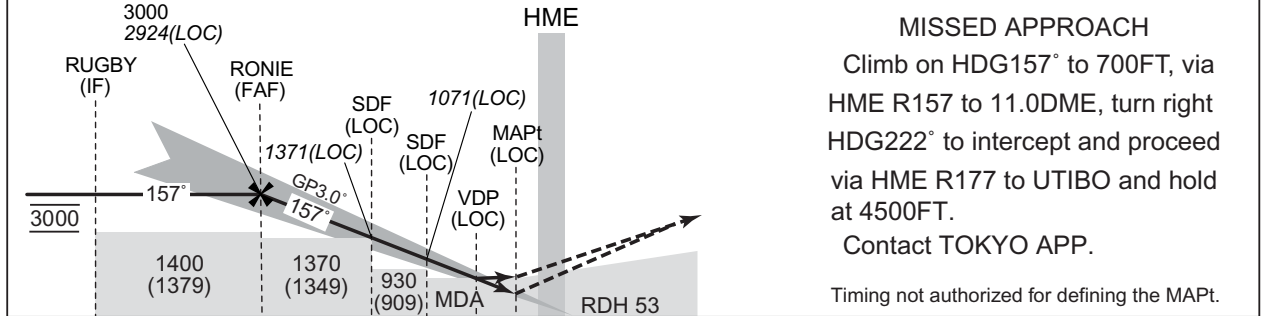

15.3	9.2	4.3	3.3	1.9	0.6	0.2	DME to ITA
15.1	9.0	4.1	3.2	1.7	0.5	0	NM to THR

Missed APCH climb gradient MNM 5.0%

MINIMA		THR elev. 16		AD elev. 21		
CAT	CAT I		LOC		CIRCLING	
	DA(H)	RVR/CMV	MDA(H)	RVR/CMV	MDA(H)	VIS
A	216 (200)	550	570 (549)	1000	730 (709)	1600
B				1200		2400
C				1600		3200
D						

MINIMA with Missed APCH climb gradient of 2.5% are not established.  
Circling is not authorized during the night time, except clockwise circling to RWY16L/22/23/34R/34L.

CHANGE : New PROC

INSTRUMENT APPROACH CHART

RJTT / TOKYO INTL

RNAV (GNSS) RWY16R

TOKYO APP 119.1 - 119.4 - 119.7 126.5 - 236.8 - 261.2	1 DME/DME not authorized. 2 RADAR service required. 3 GNSS required.	TOKYO TOWER 118.1 - 124.35 - 118.575 118.725 - 118.8	RADAR AVBL ATIS 128.8
---	--	--	--------------------------

Simultaneous approach authorized with RWY 16L(RNAV)

Baro-VNAV not authorized below -10°C

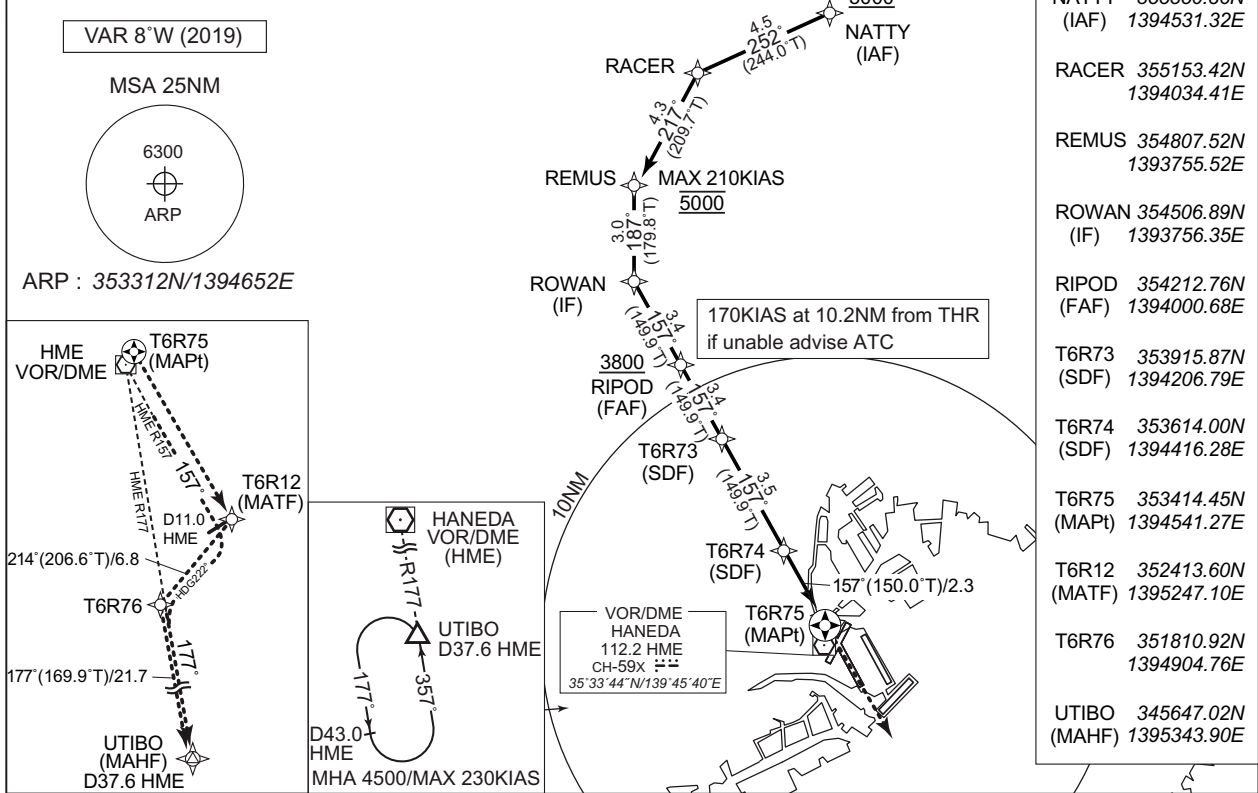

NM to Next FIX	FAF	9	8	7	6	5	4	3	2	1	MAPt
ALT (3.45° APCH Path)	3800	3734	3367	3001	2635	2268	1902	1536	1169	803	-

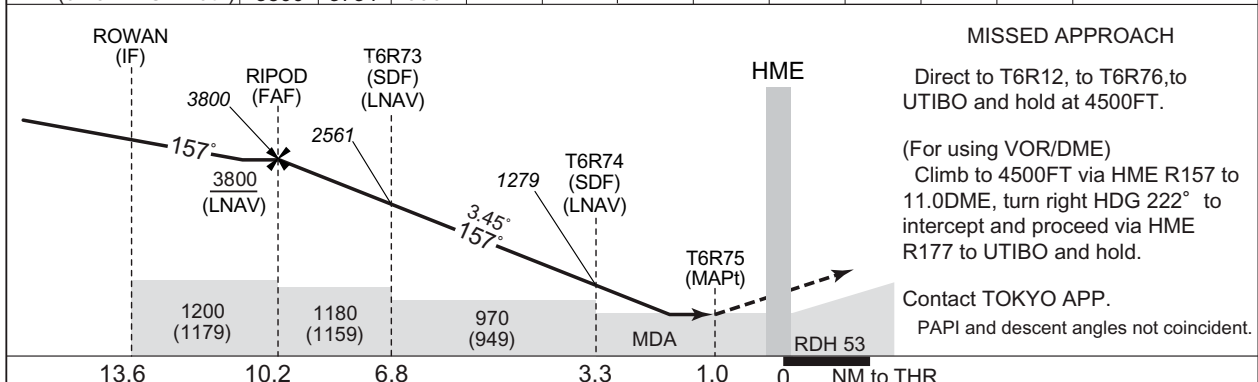

Missed APCH climb gradient MNM 5.0%

MINIMA		THR elev. 16		AD elev. 21		
CAT	LNAV/VNAV		LNAV		CIRCLING	
	DA(H)	RVR/CMV	MDA(H)	RVR/CMV	MDA(H)	VIS
A	570 (554)	1000	570 (549)	1000	730 (709)	1600
B		1200		1200		
C		1600		1600		2400
D				1600		3200

MINIMA with Missed APCH climb gradient of 2.5% are not established.  
Circling is not authorized during the night time, except clockwise circling to RWY16L/22/23/34R/34L.

CHANGE: New PROC

INSTRUMENT APPROACH CHART

RJTT / TOKYO INTL

ILS or LOC RWY16L

TOKYO APP 119.1 - 119.4 - 119.7 126.5 - 236.8 - 261.2	ILS - LOC 111.95 IOC ILS-GP 330.95 ILS-DME CH-56Y	TOKYO TOWER 124.35 - 118.1 - 118.575 118.725 - 118.8	RADAR AVBL ATIS 128.8
---	--	--	--------------------------

Simultaneous approach authorized with RWY 16R(ILS)

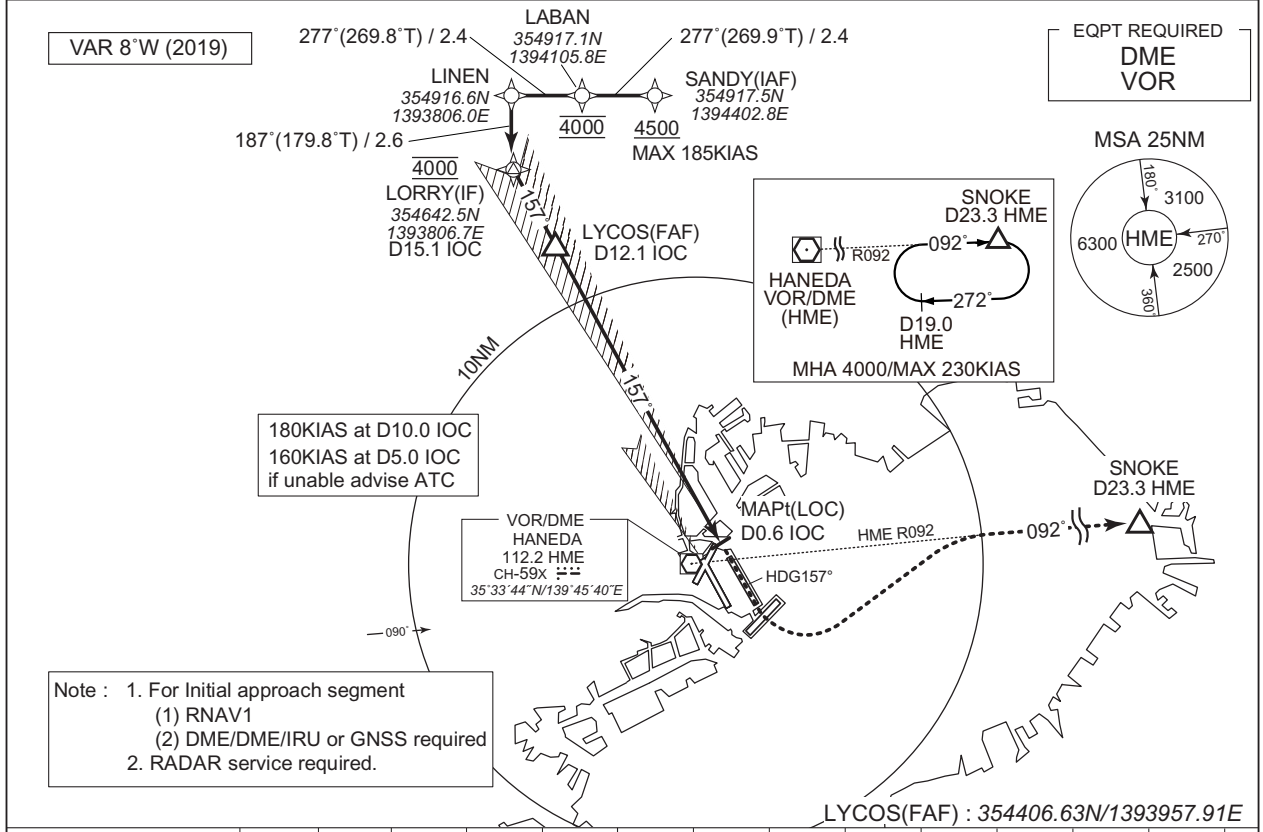

NM to IOC	FAF	12	11	10	9	8	7	6	5	4	3	2	MAPt
ALT (3.0° APCH Path)	3869	3833	3515	3197	2878	2560	2241	1923	1604	1286	967	649	-

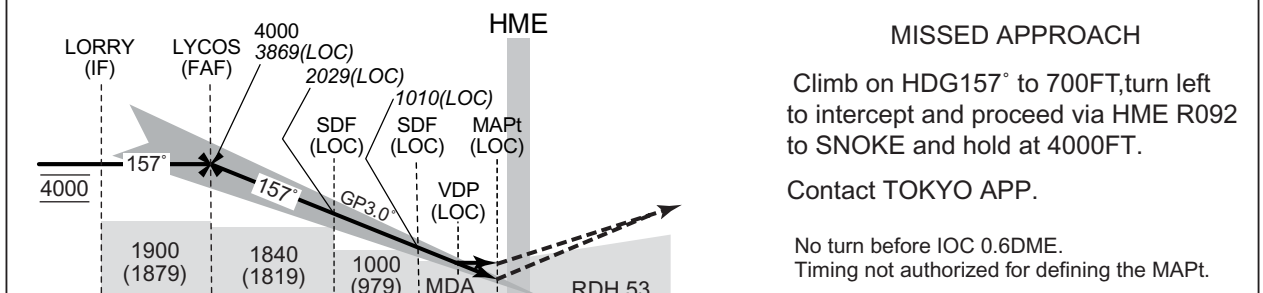

15.1	12.1	6.3	3.1	1.7	0.6	0.2	DME to IOC
15.0	12.0	6.2	3.0	1.5	0.5	0	NM to THR

Missed APCH climb gradient MNM 5.0%

MINIMA		THR elev. 19		AD elev. 21			
CAT	CAT I		LOC		CIRCLING		
	DA(H)	RVR/CMV	MDA(H)	RVR/CMV	MDA(H)	VIS	
	A	219 (200)	550	530 (509)	1000	730 (709)	1600
					1200		
B	219 (200)	550	530 (509)	1600	730 (709)	2400	
C				3200			
D							

MINIMA with Missed APCH climb gradient of 2.5% are not established.  
Circling is not authorized during the night time, except counterclockwise circling to RWY16R, clockwise circling to 22/23/34R/34L.

INSTRUMENT APPROACH CHART

RJTT / TOKYO INTL

RNAV (GNSS) RWY16L

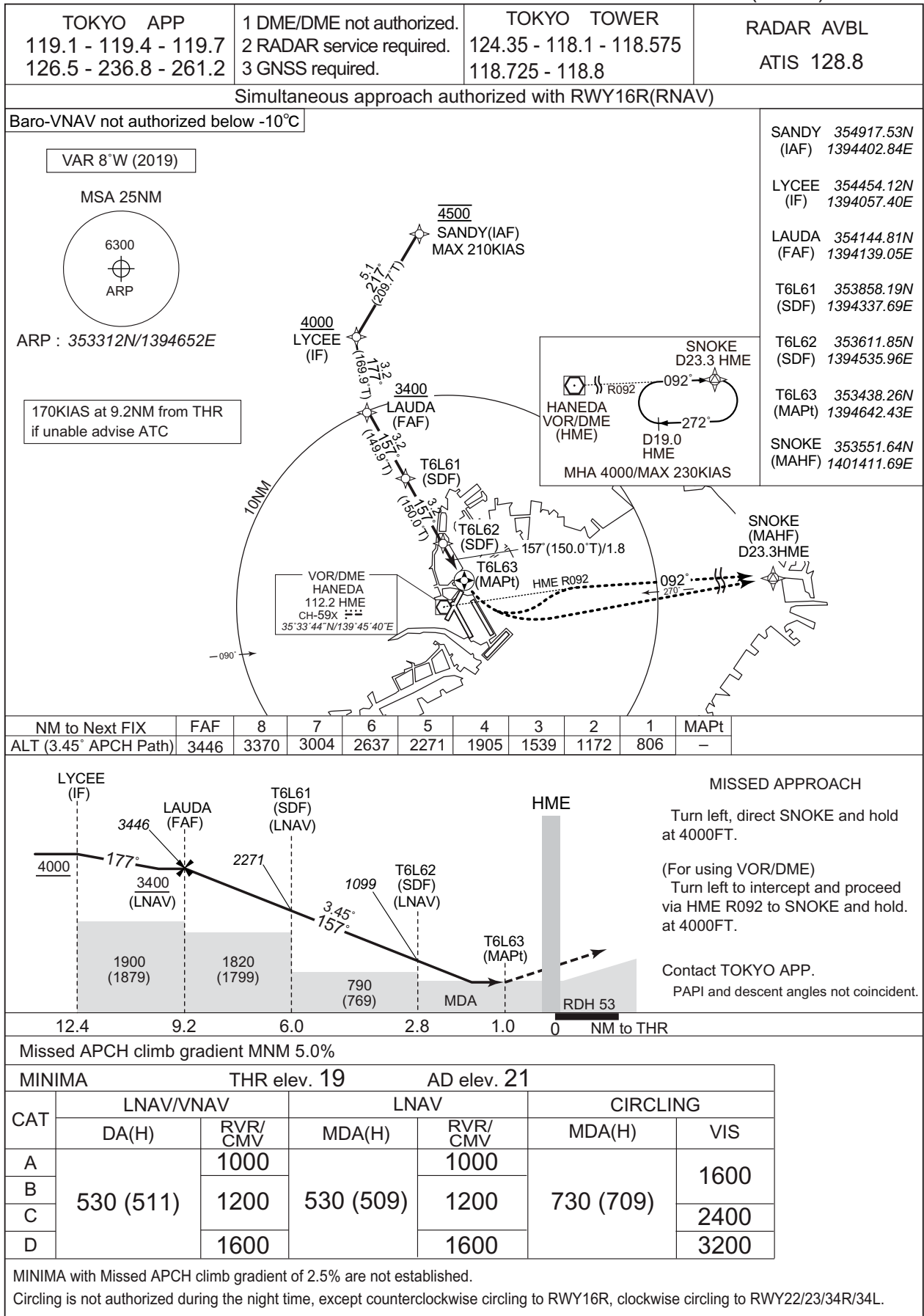

CHANGE : New PROC

AERODROME OBSTACLE CHART-ICAO  
TYPE A(OPERATING LIMITATIONS)

DIMENSIONS AND ELEVATIONS IN FEET BEARINGS ARE MAGNETIC

MAGNETIC VARIATION 7°W-APR 2015

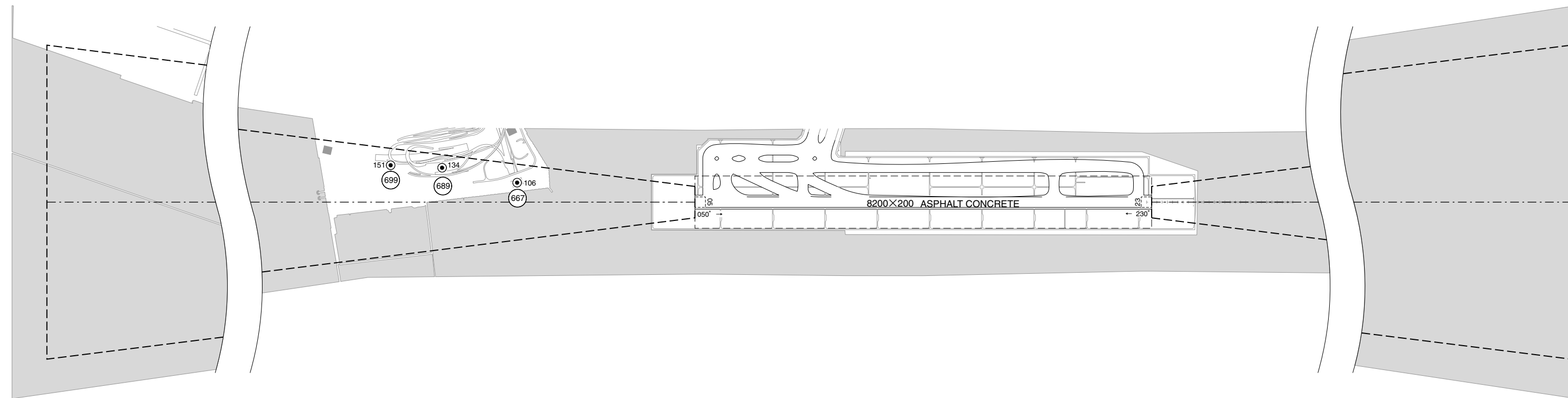
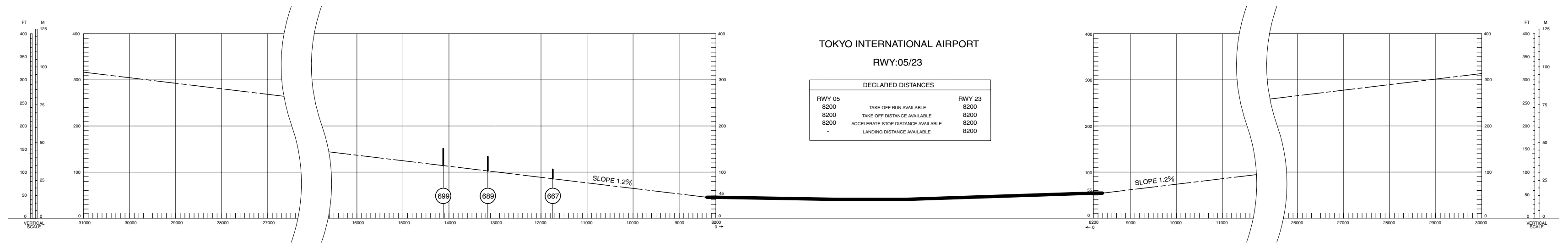

LEGEND		AMENDMENT RECORD		
		Nr	DATE	ENTERED BY
①	IDENTIFICATION NUMBER			
⊙	POLE, TOWER, SPIRE, ANTENNA, ETC			
*	TREE			
—+—	RAILROAD			
—+—	RIVER			
—+—	TRANSMISSION LINE OR OVERHEAD CABLE			
△	TRIANGULATION POINT			
★	AERONAUTICAL GROUND LIGHT			

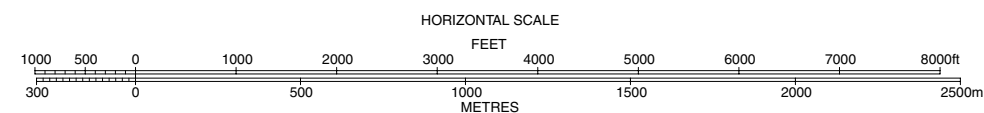

# Airspace for the advisory service concerning low level wind shear (RWY04/22)

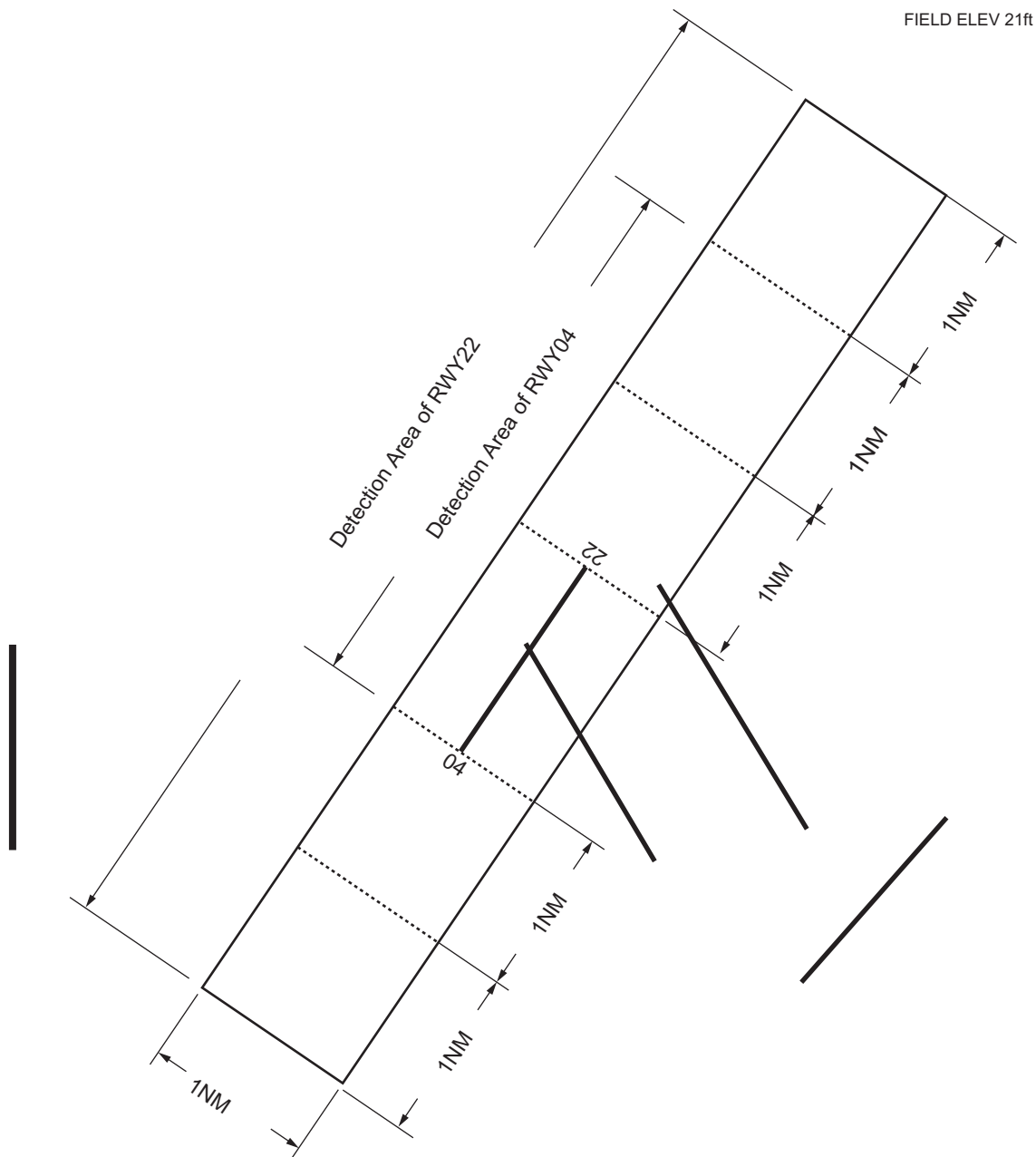

UPPER LIMIT: 1600ft above FIELD ELEV LEVEL

LOWER LIMIT: FIELD ELEV LEVEL



# Airspace for the advisory service concerning low level wind shear (RWY05/23)

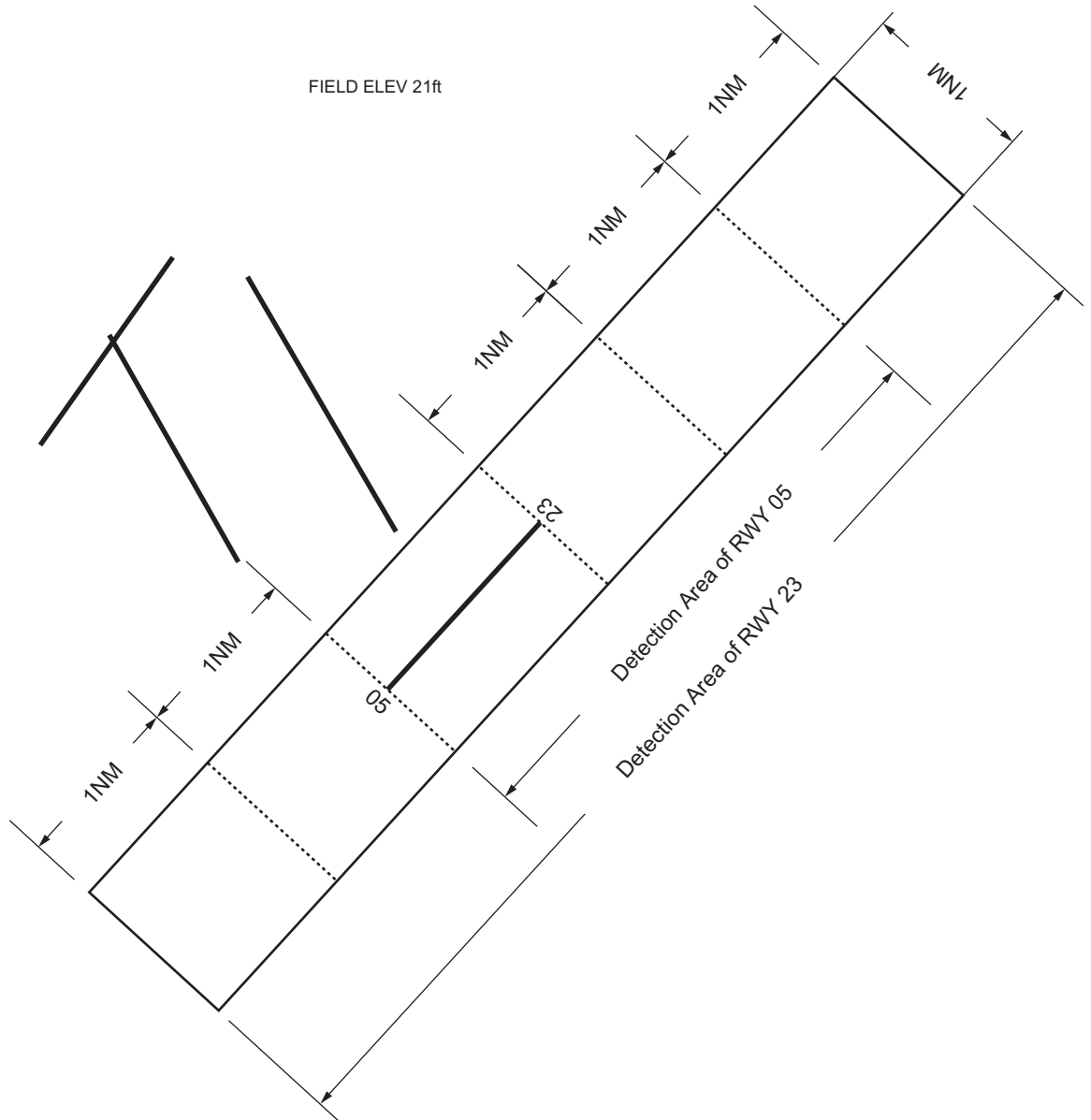

UPPER LIMIT: 1600ft above FIELD ELEV LEVEL  
LOWER LIMIT: FIELD ELEV LEVEL

# Airspace for the advisory service concerning low level wind shear (RWY16L/34R)

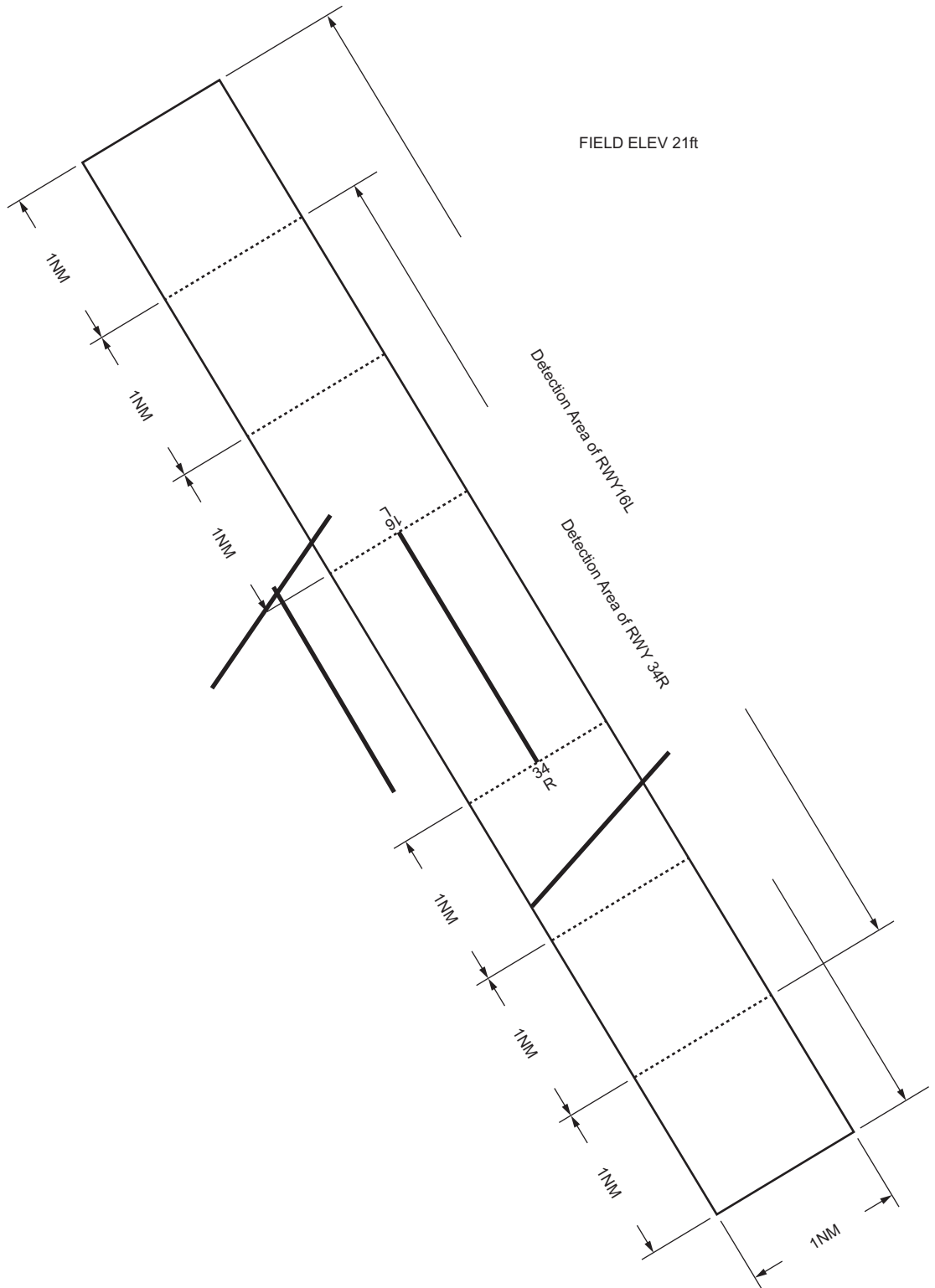

UPPER LIMIT: 1600ft above FIELD ELEV LEVEL  
LOWER LIMIT: FIELD ELEV LEVEL

# Airspace for the advisory service concerning low level wind shear (RWY16R/34L)

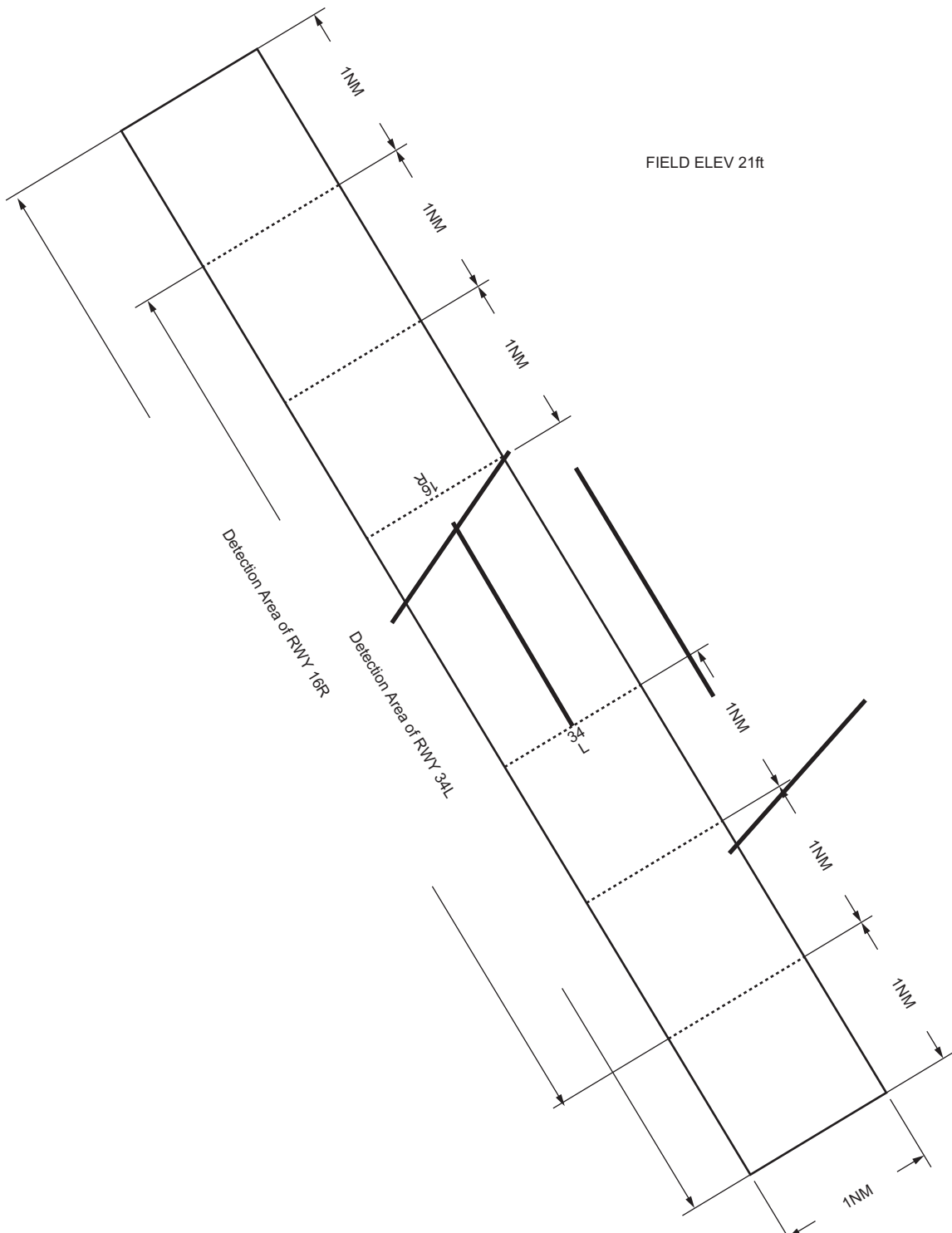

UPPER LIMIT: 1600ft above FIELD ELEV LEVEL  
LOWER LIMIT: FIELD ELEV LEVEL

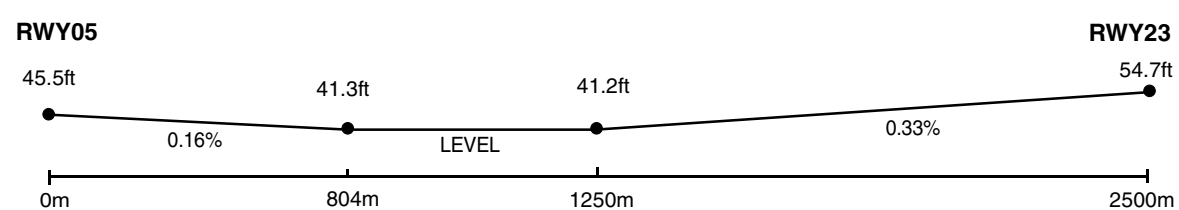
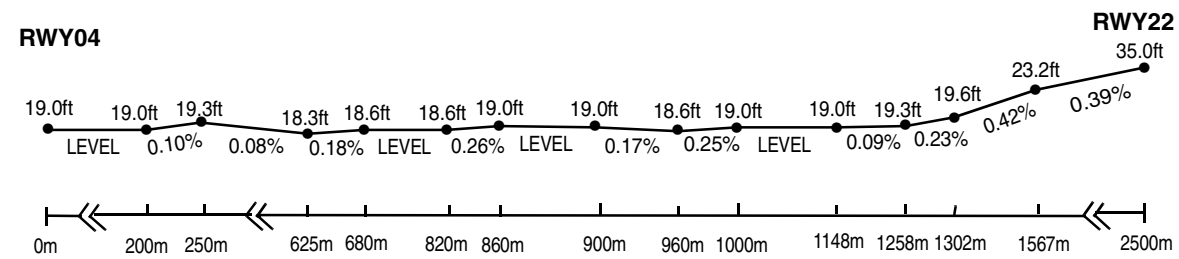
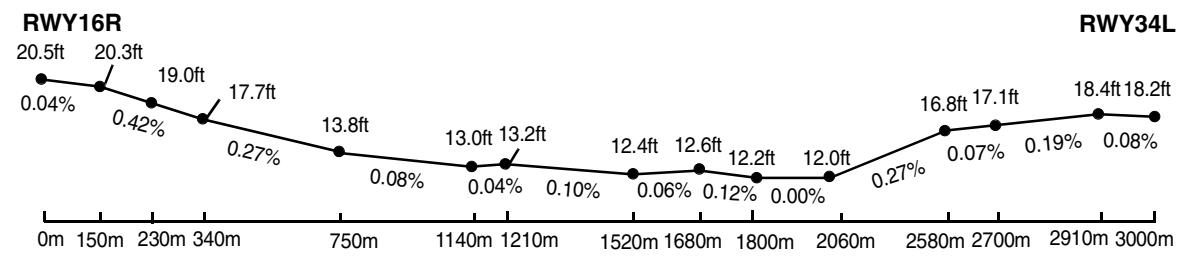
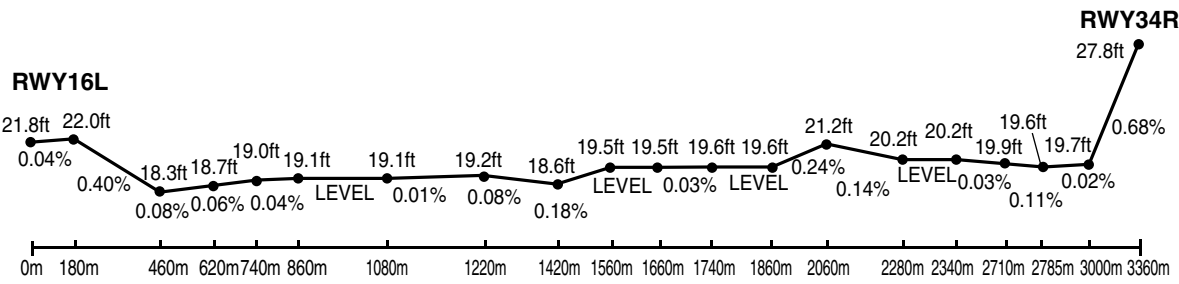

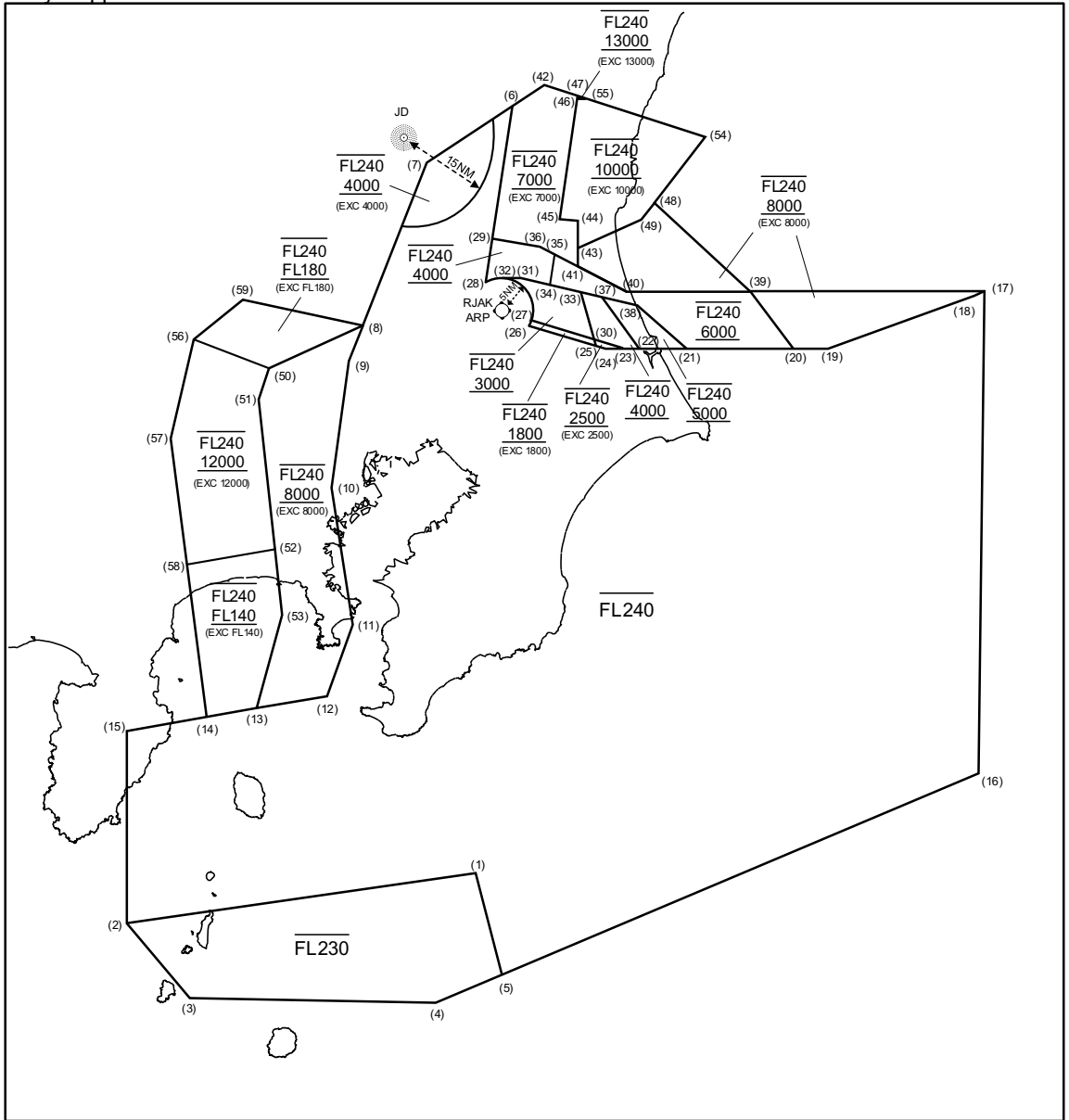

Point list

- |                       |                       |                       |                       |
|-----------------------|-----------------------|-----------------------|-----------------------|
| (1) 343224N/1400724E  | (18) 360419N/1414409E | (35) 361053N/1402147E | (52) 352343N/1392749E |
| (2) 342337N/1390033E  | (19) 355600N/1411534E | (36) 361204N/1401853E | (53) 351301N/1392926E |
| (3) 341153N/1391255E  | (20) 355600N/1410841E | (37) 360407N/1403112E | (54) 362938N/1405126E |
| (4) 341141N/1395954E  | (21) 355600N/1404746E | (38) 360250N/1403803E | (55) 363540N/1402812E |
| (5) 341614N/1401235E  | (22) 355600N/1403828E | (39) 360503N/1410017E | (56) 355626N/1390939E |
| (6) 363429N/1401317E  | (23) 355600N/1403535E | (40) 360500N/1403600E | (57) 354316N/1390433E |
| (7) 362515N/1395633E  | (24) 355600N/1403154E | (41) 360858N/1402626E | (58) 352134N/1390812E |
| (8) 355918N/1394424E  | (25) 355626N/1403002E | (42) 363752N/1401937E | (59) 360223N/1391842E |
| (9) 355339N/1394146E  | (26) 355930N/1401651E | (43) 361152N/1402623E |                       |
| (10) 353325N/1393840E | (27) 360023N/1401723E | (44) 361619N/1402619E |                       |
| (11) 351136N/1394310E | (28) 360623N/1400824E | (45) 361628N/1402245E |                       |
| (12) 350019N/1393818E | (29) 361321N/1400930E | (46) 363547N/1402606E |                       |
| (13) 345811N/1392443E | (30) 355732N/1402939E | (47) 363611N/1402610E |                       |
| (14) 345614N/1391225E | (31) 360705N/1401514E | (48) 361913N/1404125E |                       |
| (15) 345412N/1385949E | (32) 360705N/1401134E | (49) 361630N/1403849E |                       |
| (16) 344816N/1414417E | (33) 360453N/1402703E | (50) 355218N/1392608E |                       |
| (17) 360500N/1414604E | (34) 360602N/1402056E | (51) 354715N/1392411E |                       |

東京特別管制区  
Tokyo Positive Control Area

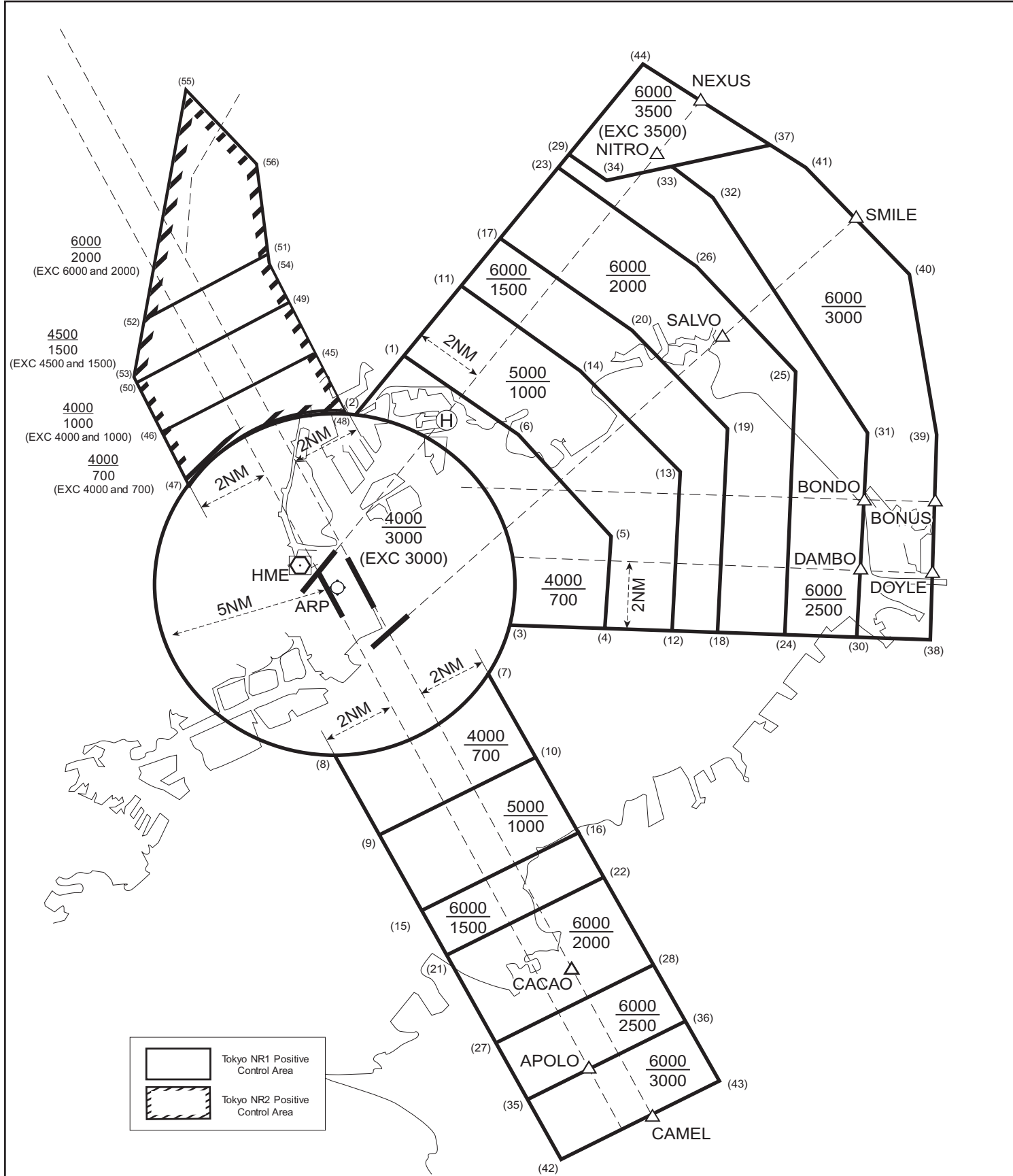

	Tokyo NR1 Positive Control Area
	Tokyo NR2 Positive Control Area

Point list

(1) 354002N/1394846E	(11) 354209N/1395037E	(21) 352228N/1395114E	(31) 353818N/1400441E	(41) 354600N/1400216E	(51) 354239N/1394357E
(2) 353811N/1394711E	(12) 353215N/1395822E	(22) 352456N/1395627E	(32) 354502N/1395905E	(42) 351636N/1395522E	(52) 354041N/1393947E
(3) 353213N/1395253E	(13) 353701N/1395821E	(23) 354546N/1395344E	(33) 354555N/1395733E	(43) 351904N/1400036E	(53) 353856N/1393931E
(4) 353215N/1395606E	(14) 353949N/1395450E	(24) 353217N/1400212E	(34) 354523N/1395526E	(44) 354857N/1395629E	(54) 354227N/1394400E
(5) 353509N/1395605E	(15) 352347N/1395018E	(25) 354009N/1400209E	(35) 351820N/1395409E	(45) 354000N/1394544E	(55) 354717N/1394047E
(6) 353758N/1395235E	(16) 352615N/1395531E	(26) 354257N/1395839E	(36) 352048N/1395923E	(46) 353732N/1394031E	(56) 354515N/1394323E
(7) 353049N/1395216E	(17) 354337N/1395153E	(27) 351957N/1395300E	(37) 354640N/1400057E	(47) 353553N/1394141E	
(8) 352812N/1394709E	(18) 353216N/1395955E	(28) 352225N/1395814E	(38) 353218N/1400711E	(48) 353812N/1394700E	
(9) 352557N/1394845E	(19) 353817N/1395953E	(29) 354610N/1395404E	(39) 353818N/1400708E	(49) 354119N/1394448E	
(10) 352825N/139558E	(20) 354105N/1395623E	(30) 353217N/1400444E	(40) 354312N/1400547E	(50) 353850N/1393935E	

東京ターミナルコントロールエリア  
Tokyo Terminal Control Area

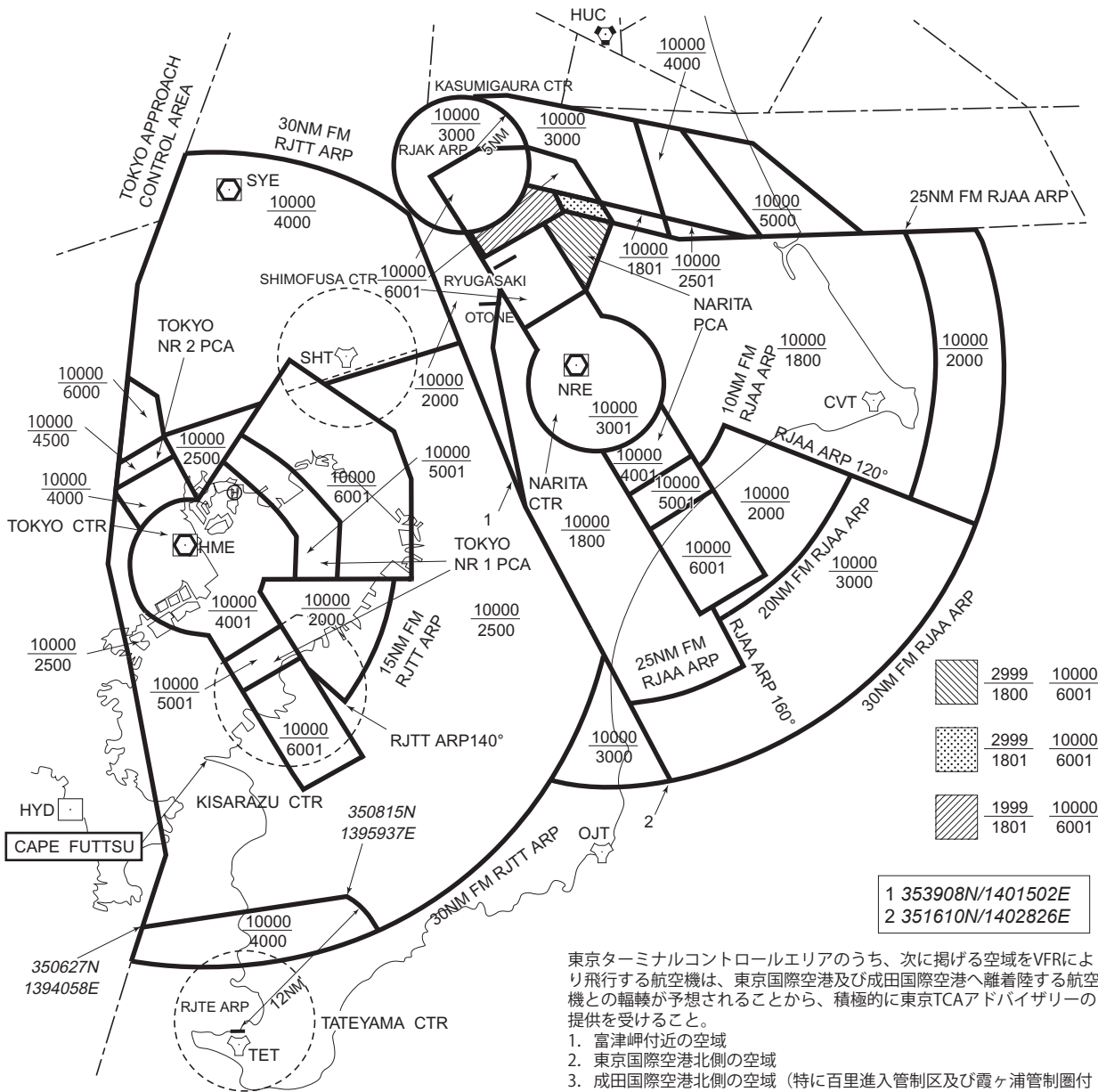

東京ターミナルコントロールエリアのうち、次に掲げる空域をVFRにより飛行する航空機は、東京国際空港及び成田国際空港へ離着陸する航空機との輻輳が予想されることから、積極的に東京TCAアドバイザーの提供を受けること。

1. 富津岬付近の空域
2. 東京国際空港北側の空域
3. 成田国際空港北側の空域 (特に百里進入管制区及び霞ヶ浦管制圏付近)

0600UTCから1000UTCを除き、東京ターミナルコントロールエリアの一部は以下のとおりとする。  
EXCEPT 0600UTC TO 1000UTC, PART OF TOKYO TERMINAL CONTROL AREA IS AS FOLLOWS.

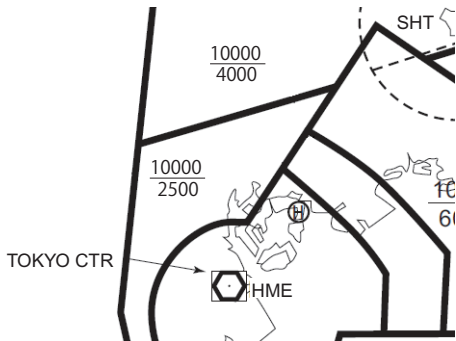

VFR AIRCRAFT ARE REQUESTED TO USE POSITIVELY TOKYO TCA ADVISORY SERVICE AROUND THE AREA LISTED BELOW WITHIN TOKYO TERMINAL CONTROL AREA.

1. AROUND CAPE FUTTSU
2. THE NORTHERN AREA OF RJJT
3. THE NORTHERN AREA OF RJAA (ESPECIALLY NEAR HYAKURI ACA AND KASUMIGAUURA CTR)

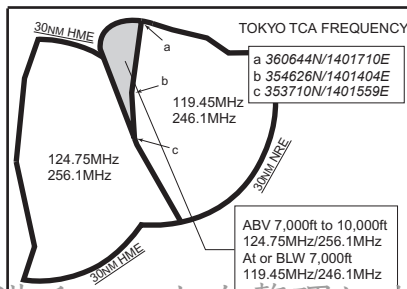

## ILS for RWY 16R

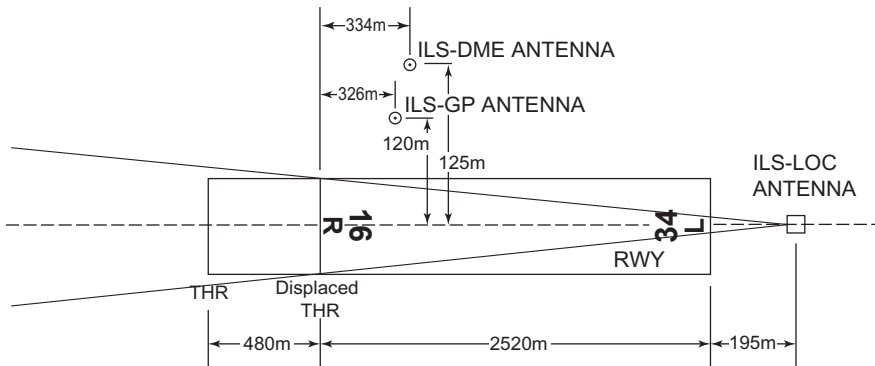

REMARKS :	1. LOC beam BRG (MAG)	157.41°
	2. HGT of ILS REF datum	16.3m(53ft)
	3. GP Angle	3.0°
	4. ELEV of ILS-DME	9.4m(31ft)

## ILS for RWY 16L

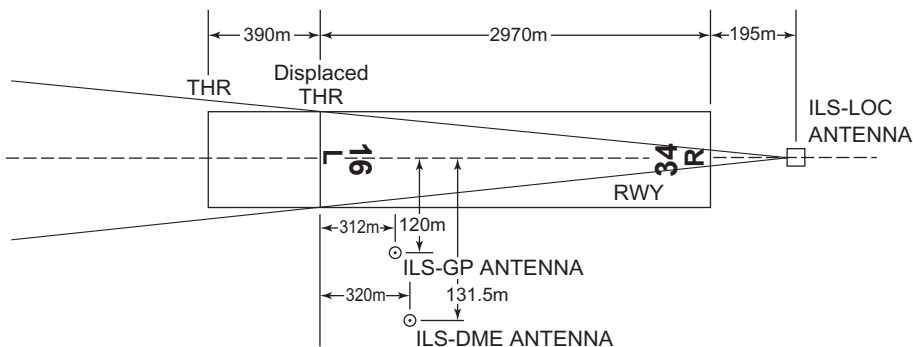

REMARKS :	1. LOC beam BRG (MAG)	157.41°
	2. HGT of ILS REF datum	16.3m(53ft)
	3. GP Angle	3.0°
	4. ELEV of ILS-DME	10.1m(34ft)



### LDA for RWY 22

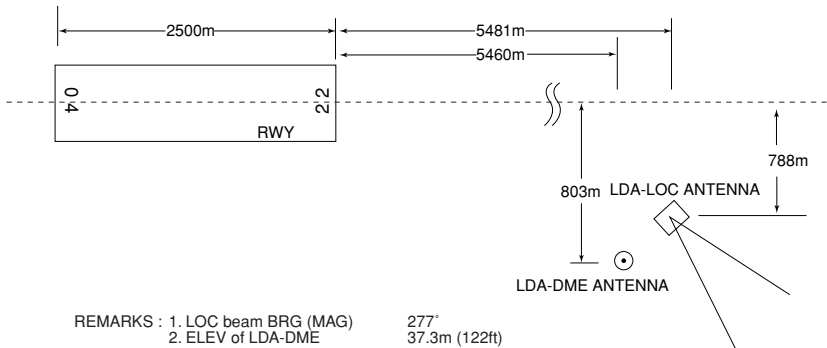

REMARKS : 1. LOC beam BRG (MAG)  
2. ELEV of LDA-DME

277°  
37.3m (122ft)

### ILS for RWY 23

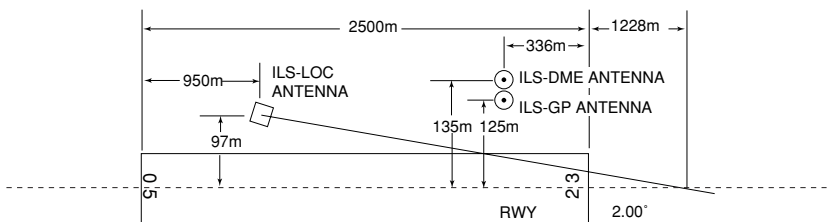

REMARKS : 1. LOC OFF SET ANGLE  
2. LOC beam BRG (MAG)  
3. HGT of ILS REF datum  
4. GP Angle  
5. ELEV of ILS-DME

2.00°  
232°  
16.5m (54ft)  
3.0°  
20.5m (67ft)

### LDA for RWY 23

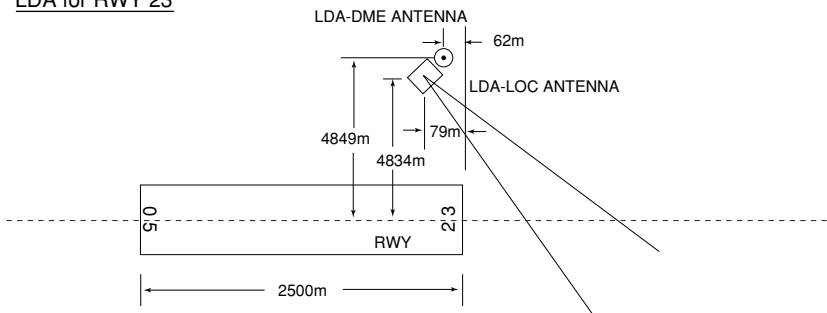

REMARKS : 1. LOC beam BRG (MAG)  
2. ELEV of ILS-DME

277°  
10.3m (34ft)

# GROUND CONTROL Frequency

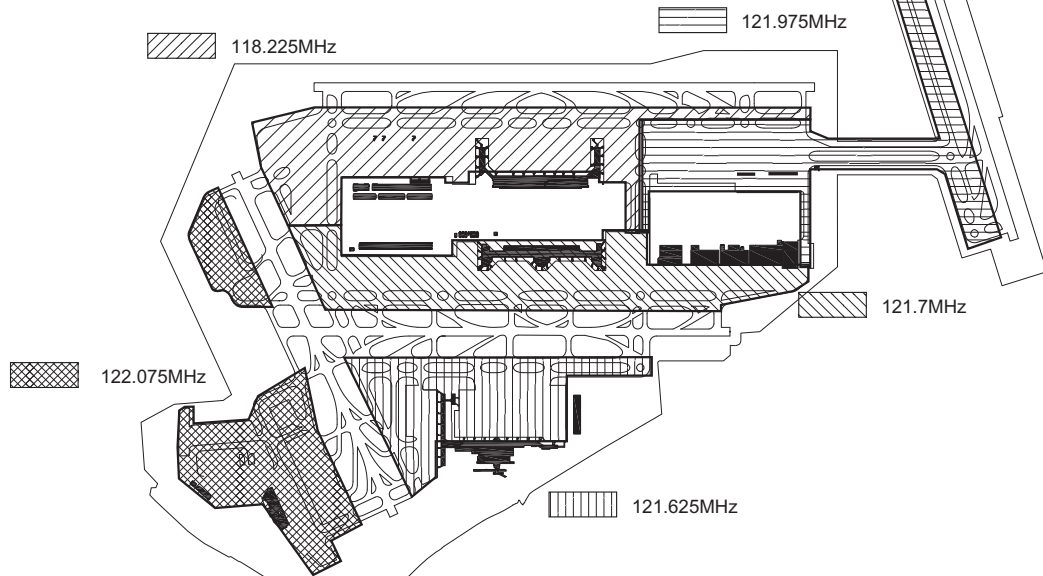

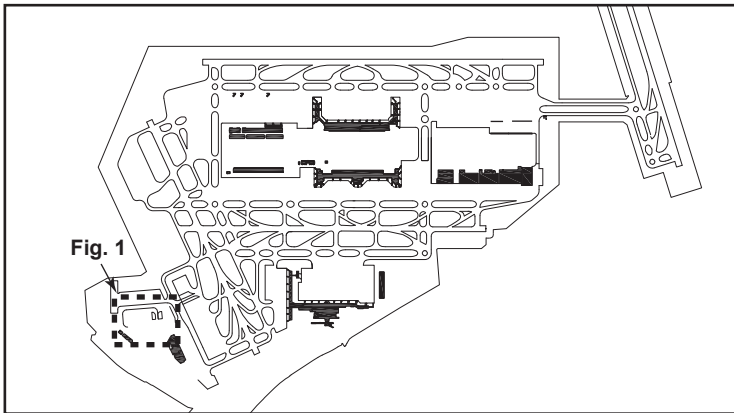
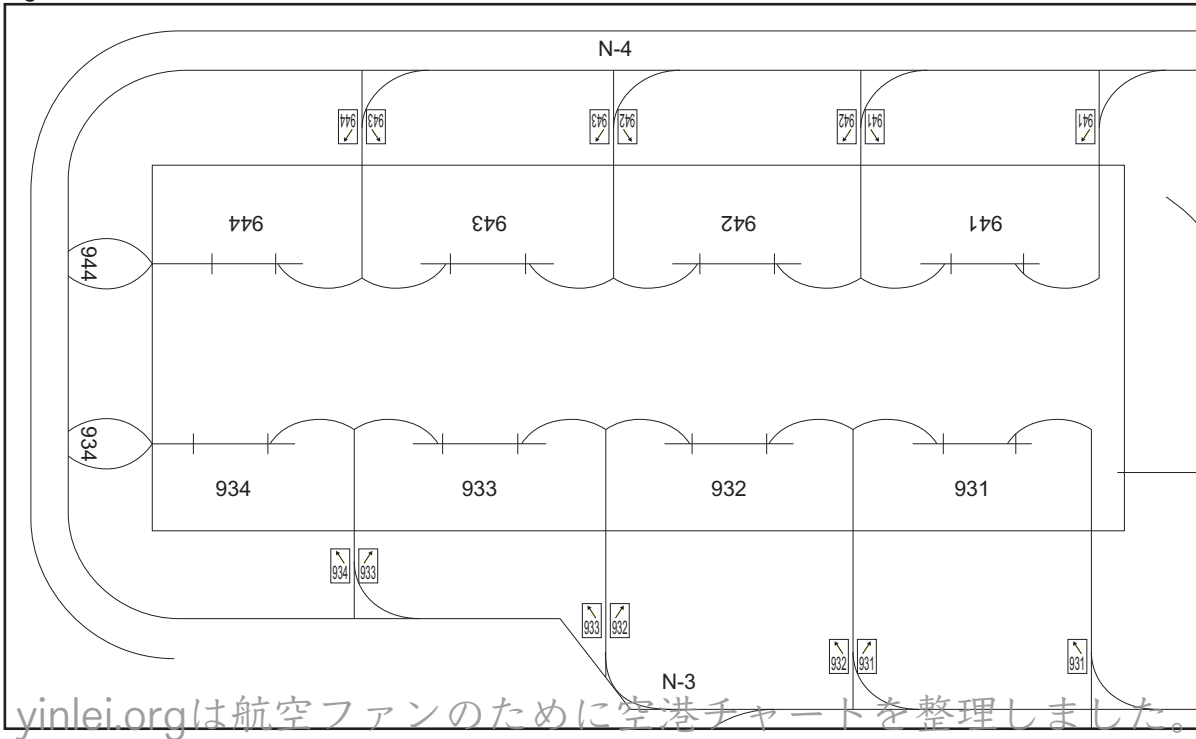
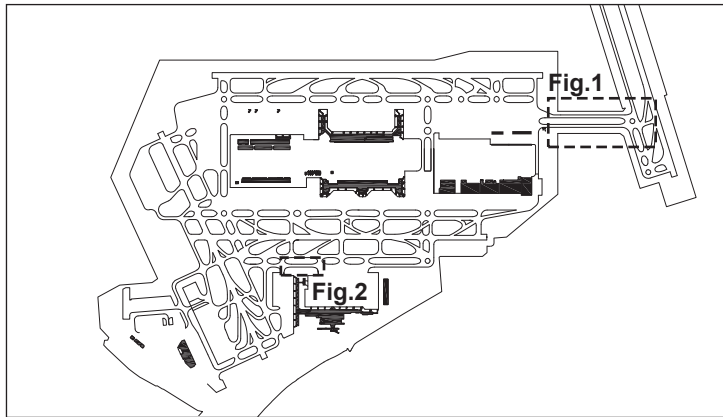
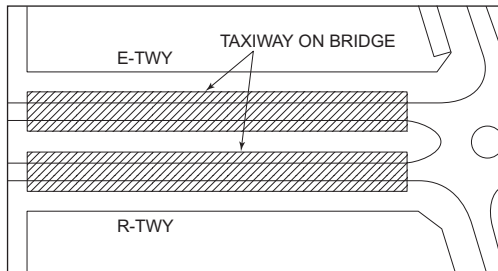

Fig. 1

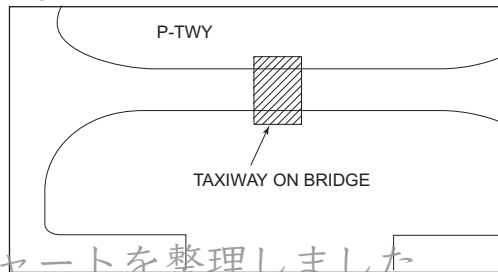

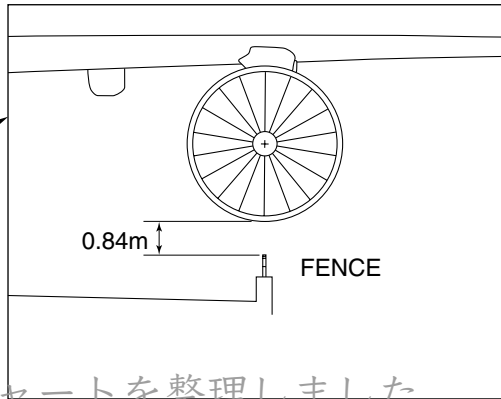
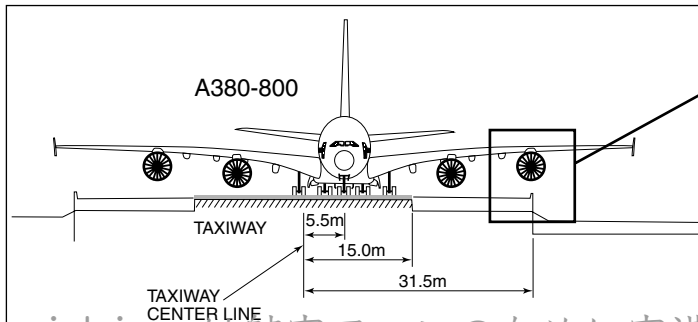

**Fig.1**



**Fig.2**





yinlei.orgは航空ファンのために空港チャートを整理しました。

Stop line marking on the taxiing guide line for spot NR 105F (See 6.5(3))

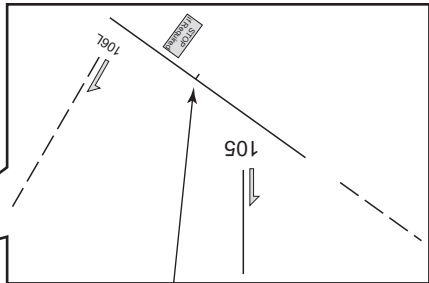
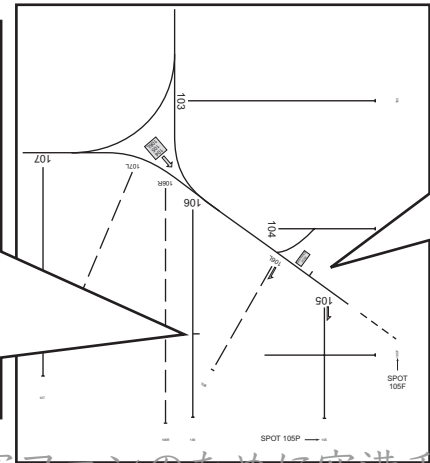
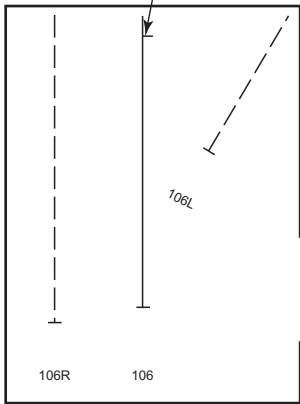

Stop line marking on the taxiing guide line for spot NR 105P (See 6.5(2))

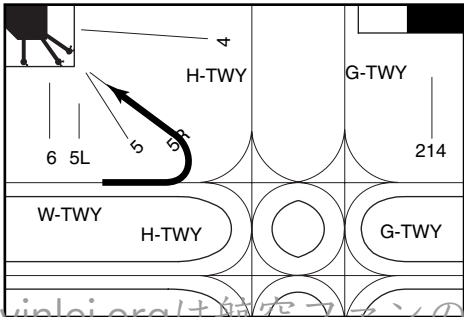

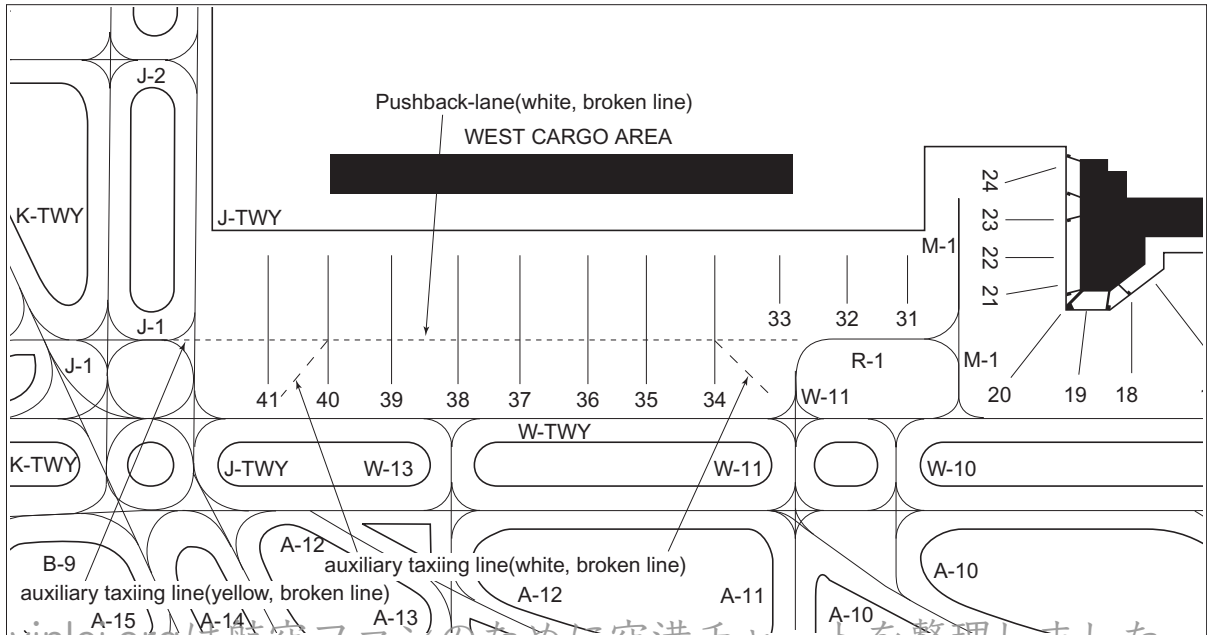



TAXIING ROUTE to RWY05 or from RWY23

Route ID	Direction	Routing Via
Route 5	To RWY05	TWY A-R-S
	From RWY23	TWY S-R-A

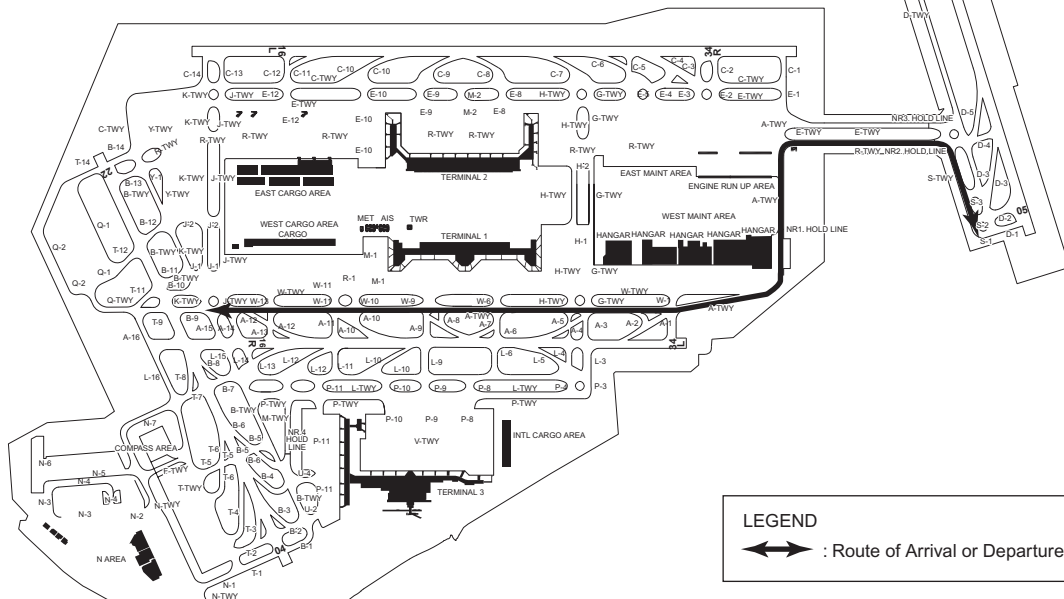

LEGEND

↔ : Route of Arrival or Departure

# A340-500における注意して走行すべき誘導路 TWY required to pay special attention for A340-500

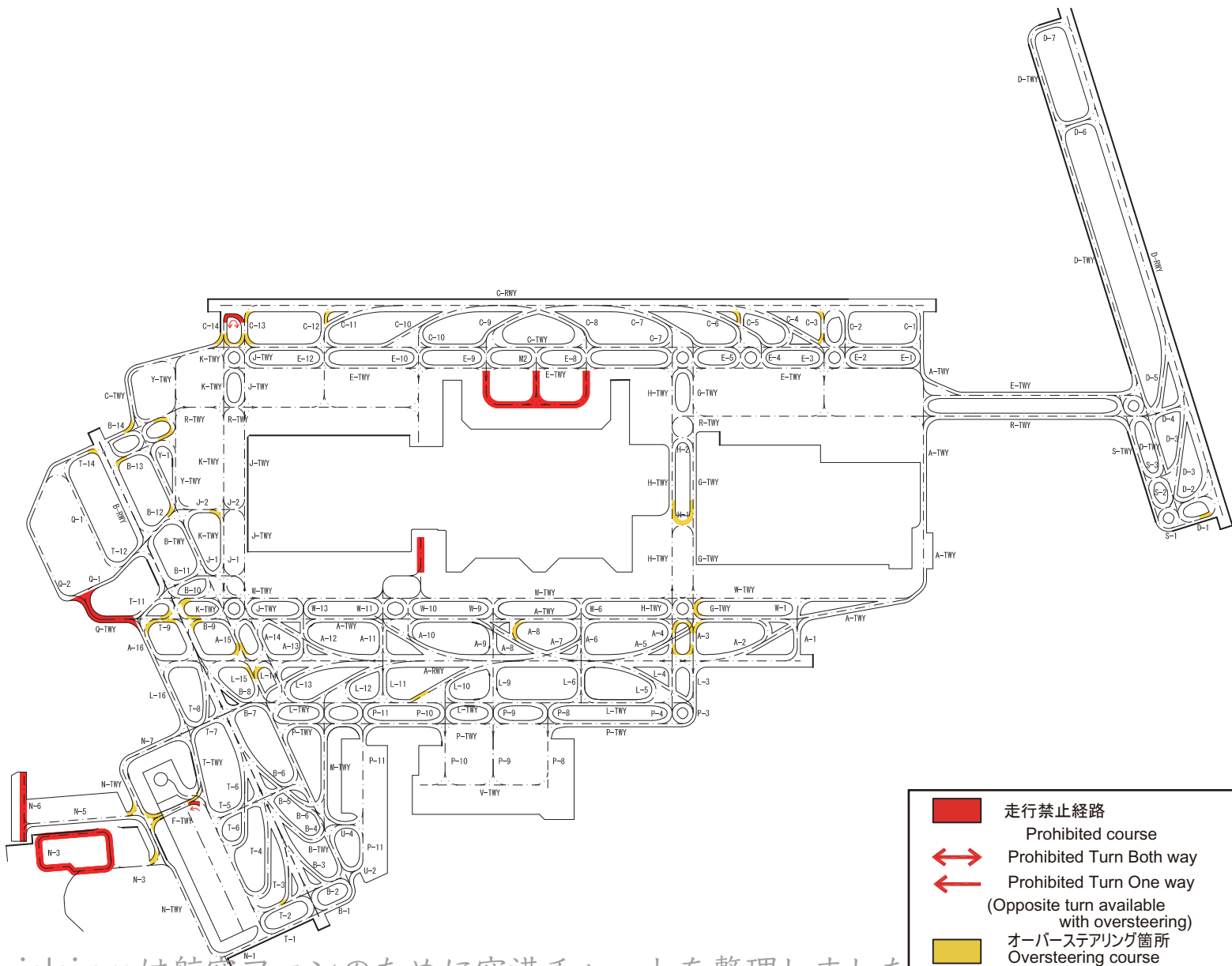

# A340-600における注意して走行すべき誘導路 TWY required to pay special attention for A340-600

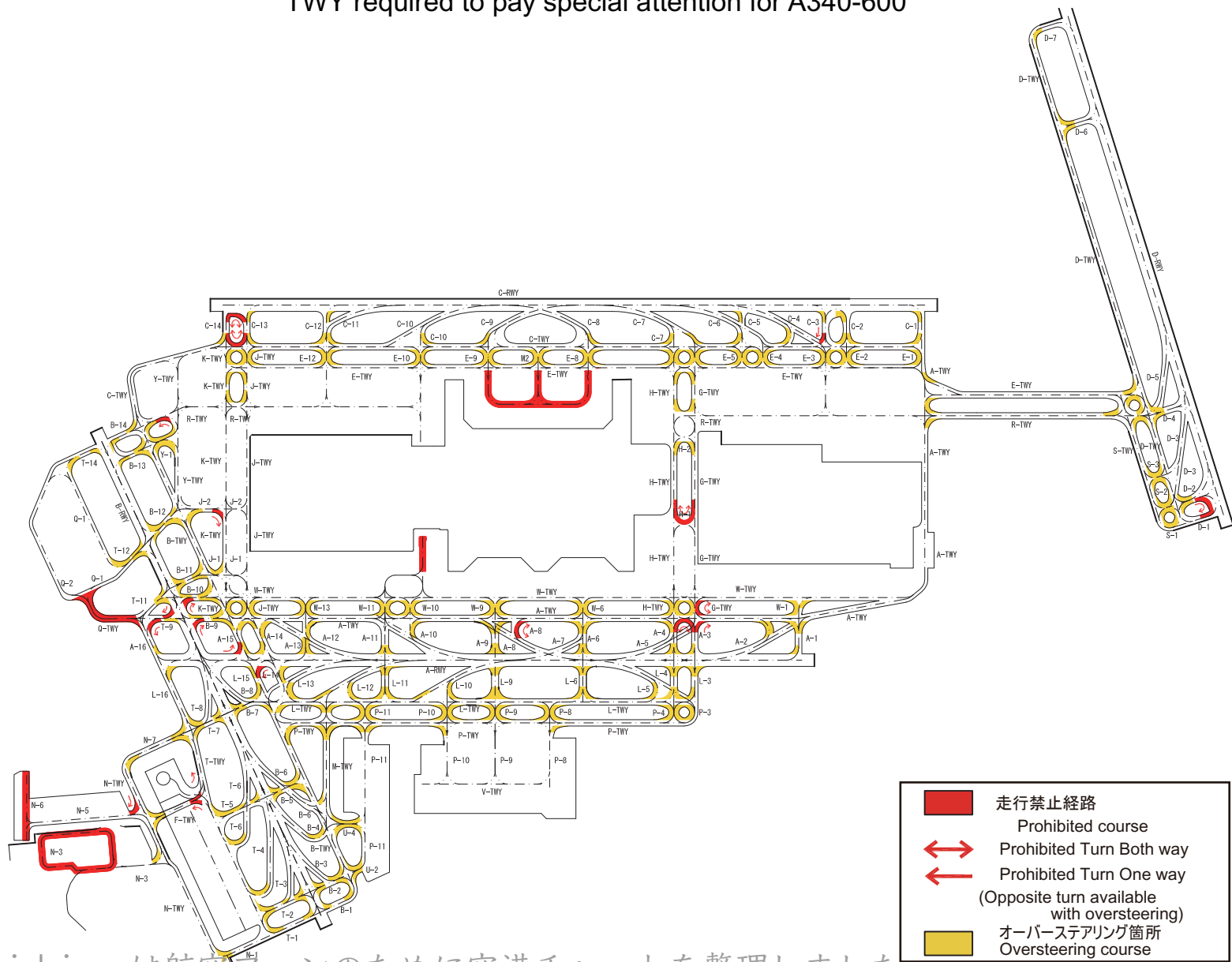

# A350-1000における注意して走行すべき誘導路

## TWY required to pay special attention for A350-1000

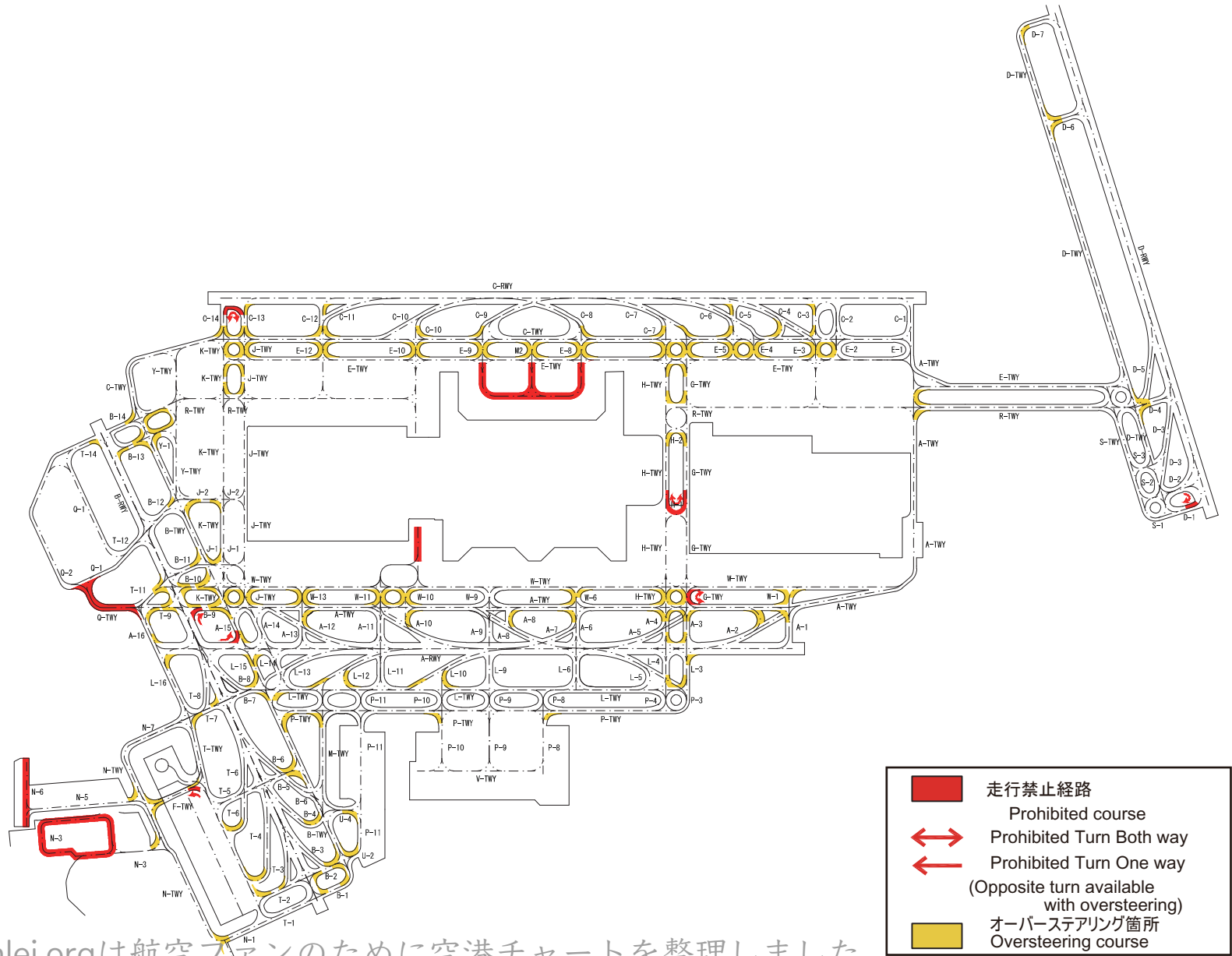

# A350-900における注意して走行すべき誘導路 TWY required to pay special attention for A350-900

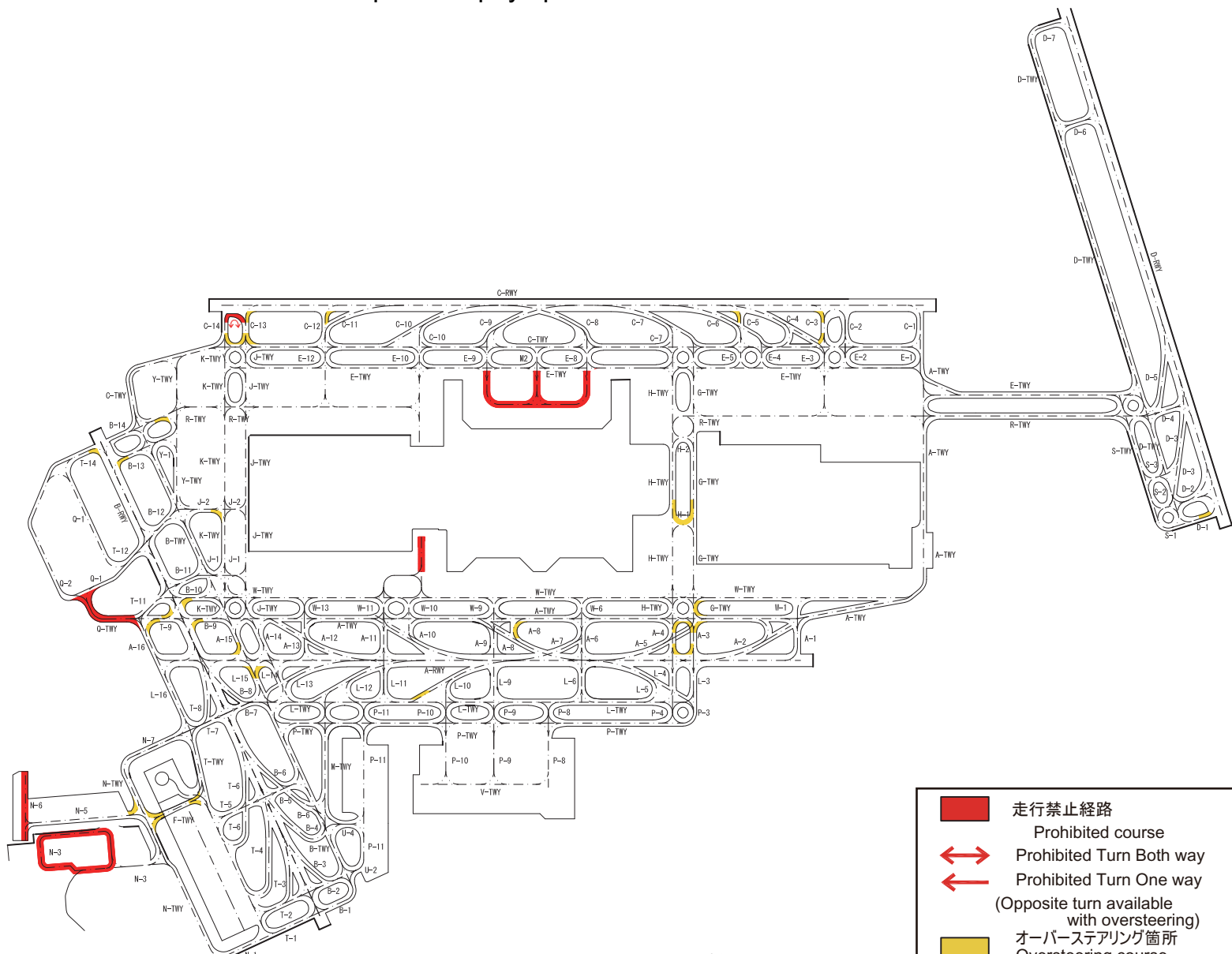

# A380-800における注意して走行すべき誘導路 TWY required to pay special attention for A380-800

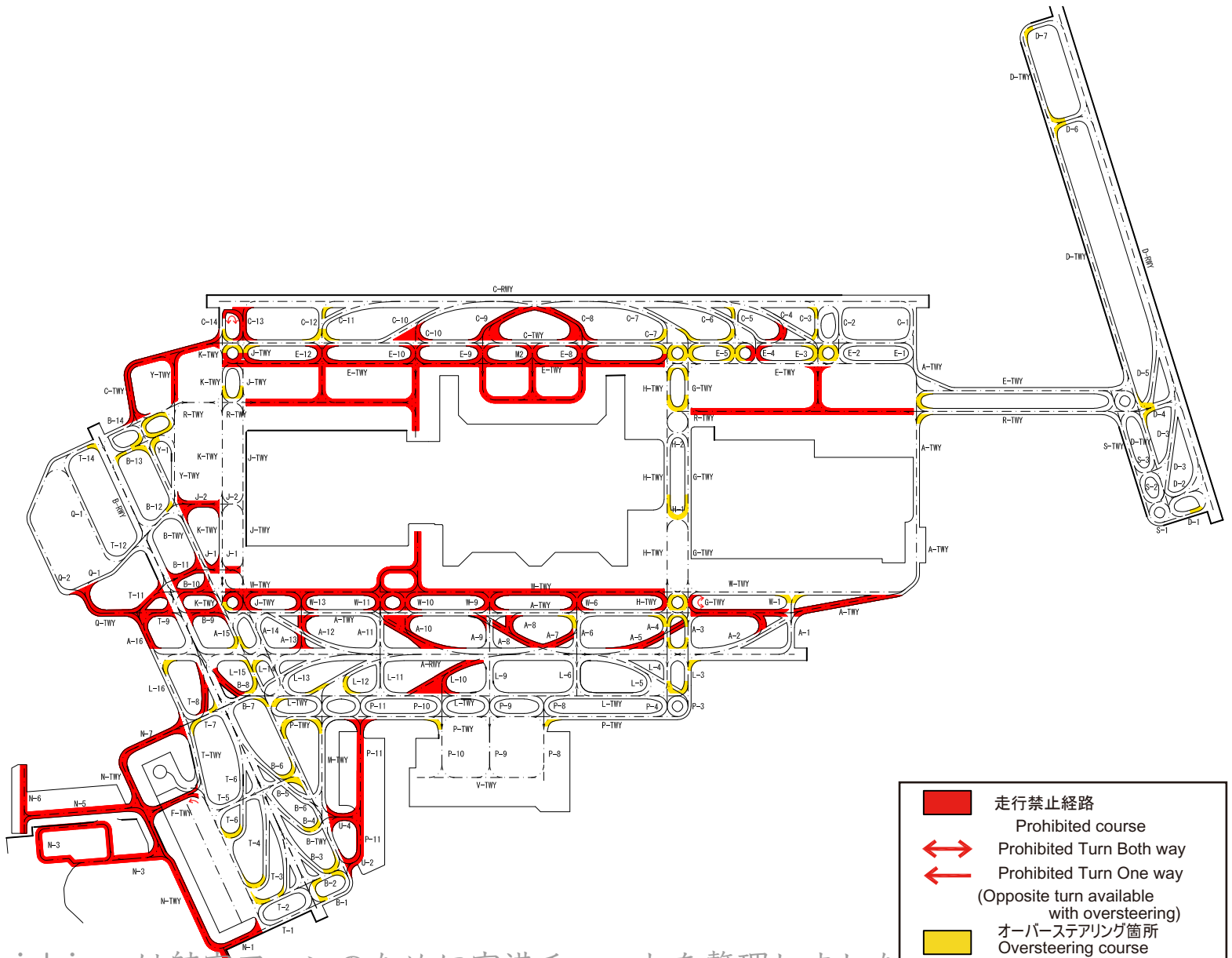

# B747-8における注意して走行すべき誘導路

## TWY required to pay special attention for B747-8

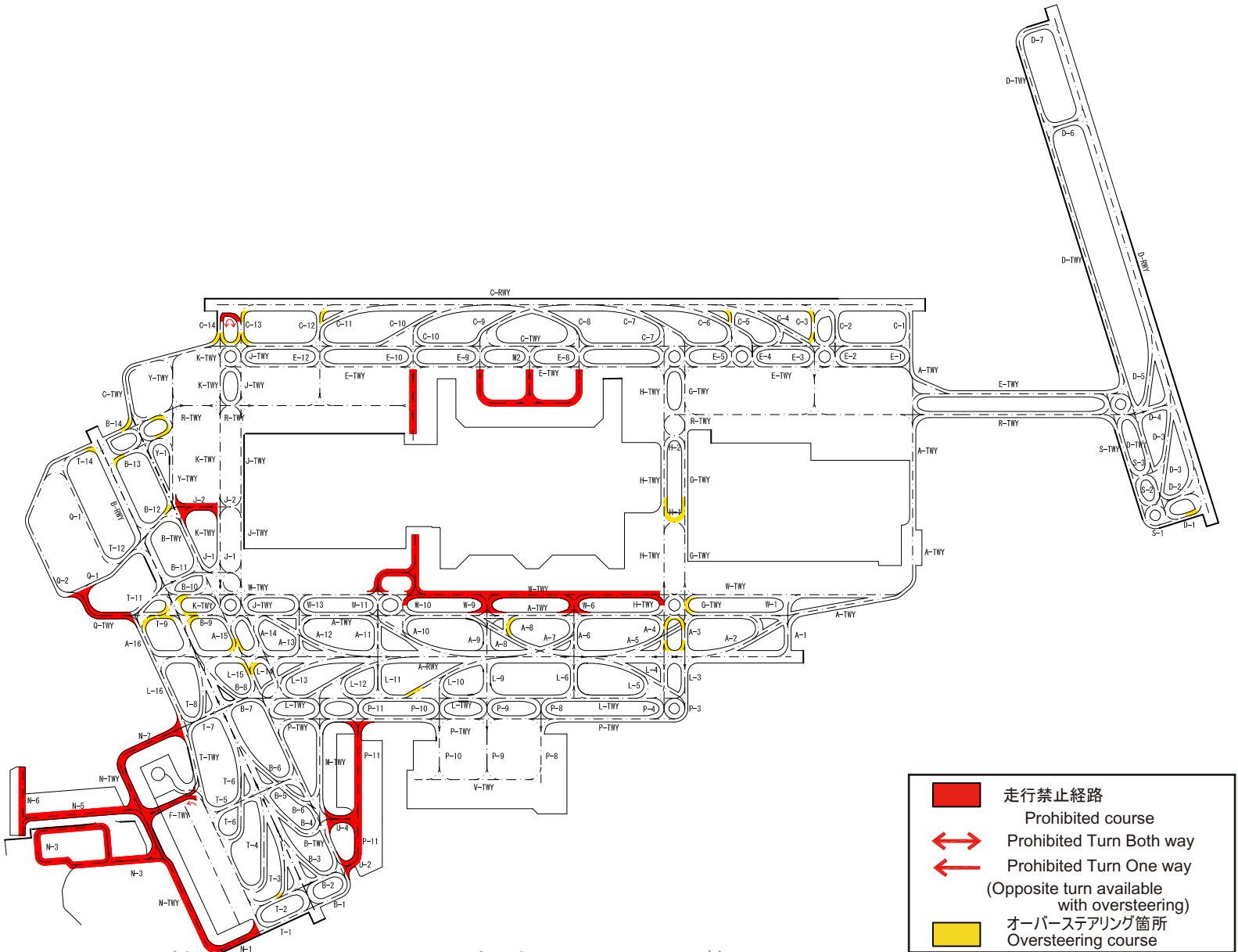

# B767-400ERにおける注意して走行すべき誘導路

## TWY required to pay special attention for B767-400ER

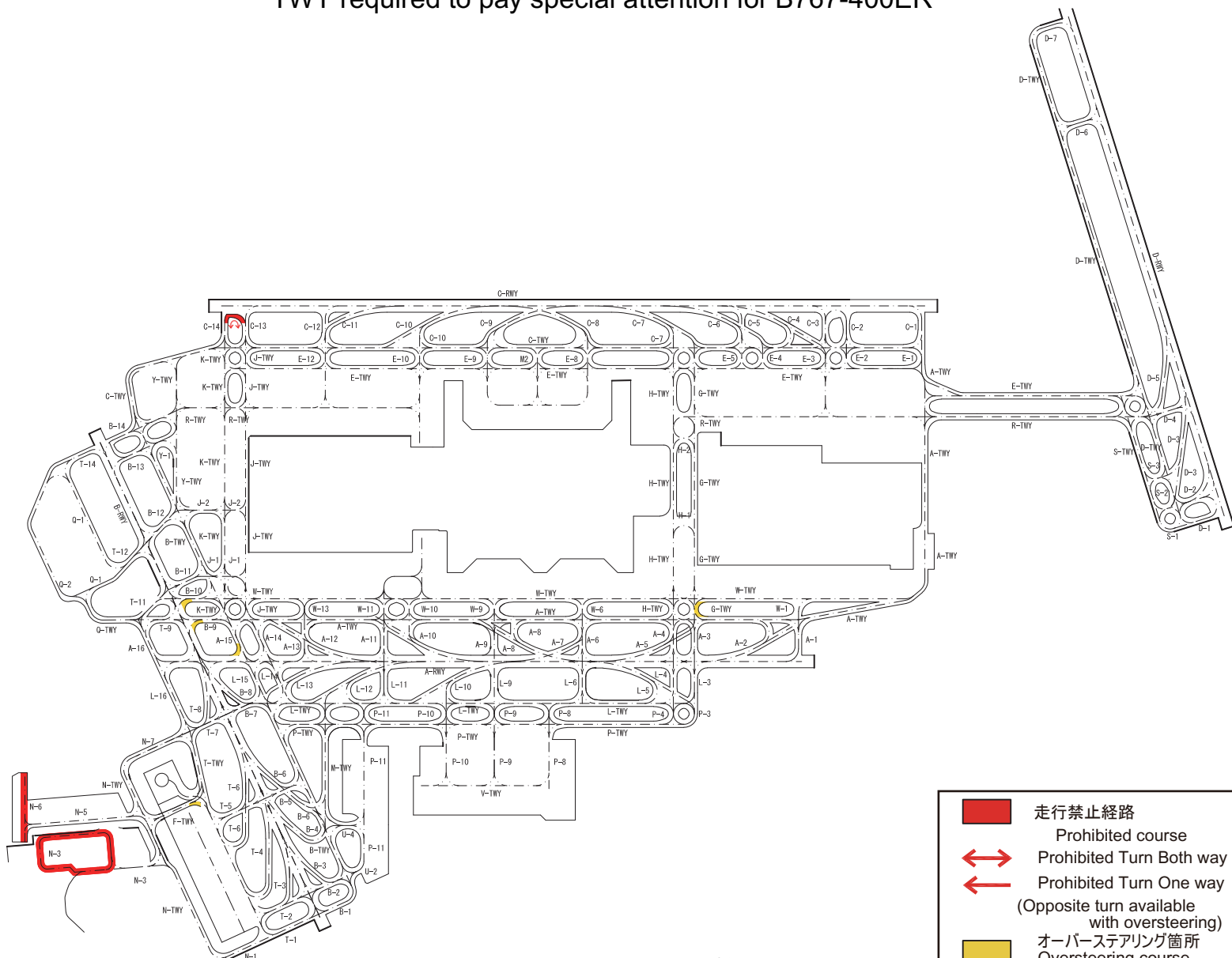



# B777-300における注意して走行すべき誘導路

## TWY required to pay special attention for B777-300

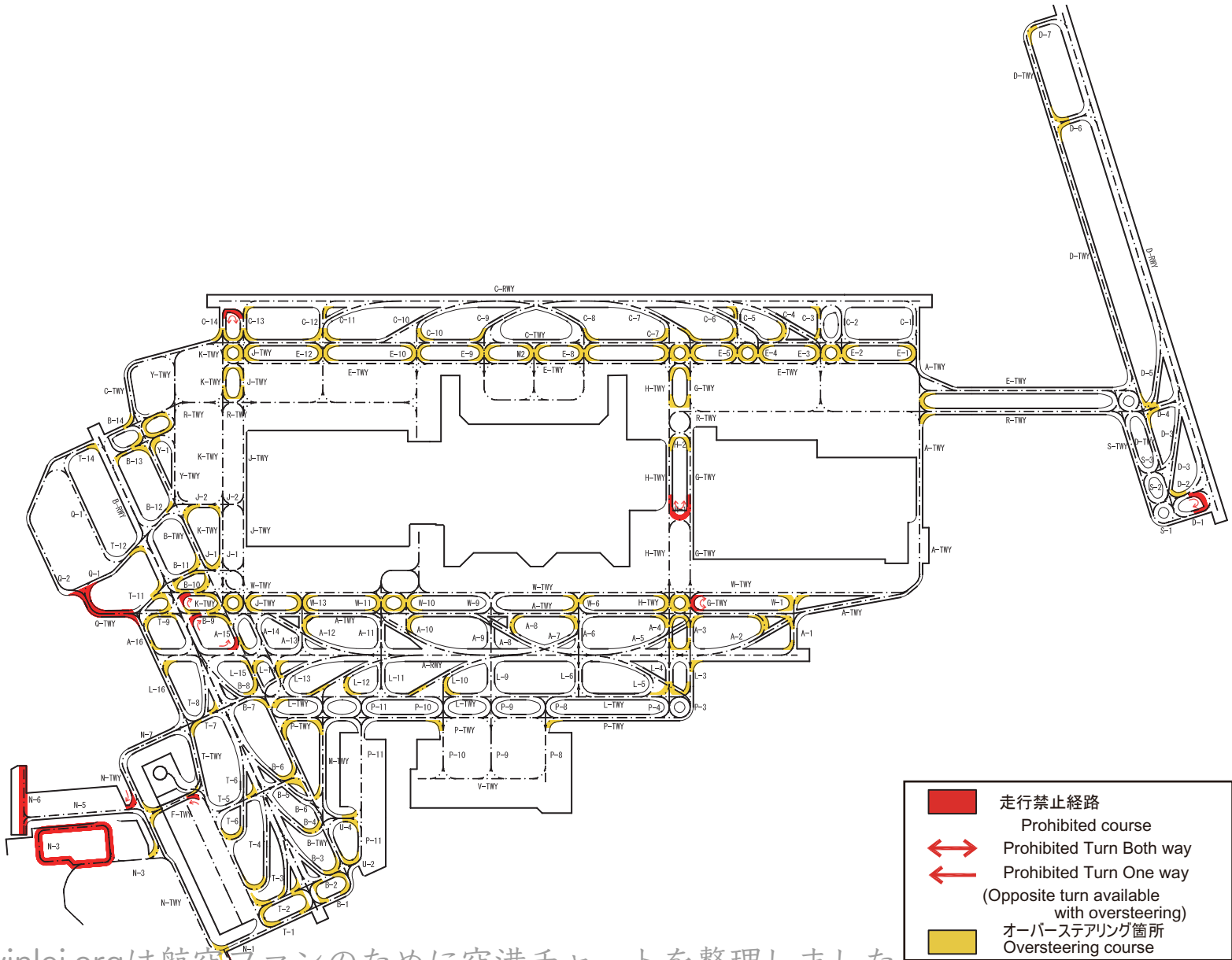

B777-300ERにおける注意して走行すべき誘導路  
 TWY required to pay special attention for B777-300ER

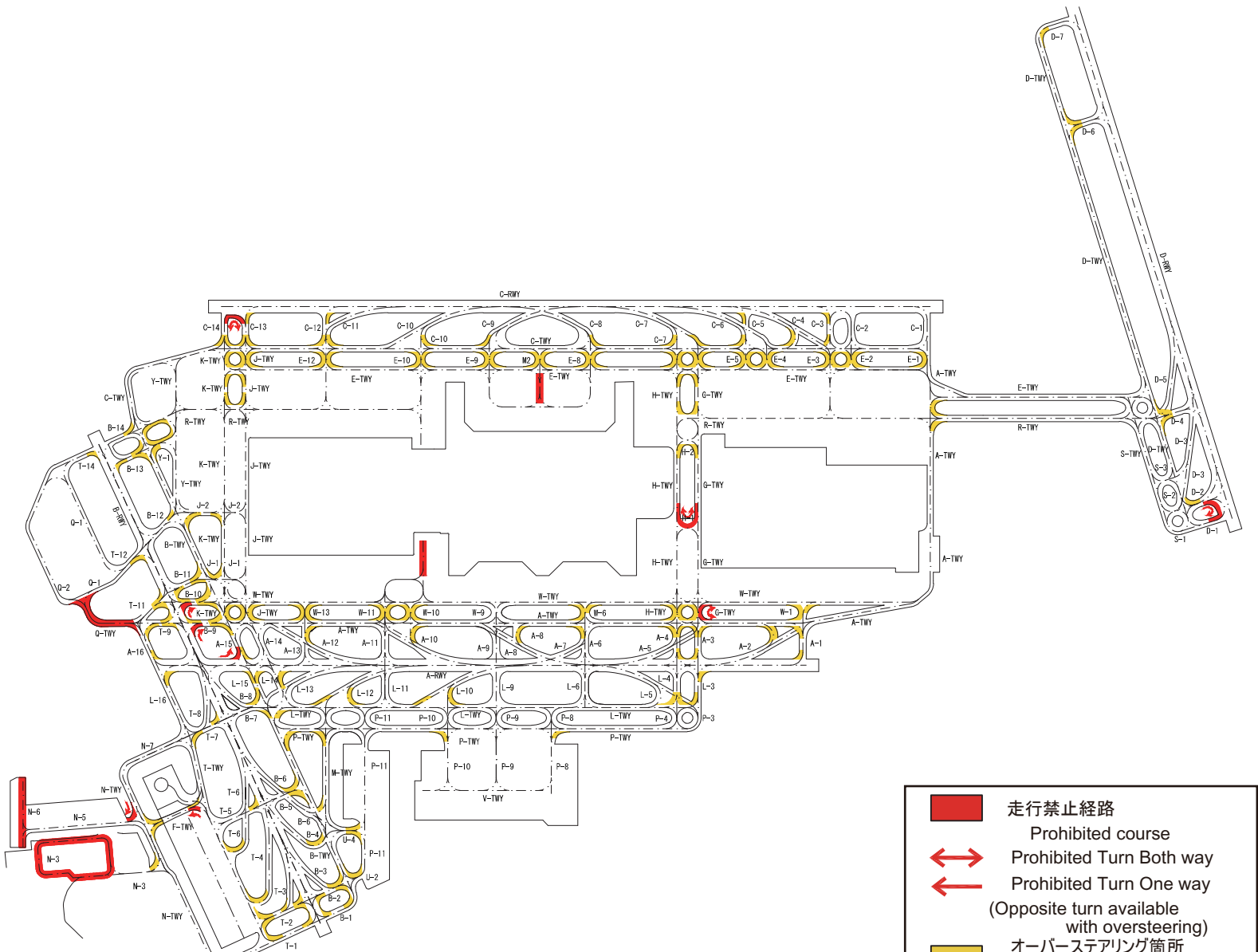

- 走行禁止経路  
Prohibited course
- Prohibited Turn Both way
- Prohibited Turn One way  
(Opposite turn available with oversteering)
- オーバーステアリング箇所  
Oversteering course

# B787-10における注意して走行すべき誘導路 TWY required to pay special attention for B787-10

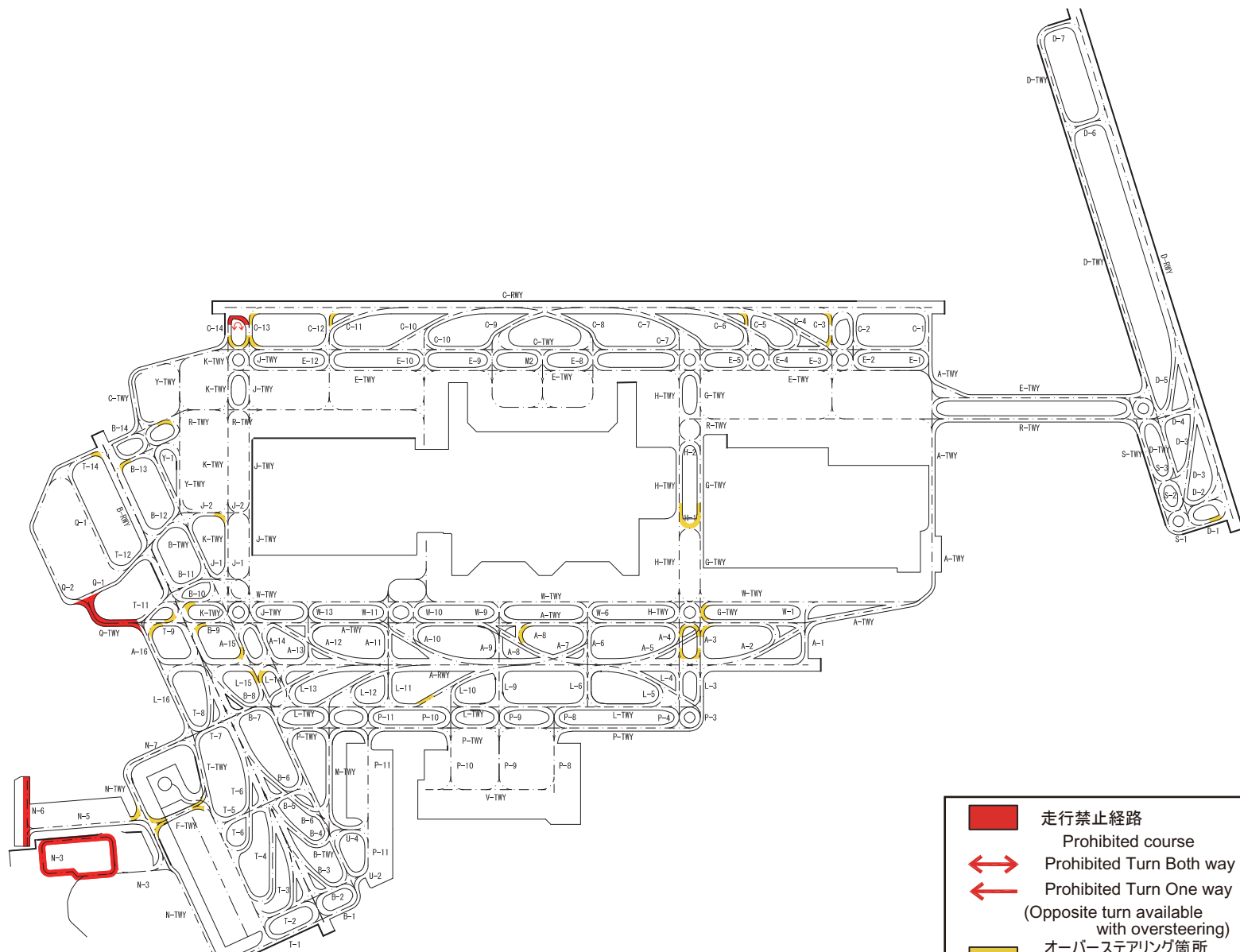

# B787-8における注意して走行すべき誘導路 TWY required to pay special attention for B787-8

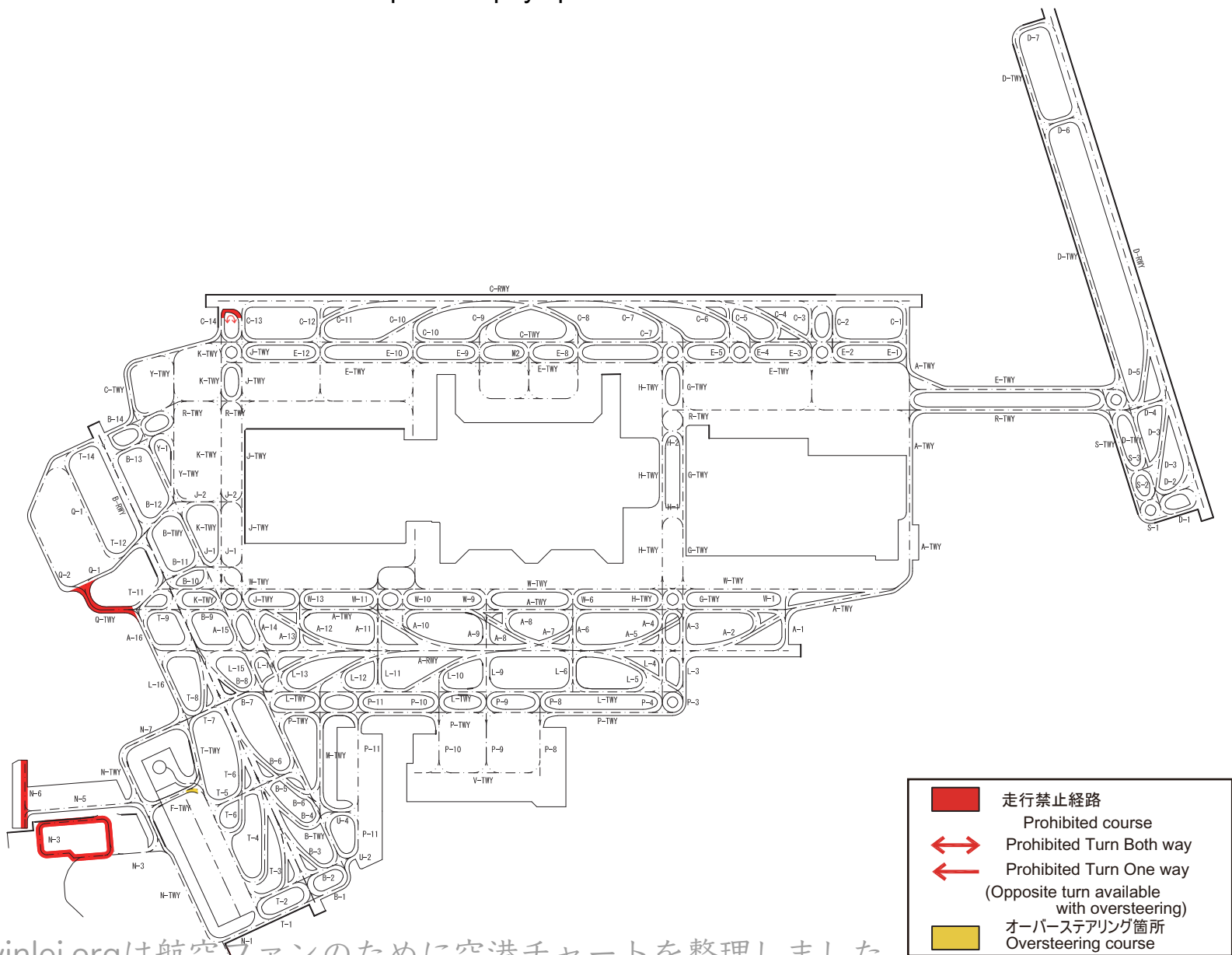

# B787-9における注意して走行すべき誘導路 TWY required to pay special attention for B787-9

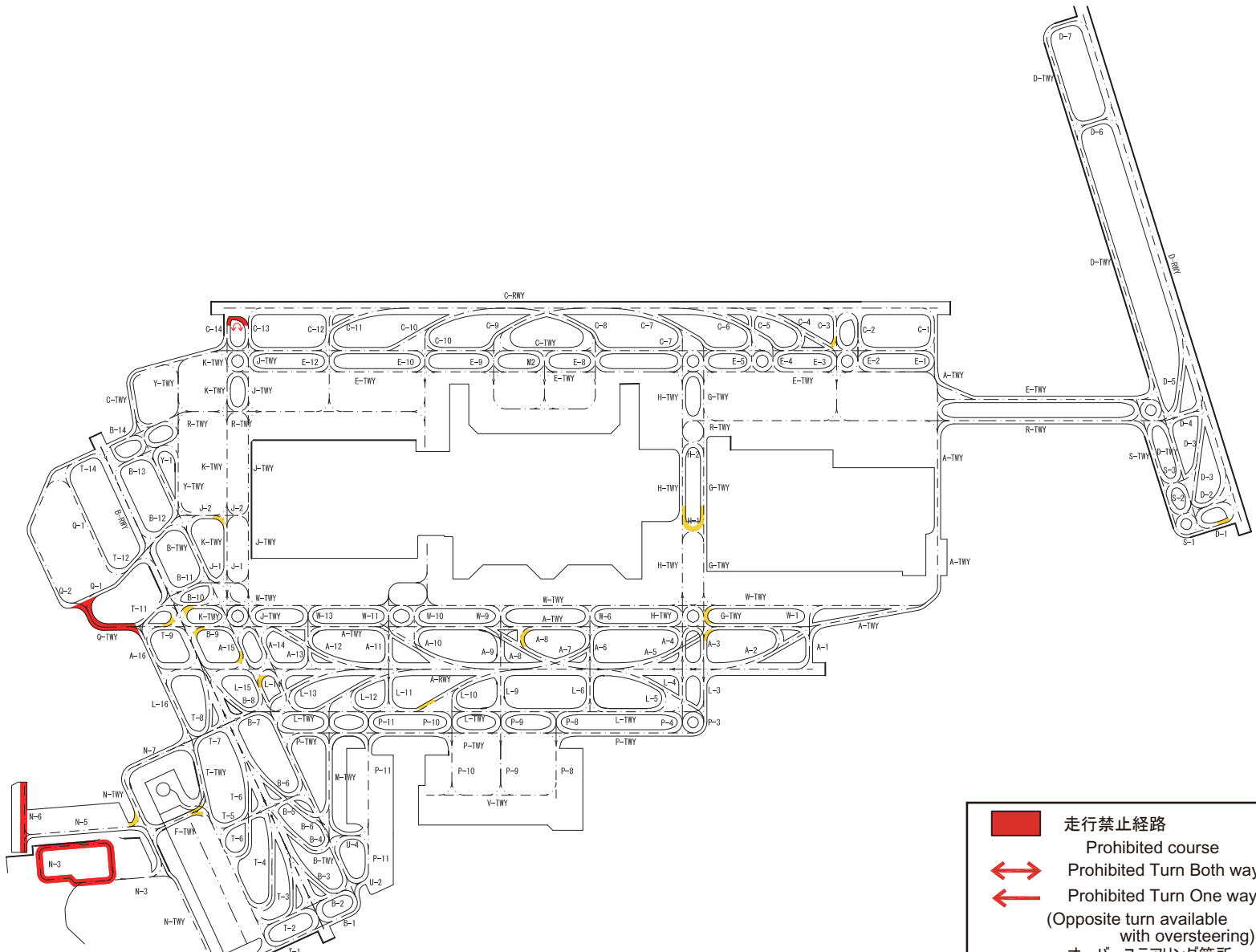

- 走行禁止経路  
Prohibited course
- Prohibited Turn Both way
- Prohibited Turn One way  
(Opposite turn available with oversteering)
- オーバーステアリング箇所  
Oversteering course

# Preferential Routes and Aircraft Operating Procedures for Noise Abatement (For General)

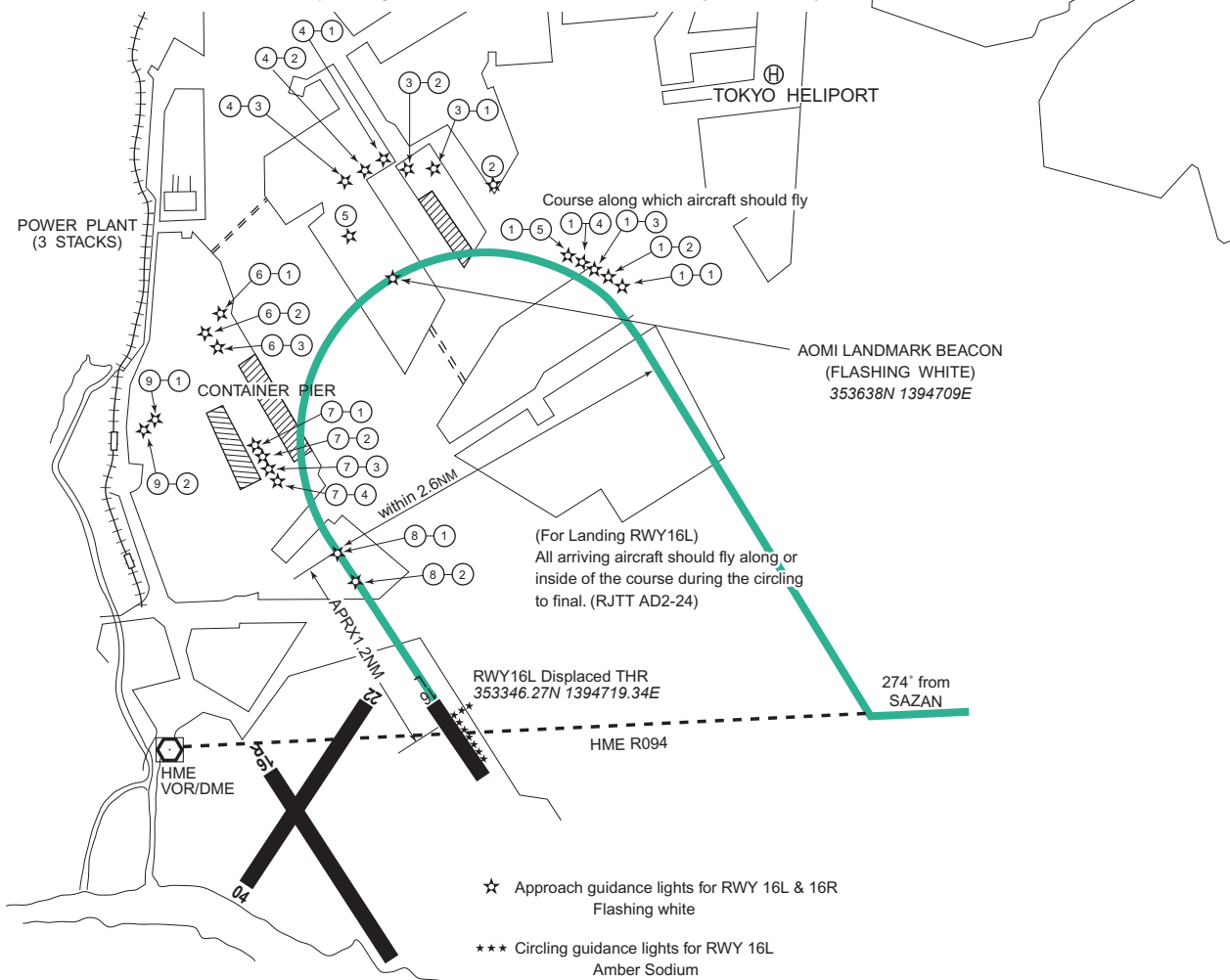

# SPECIAL VFR FLIGHT ROUTE FOR HELICOPTER

Special VFR flight route for helicopter in  
the TOKYO Control ZONE

Daishibashi - (along the Tama River) - Marukobashi

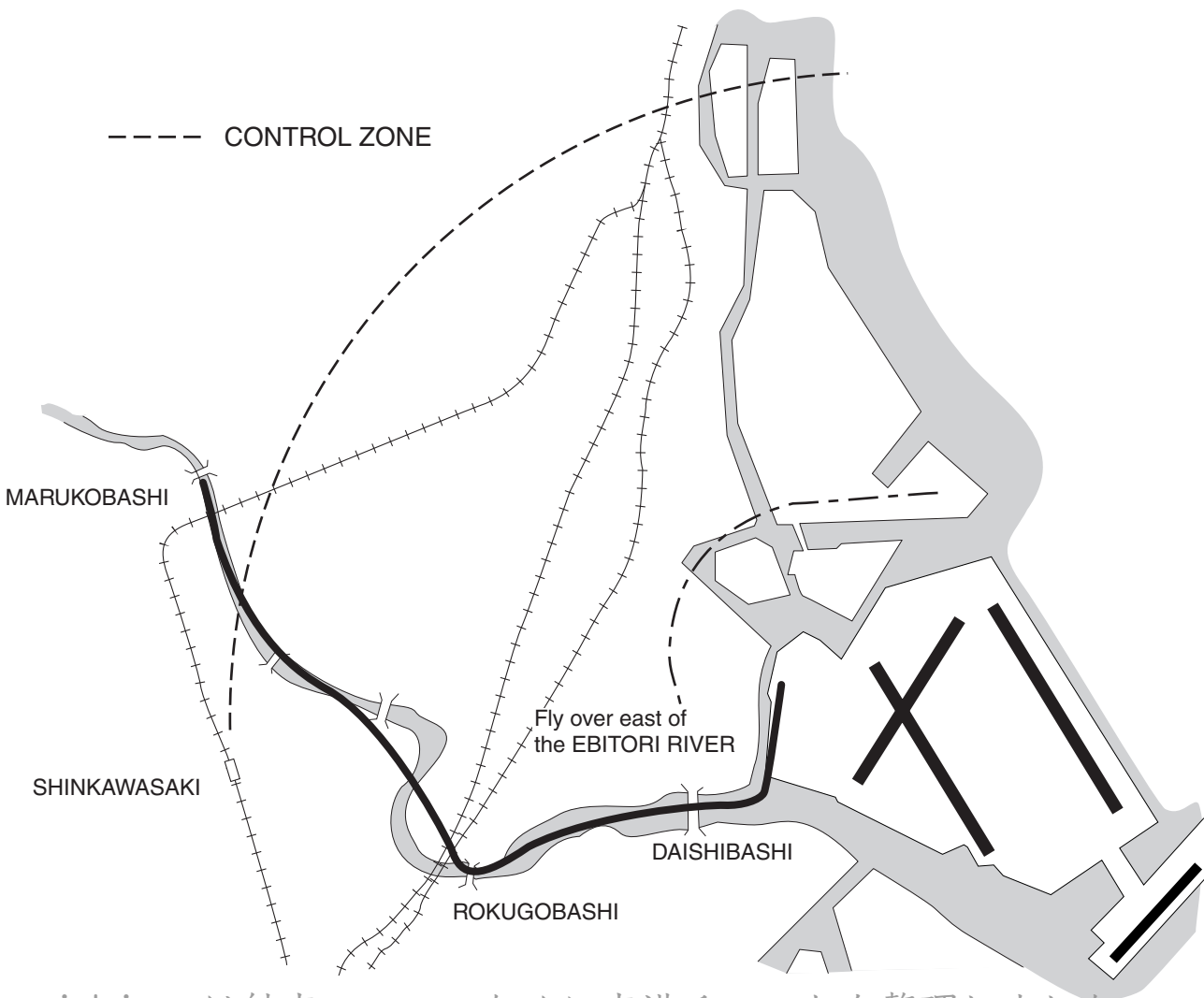

# Tokyo West passage Route and Adjacent sea area

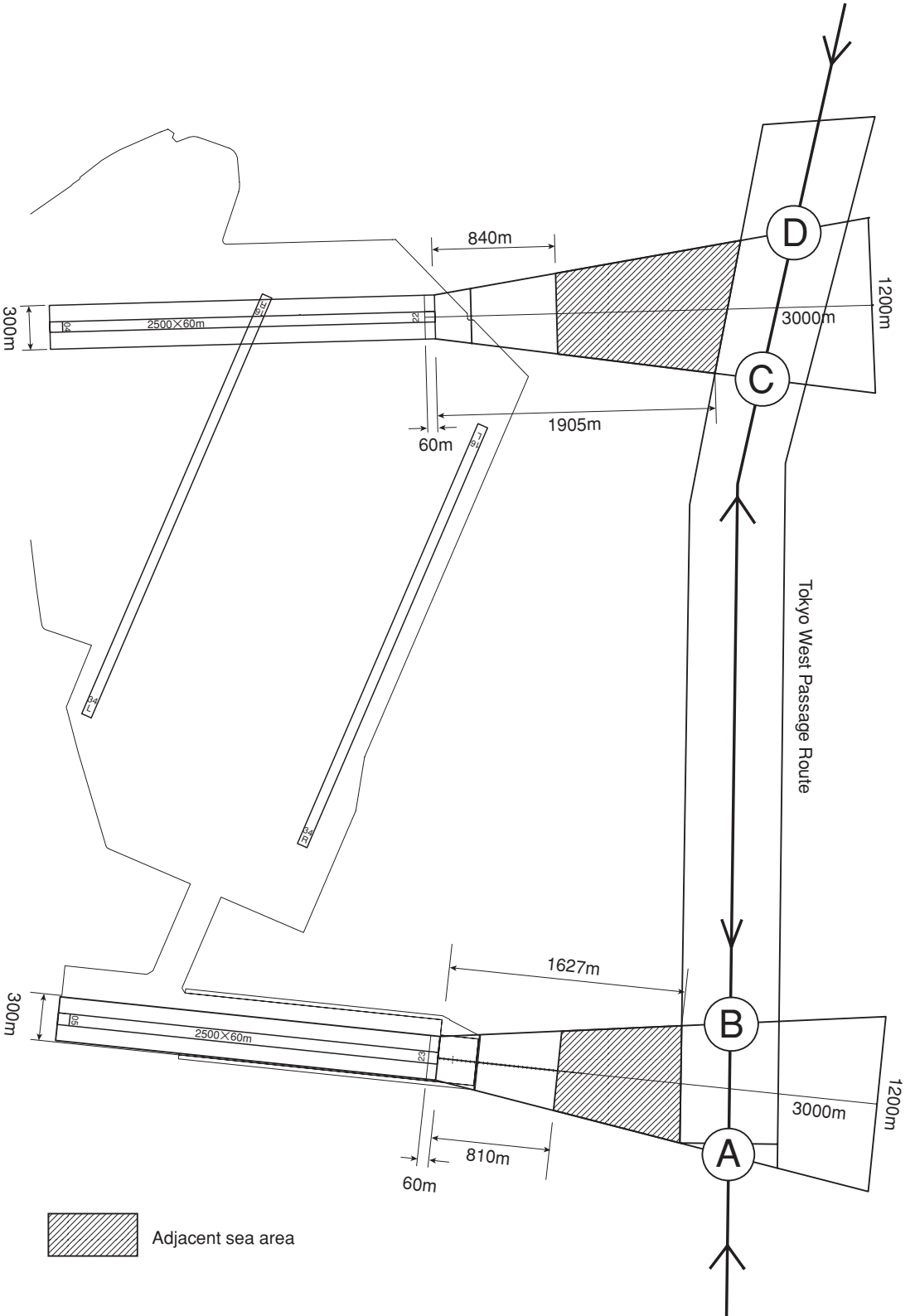



(断面図)

- 航空機の運航に影響がある高さの船舶：  
側傍海域にあつては、N.H.H.W.L + 24.0m以上の船舶
- 東京西航路にあつては、N.H.H.W.L + 56.3m以上の船舶
- N.H.H.W.L：満潮時でこれより高くならないと想定される潮位

(profile view)

- The Vessel height which affects aircraft operations adjacent sea area：  
Vessel height is at or above N.H.H.W.L + 24.0m
- Tokyo West Passage Route：  
Vessel height is at or above N.H.H.W.L + 56.3m
- N.H.H.W.L: Nearly Highest High Water Level

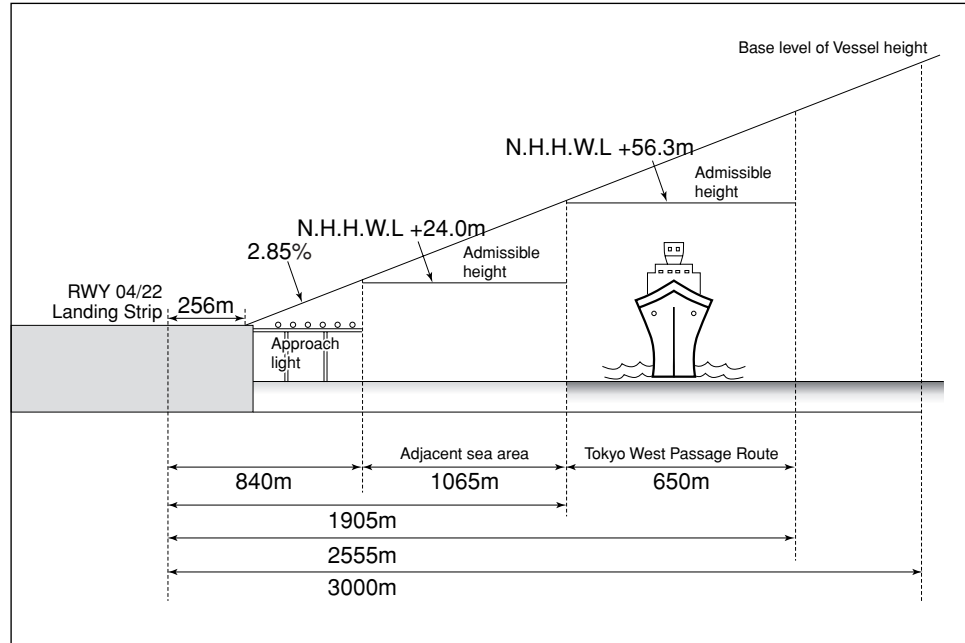

(断面図)

- 航空機の運航に影響がある高さの船舶：  
側傍海域にあつては、N.H.H.W.L + 28.4m以上の船舶
- 東京西航路にあつては、N.H.H.W.L + 53.7m以上の船舶
- N.H.H.W.L：満潮時でこれより高くならないと想定される潮位

(profile view)

- The Vessel height which affects aircraft operations adjacent sea area：  
Vessel height is at or above N.H.H.W.L + 28.4m
- Tokyo West Passage Route：  
Vessel height is at or above N.H.H.W.L + 53.7m
- N.H.H.W.L: Nearly Highest High Water Level

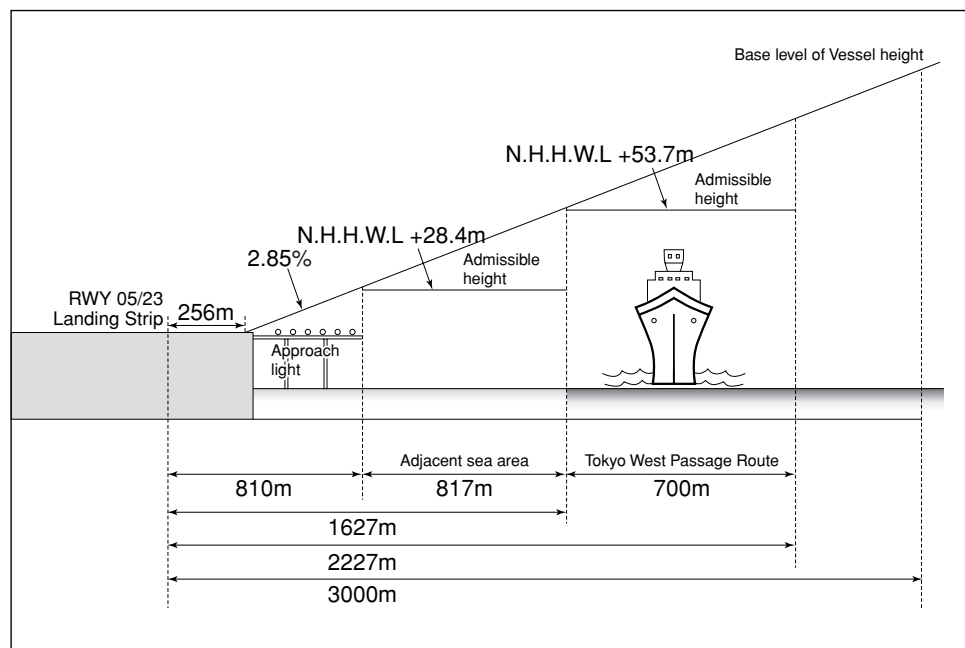

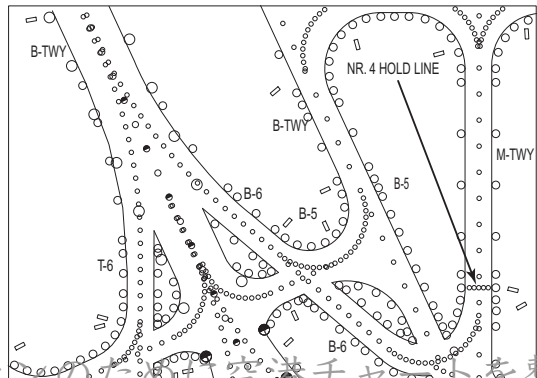
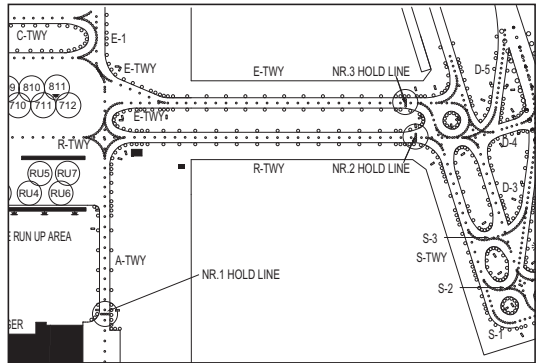
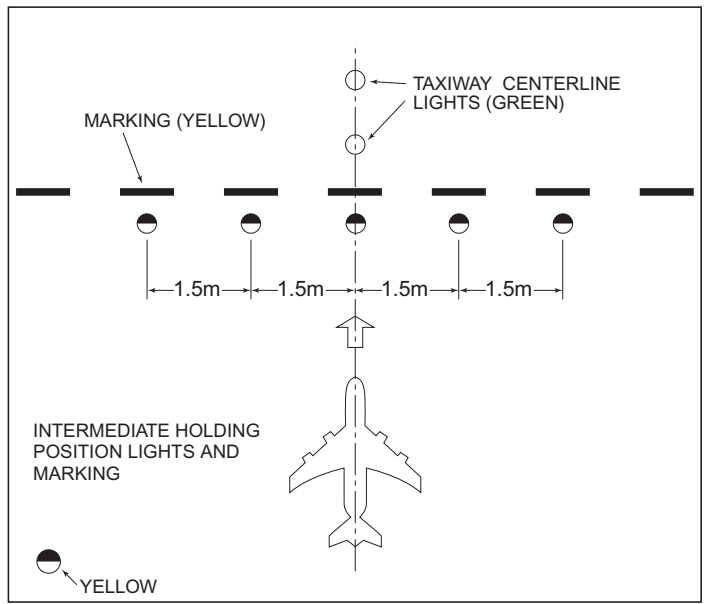

MARKING AIDS

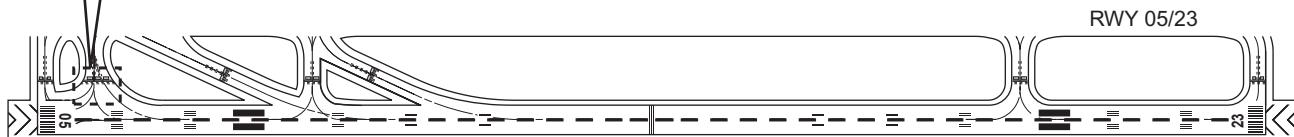
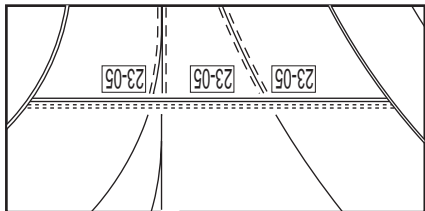
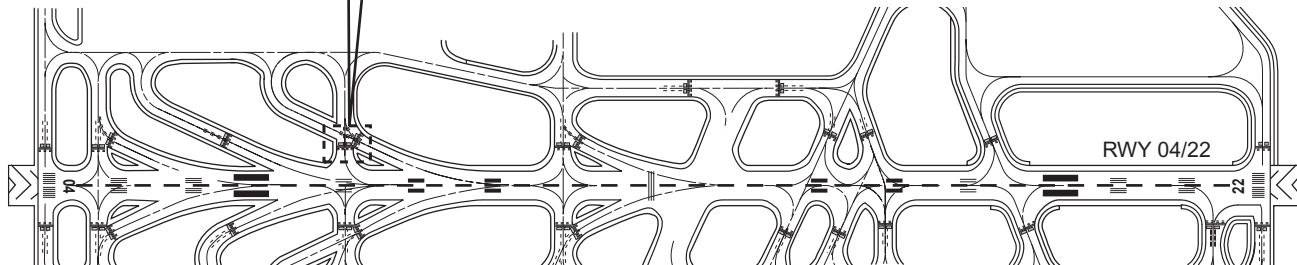
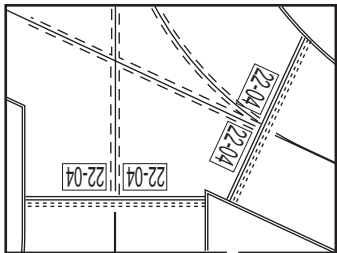

yinlei.orgは航空ファンのために空港チャートを整理しました。

# MARKING AIDS

RWY 16L/34R

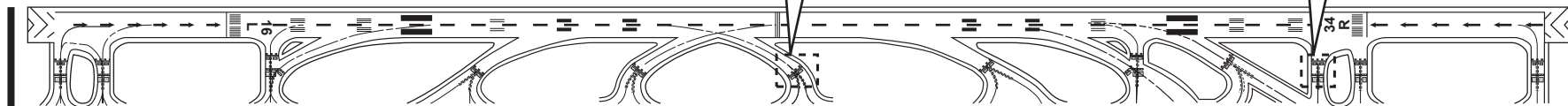
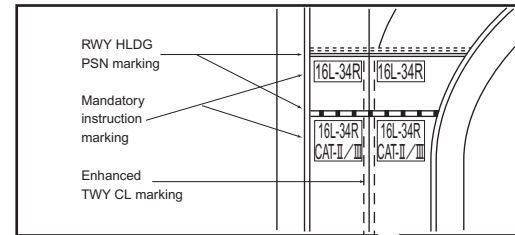
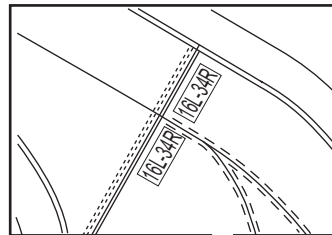

RWY 16R/34L

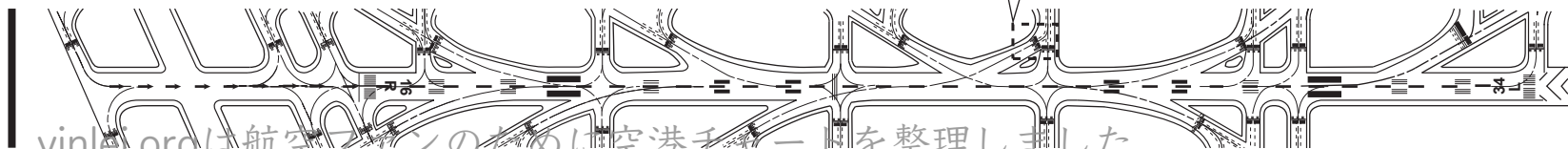
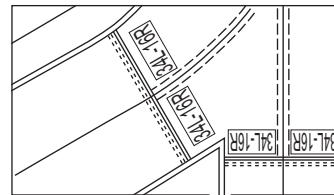

# Type of Surface Painted Markings

## 1. Type of Surface Painted Markings

- Surface Painted Direction Sign

This type of marking at a taxiway intersection indicates the designation and direction of the taxiway leading out of an intersection. Black inscriptions with an arrow with a yellow background.

- Surface Painted Location Sign

This type of marking indicates the designation of the taxiway on which the aircraft is located. Yellow inscriptions with a black background and yellow frame.

## 2. On each of the taxiways A, A14, A15, A16, B, B6, B7, B9, B10, F, H, J, K, L, L13, L15, L16, M, N, N2, N3, N4, N5, T, T7, T9, T11, U2, U4, W, surface painted markings are provided (refer attached drawing).

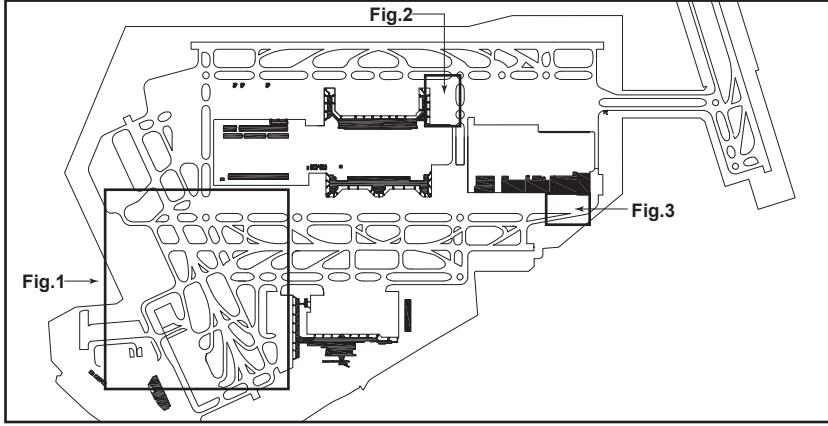

Fig.1

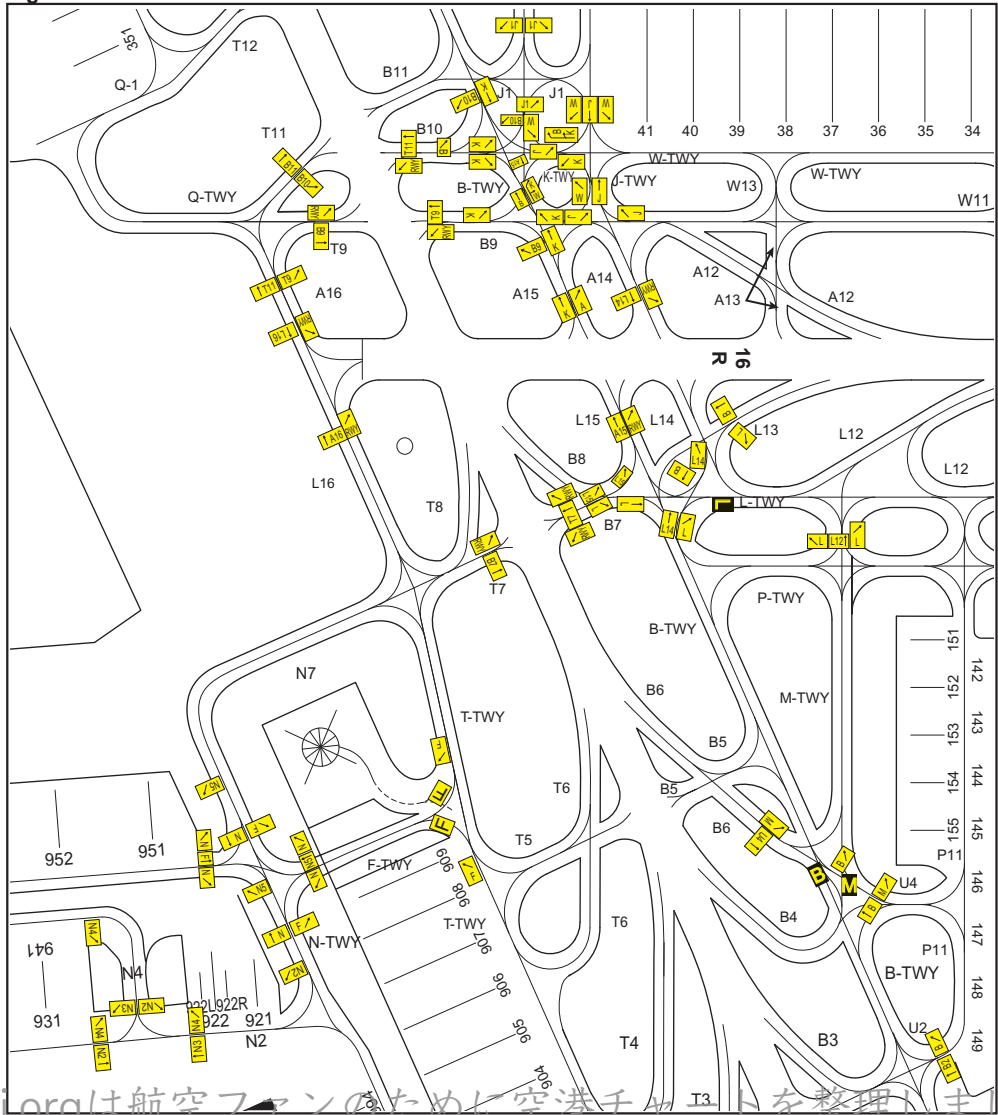

Fig.2

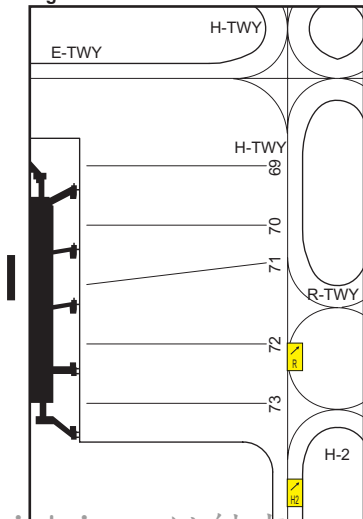
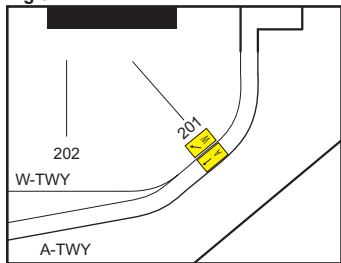
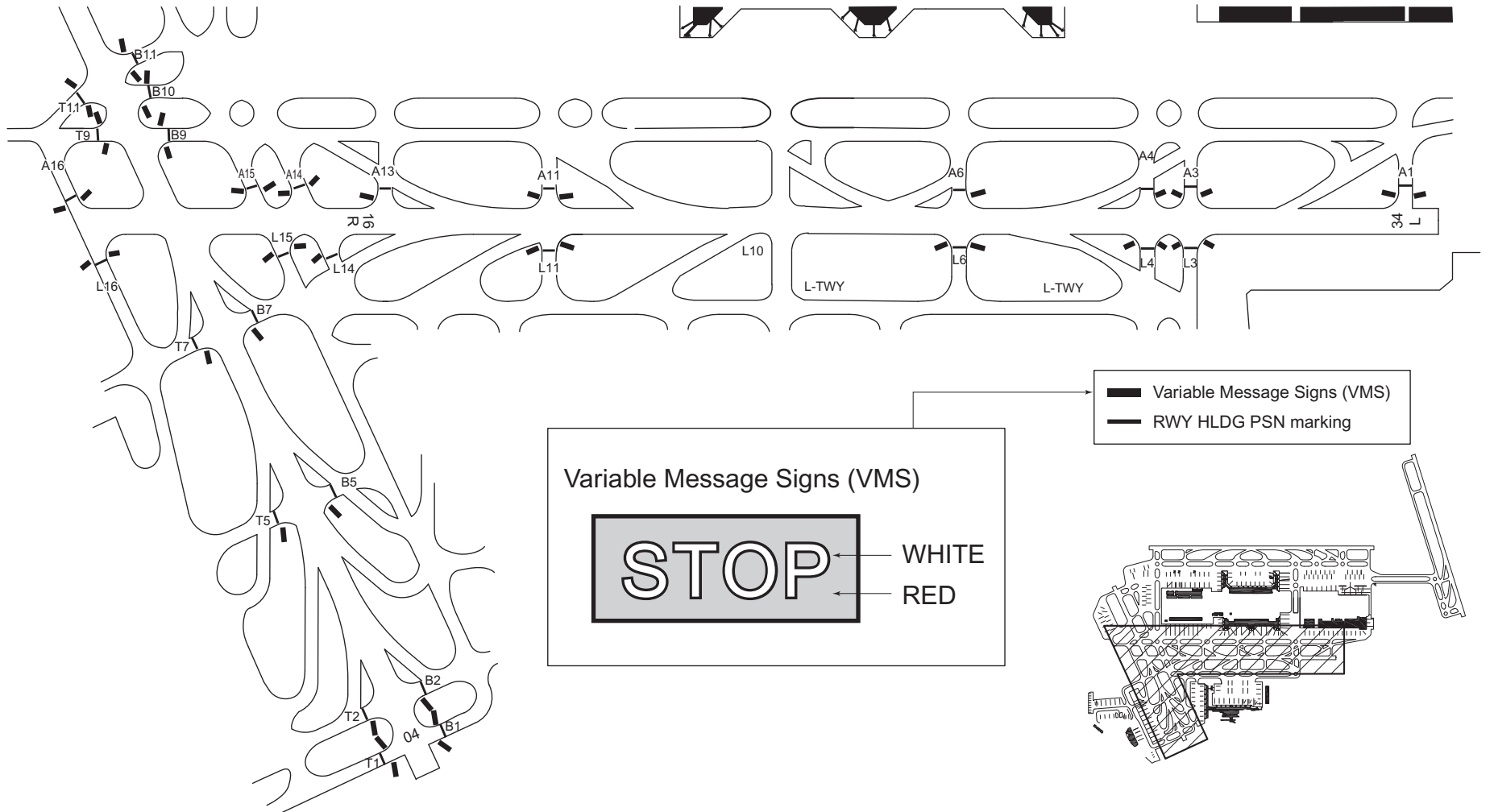

Fig.3



# Variable Message Signs (VMS)

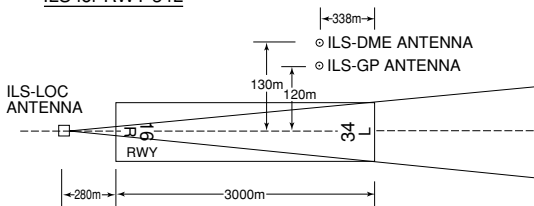

NOTE : The TWY names and RWY HLDG PSN markings in this ATTACHMENT are depicted only for the TWYs where VMS are installed.

ILS for RWY 34L

REMARKS : 1. LOC beam BRG (MAG) 337°  
 2. HGT of ILS REF datum 16.5m(54ft)  
 3. GP Angle 3.0°  
 4. ELEV of ILS-DME 13.0m(43ft)

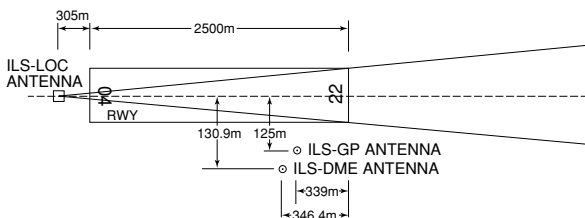
ILS for RWY 22

REMARKS : 1. LOC beam BRG(MAG) 222°  
 2. HGT of ILS REF datum 16.5m(54ft)  
 3. GP Angle 3.0°  
 4. ELEV of ILS-DME 13.5m(44ft)

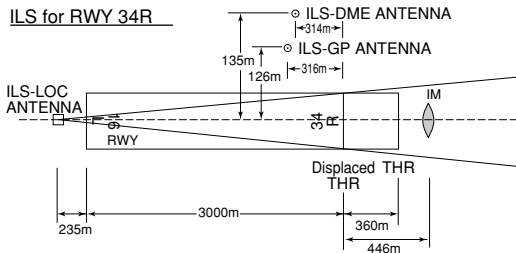
ILS for RWY 34R

REMARKS : 1. LOC BEAM BRG(MAG) 337°  
 2. HGT of ILS REF datum 16.5m(54ft)  
 3. GP Angle 3.0°  
 4. ELEV of ILS-DME 10.6m(35ft)