

## AD 2 AERODROMES

## RJOO AD 2.1 AERODROME LOCATION INDICATOR AND NAME

## RJOO - OSAKA International

## RJOO AD 2.2 AERODROME GEOGRAPHICAL AND ADMINISTRATIVE DATA

1	ARP coordinates and site at AD	344704N/1352621E
2	Direction and distance from (city)	10.5km (5.7nm) NW of JR Osaka station
3	Elevation/ Reference temperature	39ft / 34°C (2004-2008)
4	Geoid undulation at AD ELEV PSN	Nil
5	MAG VAR/ Annual change	7°W (2012) / 1.0°W
6	AD Administration, address, telephone, telefax, telex, AFS, e-mail and/or Web-site addresses	Kansai Airports Osaka International Airport 555, 3-chome, Nishi-machi, Hotarugaike, Toyonakashi, Osaka pref, Japan Tel: 06-4865-9571 Fax: 06-4865-9570 AFS: RJOYDYX E-mail: itm-ops@kansai-airports.co.jp Web-site: http://www.kansai-airports.co.jp/
7	Types of traffic permitted(IFR/VFR)	IFR/VFR
8	Remarks	Osaka Airport Office (CAB) Osaka International Airport 371, 3-chome, Nishi-machi, Hotarugaike, Toyonakashi, Osaka pref, Japan Tel: 06-6843-1121 (2330-0815UTC MON THRU FRI) Tel: 06-6843-1124 (AIS) AFS:RJOYFYX

## RJOO AD 2.3 OPERATIONAL HOURS

1	AD Administration	2200 - 1200
2	Customs and immigration	On request Customs: 06-6576-3104, 06-6576-3123 Immigration: 06-4703-2100
3	Health and sanitation	On request Quarantine(human): 06-6571-4312 Quarantine(animal): 072-455-1956 Quarantine(plant): 06-6571-0801
4	AIS Briefing Office	H24
5	ATS Reporting Office(ARO)	Nil
6	MET Briefing Office	H24 (KANSAI)
7	ATS	2200-1200 (Flight Information Service (except ATIS) and Alerting Service: H24).
8	Fuelling	H24
9	Handling	2100-1330
10	Security	2100-1200
11	De-icing	Nil
12	Remarks	Nil

**RJOO AD 2.4 HANDLING SERVICES AND FACILITIES**

1	Cargo-handling facilities	All the modern institutions that deal with the weight thing to a Boeing 747 type passenger plane.
2	Fuel/ oil types	Fuel grades: JET A-1 Oil grades: All turbine grades
3	Fuelling facilities/ capacity	Hydrant refueling on terminal apron for turbine fuel. Fuel truck refueling. / No limitations
4	De-icing facilities	Nil
5	Hangar space for visiting aircraft	Nil
6	Repair facilities for visiting aircraft	Nil
7	Remarks	Nil

**RJOO AD 2.5 PASSENGER FACILITIES**

1	Hotels	Hotel near the Airport.
2	Restaurants	Available but not continuous 0700-2130 hours
3	Transportation	Monorail, busses and taxis
4	Medical facilities	Toyonaka city hospital
5	Bank and Post Office	Post office at Airport
6	Tourist Office	At Airport
7	Remarks	Nil

**RJOO AD 2.6 RESCUE AND FIRE FIGHTING SERVICES**

1	AD category for fire fighting	CAT 9
2	Rescue equipment	Chemical fire fighting truck x 3, Water supply truck, Emergency medical equipments conveyance truck, Lighting power supply truck
3	Capability for removal of disabled aircraft	Nil
4	Remarks	Nil

**RJOO AD 2.7 SEASONAL AVAILABILITY-CLEARING**

1	Types of clearing equipment	Snow removal equipment: Motor graders
2	Clearance priorities	1) RWY 14R/32L 2) TWY A4, B2, B3, B4, C1, C4, C6, E1, E5, W2, W9, W10, Apron TWY BTN E1 and E5 3) RWY 14L/32R 4) TWY A1, A2, A3, A5, B1, W1, W3
3	Remarks	1) Snow removal will be commenced with the order of priority as item 2, if the runways and taxiways are contaminated with 3 cm depth of snow. 2) Seasonal availability: All seasons Any contaminants on RWY centerline, landing strip and other lighting aids shall be removed as and when necessary so as to provide good contact with RWY.

RJOO AD 2.8 APRONS, TAXIWAYS AND CHECK LOCATIONS DATA

1	Apron surface and strength	Surface : Concrete Strength : PCN62/R/B/X/T : SPOT NR0, 1 PCN52/R/B/X/T : SPOT NR2, 3, 15, 19, 20, 51-53, 77, 80, 83, 84 PCN74/R/B/X/T : SPOT NR4-14, 16 PCN39/R/B/X/T : SPOT NR17, 24, 25 PCN81/R/A/X/T : SPOT NR18 PCN36/R/B/X/T : SPOT NR21, 22 PCN48/R/B/X/T : SPOT NR23, 45, 45W PCN31/R/B/X/T : SPOT NR26, 27, 41-44, 70-76, 81, 82 PCN55/R/B/X/T : SPOT NR46, 47, 48
2	Taxiway width, surface and strength	Width : 30m : W2-W9(Highspeed Exit) 23m : Others Surface : Asphalt Concrete and Concrete Strength : PCN108/F/C/X/T : A1, A2, A3, A4, A5 PCN108/F/A/X/T : B1 PCN142/F/A/X/T : B2 PCN70/F/A/X/T : B3 PCN166/F/A/X/T : B4 PCN113/F/D/X/T : C1 PCN92/F/D/X/T : C2, C4, C6, C7 PCN89/F/C/X/T : C3 PCN71/R/D/X/T : C5 PCN56/R/A/X/T : E1 PCN52/R/B/X/T : E2, W1 PCN62/R/B/X/T : E3, E-INT PCN48/R/B/X/T : E4, E5 PCN52/R/B/X/T : R-INT, R1, R2, R5, R6 PCN92/F/A/X/T : W2 PCN95/F/D/X/T : W3 PCN74/F/C/X/T : W4 PCN89/F/D/X/T : W5,W7 PCN91/F/D/X/T : W6 PCN120/F/C/X/T : W8 PCN91/F/C/X/T : W9 PCN80/F/C/X/T : W10
3	ACL and elevation	Not available
4	VOR checkpoints	Not available
5	INS checkpoints	Spot NR 1 344706.54N 1352640.26E 11 344719.15N 1352629.38E 2 344714.07N 1352647.61E 12 344719.25N 1352626.14E 3 344715.89N 1352645.31E 13 344723.11N 1352628.32E 4 344718.25N 1352642.65E 14 344725.48N 1352625.39E 4A 344717.32N 1352640.49E 15 344724.61N 1352622.77E 4B 344718.21N 1352641.57E 16 344724.68N 1352619.37E 5 344716.57N 1352638.62E 17 344728.66N 1352621.70E 6 344714.28N 1352637.81E 18 344730.96N 1352618.99E 7 344713.53N 1352636.15E 19 344730.50N 1352615.72E 8 344715.05N 1352634.31E 20 344731.56N 1352611.79E 9 344717.64N 1352635.07E 10 344719.95N 1352632.33E 41 344739.21N 1352613.76E 42 344740.12N 1352612.66E 45 344738.84N 1352608.86E 45W 344738.84N 1352609.67E 46 344739.34N 1352609.46E 47 344740.51N 1352610.87E 48 344741.68N 1352612.29E 21 344733.17N 1352613.87E 22 344734.14N 1352615.95E 23 344735.52N 1352618.51E 24 344737.79N 1352619.40E 25 344739.76N 1352618.29E 26 344740.87N 1352616.92E 27 344741.02N 1352615.26E
6	Remarks	Nil

## RJOO AD 2.9 SURFACE MOVEMENT GUIDANCE AND CONTROL SYSTEM AND MARKINGS

1	Use of aircraft stand ID signs, TWY guide lines and Visual docking/ parking guidance system of aircraft stands	ACFT stand ID sign: NR4A, NR4B, NR5 - 10, NR13, NR14, NR17, NR18, NR21 - 23. ACFT stand taxilane: R1, R2, R5, R6, apron TWY at NR1, NR5, NR6 and NR7 Apron Visual docking guidance system: NR13, NR14 (See attachment)
2	RWY and TWY markings and LGT	RWY: RWY 14R/32L (Marking): RWY designation, RWY CL, RWY THR, Aiming point, TDZ, RWY side stripe, RWY middle point (LGT): RCLL, REDL, RTHL, RENL, RTZL(RWY32L), WBAR(RWY32L), RWY DIST marker LGT RWY: RWY 14L/32R (Marking): RWY designation, RWY CL, RWY THR, Aiming point, TDZ, RWY side stripe, RWY middle point (LGT): RCLL, REDL, RTHL, RENL, Takeoff Hold LGT(RWY status LGT) (see attached chart), RWY DIST marker LGT TWY: ALL TWY (Marking): TWY CL, TWY side stripe (LGT): Taxiway edge LGT, Taxiway CL LGT  TWY: TWY B4, C1 THRU C7, W1 THRU W10 (Marking): RWY HLDG PSN (LGT): RWY guard LGT  TWY: TWY A1, B1 (Marking): Intermediate HLDG PSN (LGT): Intermediate HLDG PSN LGT  TWY: TWY W2 (LGT): Stop aiming LGT  SFC painted direction sign and SFC painted LCA sign (See attached chart)  TWY: TWY B4, C1, C6, C7, W6 THRU W10 (LGT): RWY Entrance LGT (RWY status LGT) (see attached chart)
3	Stop bars	Nil
4	Remarks	(Marking) Overrun area (LGT) APN flood LGT

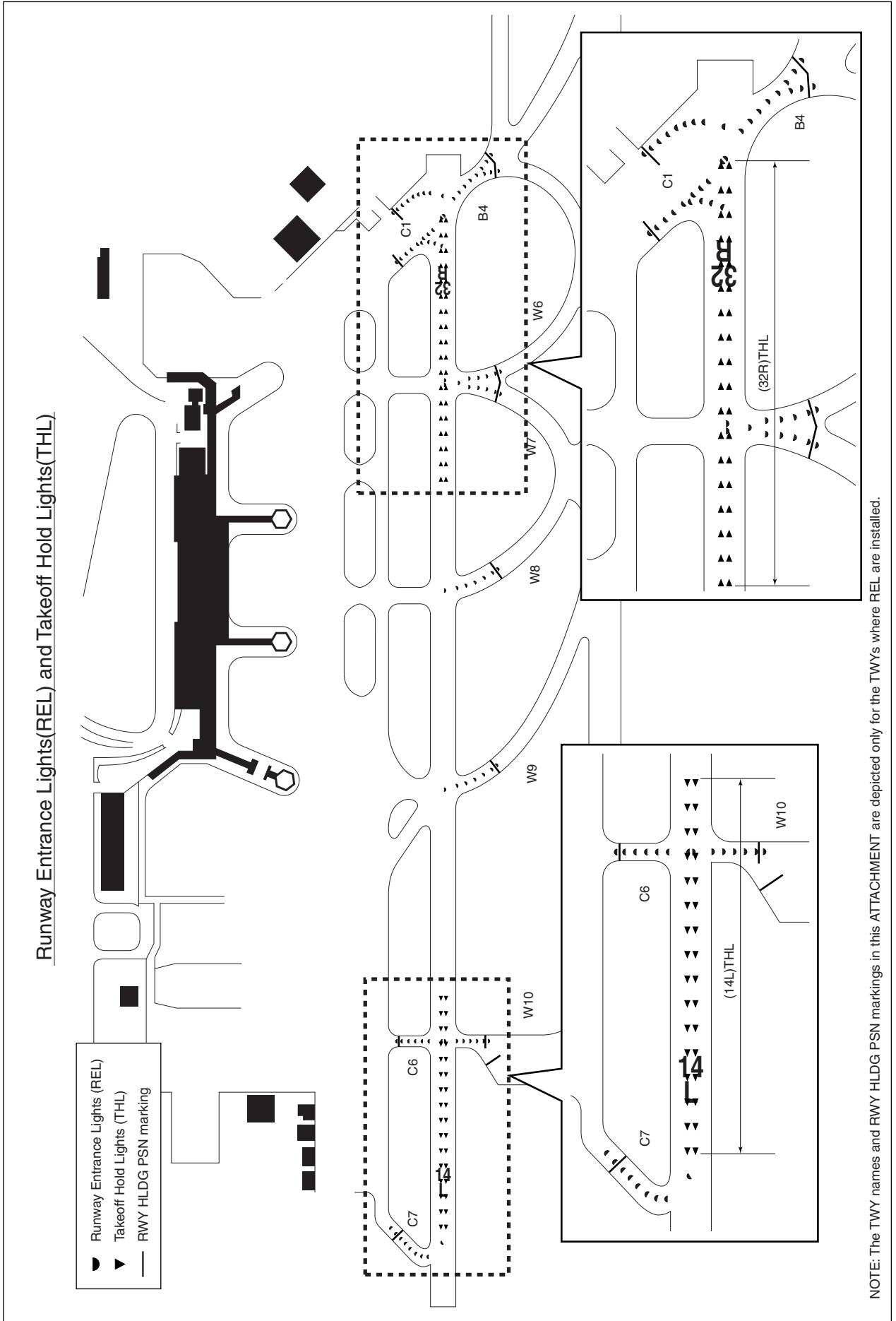

**AIRCRAFT STAND TAXILANE AND PARKING AREAS**

R1, R2, R5, R6, apron TWY at Apron NR5, NR6, and NR7 :Aircraft stand taxilane  
 Spots 45, 45W, 46, 47, 48, 51 to 53 and Apron NR7 and NR8 :Parking areas  
 R-INT. and E-INT. :Intersections

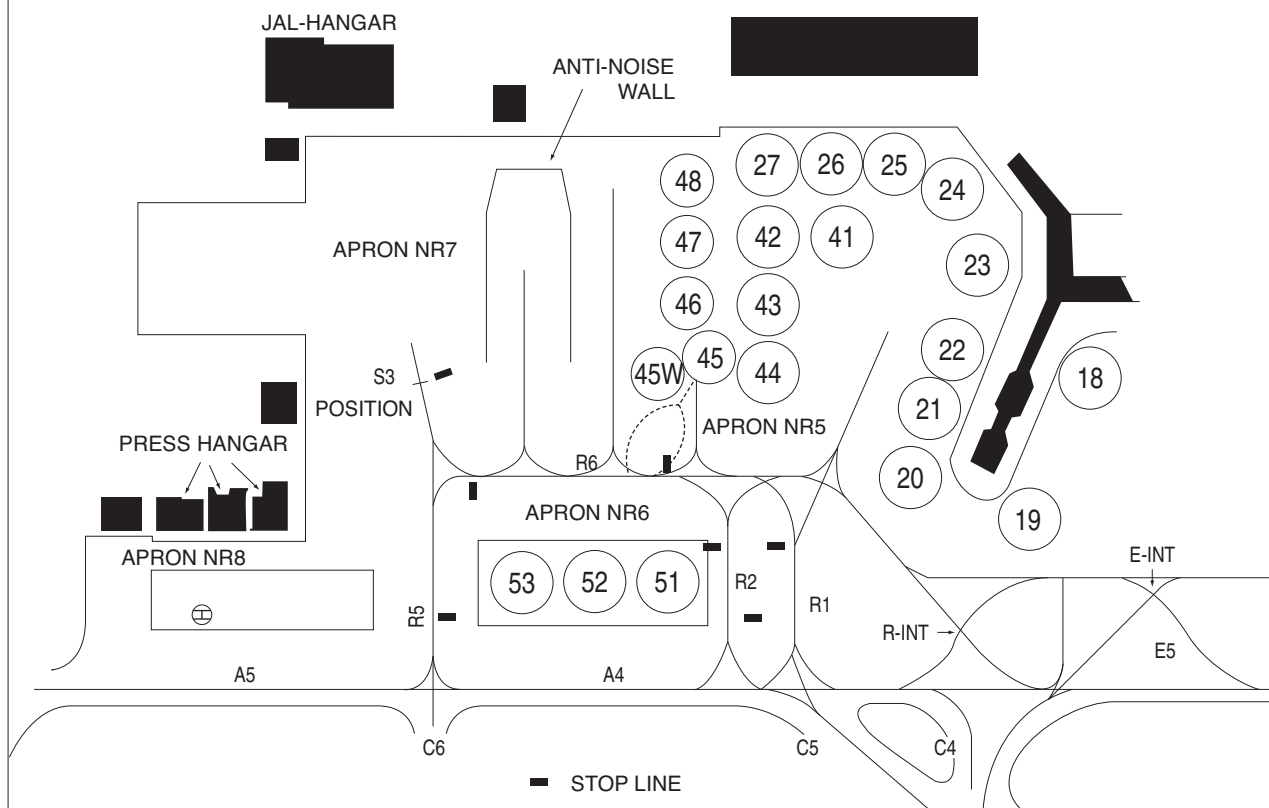

## Surface Painted Direction Sign and Surface Painted Location Sign

### Type of Surface Painted Markings

#### 1.Type of Surface Painted Markings

##### Surface Painted Direction Sign

This type of marking at a taxiway intersection indicates the designation and direction of taxiway leading out of intersection.

Black inscriptions with an arrow with a yellow background.

2.On each of the Taxiway A3, A4, C4, behind APRON NR4, beside SPOT20, R1,R6,W9 and APRON Taxiway between SPOT43 and SPOT44 surface painted markings are provided (refer attached drawing).

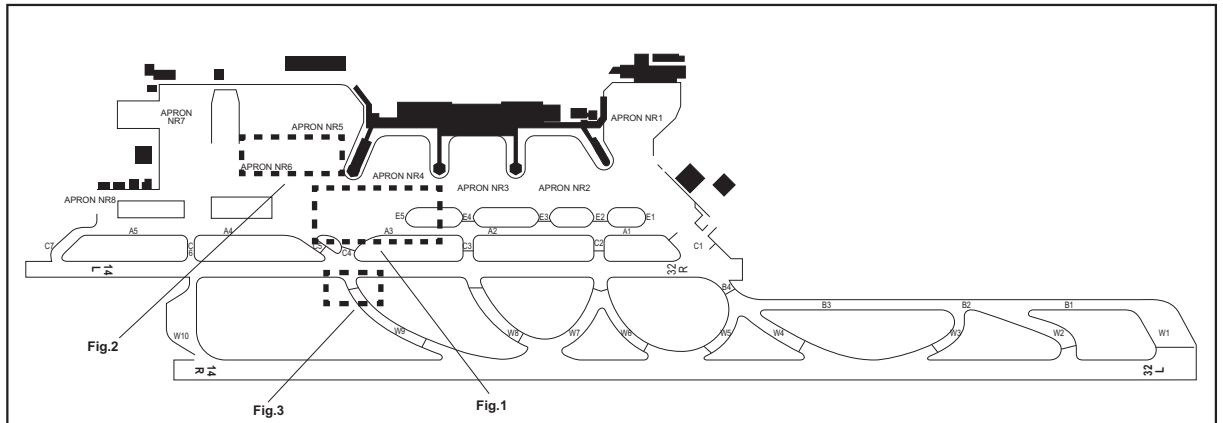

Fig.1

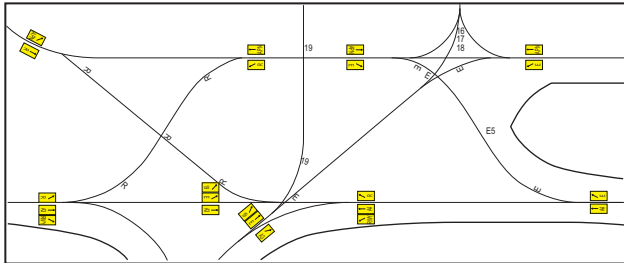

Fig.3

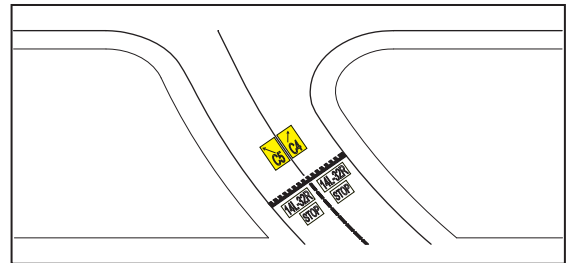
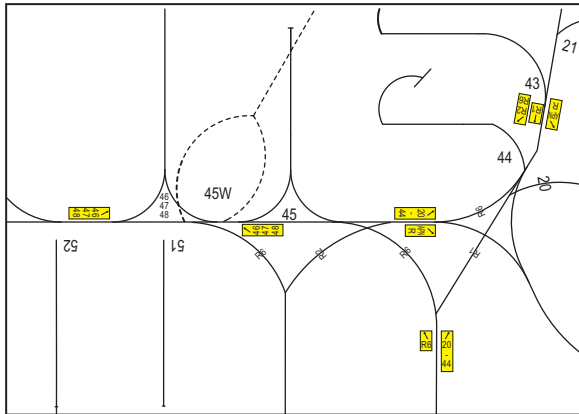

Fig.2



## VISUAL DOCKING GUIDANCE SYSTEM

### 1. General

- (1) Aircraft parking stands NR13, NR14, are equipped with a visual docking guidance system. The pilots of an arriving aircraft assigned to park at one of these parking stands can use this system to be guided and stop the aircraft at the correct parking position.
- (2) This system is operational only in the automatic mode and in an event of a system failure, the aircraft shall be manually guided by a marshaller to the stopping position.
- (3) The visual docking guidance system consists of a display screen for pilots and a laser scanner. The system detects and analyses the aircraft type of an approaching aircraft, tracks it through the laser scanner, and displays these results on the display screen.
- (4) The display screen indicates the following information:
  - a) type of the approaching aircraft
  - b) deviation from the lead-in center line
  - c) distance to the stopping position
 The above information is provided equally to the pilots on both left seat and right seat.

### 2. Aircraft Type Indication

- (1) An operator on ground shall input the aircraft type into the system before the aircraft approaches the parking stand. Upon accepting the input, the system carries out internal calibration, starts the laser scanner simultaneously, and indicates the aircraft type according to the input. The system then will begin to indicate yellow lead-in arrows scrolling upwards prompting the aircraft to proceed. (Fig.1, Fig.2)

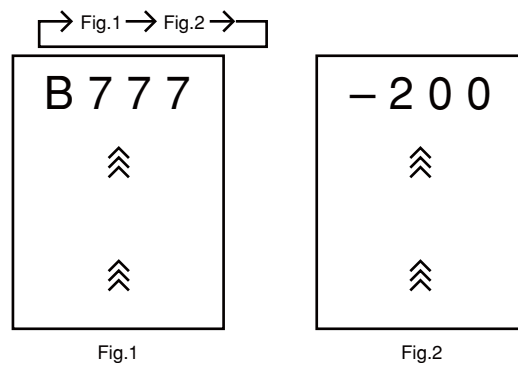

- (2) When the laser scanner detects the approaching aircraft, the display screen will indicate the aircraft type, a "T" bar, and a lead-in upward arrow in yellow.
- (3) At least until the approaching aircraft arrives at a point 15 meters before the stopping position, the system will identify the aircraft type and will compare with the previously input aircraft type. If these data match, the system will continue its operation. If they do not match, the display screen will indicate "STOP" with a red border, and "ID FAIL" simultaneously. (Fig.3)

NOTE: At this moment, the pilots must stop the aircraft immediately.  
When the operator re-input the correct aircraft type into the system and the system finds it correct, it resumes normal operations indicating the correct aircraft type on its display screen.

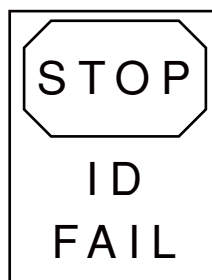

Fig.3



3. Taxiing and Lateral Center line Guidance

- (1) While taxiing the aircraft using the system, the pilots should maneuver the aircraft at a low speed to the stopping position. In an event when "SLOW" is indicated on the display screen, the pilots should further decelerate the taxiing speed to avoid overshooting. (Fig.4)

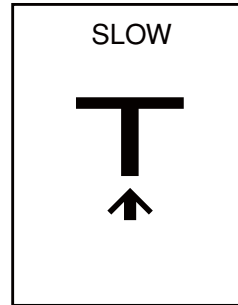

Fig.4

- (2) Deviation of an upward yellow arrow from the center line of "T" indicates the deviation of the approaching aircraft relative to the center line of the parking stand either to right or left. Further, an additional flashing red arrow on the either side indicates the required direction for the aircraft to turn (Fig.5, Fig.6) and indicate numerical value of remaining distance. (Fig.7, Fig.8)

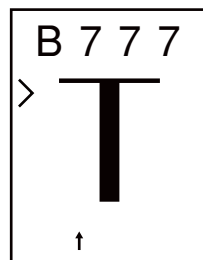

Fig.5

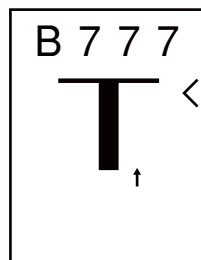

Fig.6

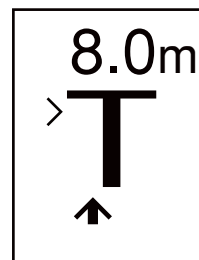

Fig.7

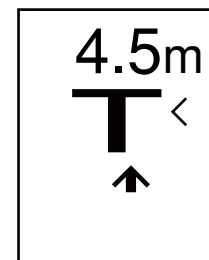

Fig.8

4. Stop Guidance

- (1) When the approaching aircraft is within 20 meters from the stopping position, the shaft of the illuminated "T" will start to reduce in its length from the bottom to indicate the approaching rate of the aircraft, indicating the remaining distance to the stopping position successively. (Fig.9, Fig.10) As the aircraft approaches the stopping position, the shaft of the illuminated "T" retract one row for every 0.3 m.

At aircraft parking stands when the approaching aircraft is within 30 meters from the stopping position, display of digital countdown will start.

As the aircraft approaches the stopping position, a digital countdown shows the distance to stop position numerically, for every 1.0 meters (from 30 to 5 meters to the stop position), for every 0.5 meters (from 5 to 2 meters to the stop position) or for every 0.1 meters (from 2 to 0 meters to the stop position).

When the approaching aircraft is within 20 meter from the stopping position, the shaft of the illuminated "T" will start to reduce in its length from the bottom to indicate the approaching rate of the aircraft, indicating the remaining distance to the stopping position successively. (Fig.11, Fig.12)

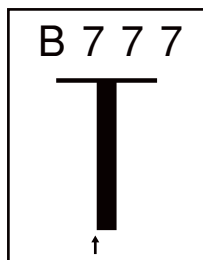

Fig.9

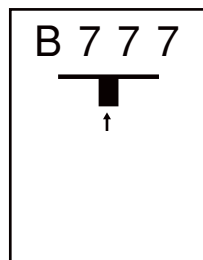

Fig.10

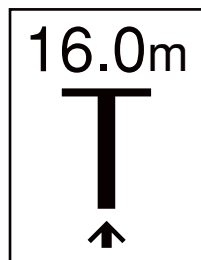

Fig.11

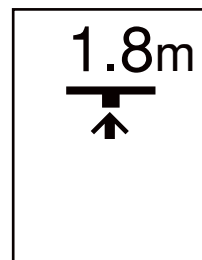

Fig.12

- (2) When the aircraft reaches the stopping position, a message "STOP" will be displayed on the screen with a red border. (Fig.13)

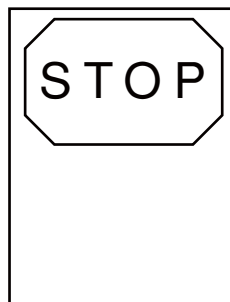

Fig.13

- (3) When the aircraft is stopped at the correct stopping position, a message "OK" will be displayed on the screen in several seconds. (Fig.14)

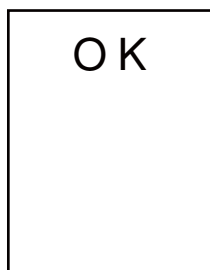

Fig.14

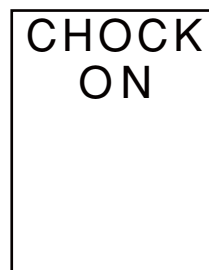

Fig.15

- (4) When the operator applies chocks, and switches on "CHOCK ON" switch, the display screen will display "CHOCK ON." (Fig.15)

- (5) If the aircraft stops at a position beyond the correct stopping position, a message "TOO FAR" will be displayed on the screen. (Fig.16)

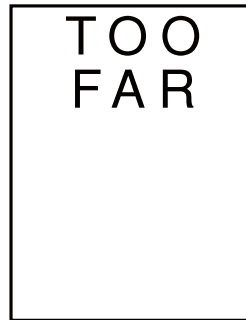

Fig.16

#### 5. Cautions and Safety

- (1) When the system displays an incorrect aircraft type, or when such a message as "STOP", "ID FAIL", or "WAIT" appears on the display screen, the pilots should stop the aircraft immediately. (Fig.3, Fig.13, Fig.17)

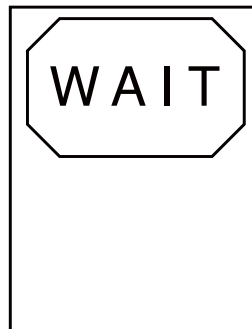

Fig.17

- (2) During heavy fog, rain or snow the visibility for the docking system can be reduced. When the system is activated and in capture mode, the display will deactivate the floating arrows and show "SLOW" (Fig.18). The message will be superseded by the closing rate bar as soon as the system detects the approaching aircraft. The pilot must not proceed beyond the bridge, unless the "SLOW" text has been superseded by the closing rate bar.

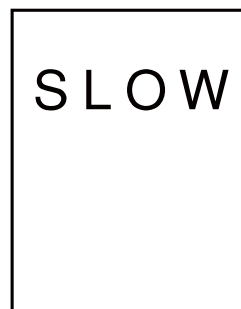

Fig.18

**RJOO AD 2.10 AERODROME OBSTACLES**

RWY/Area affected	Obstacle type	Coordinates	Elevation	Markings/ LGT	Remarks
See AD2.24 Aerodrome Obstacle Chart					

**RJOO AD 2.11 METEOROLOGICAL INFORMATION PROVIDED**

1	Associated MET Office	KANSAI
2	Hours of service MET Office outside hours	H24 (KANSAI)
3	Office responsible for TAF preparation Periods of validity	KANSAI 30 Hours
4	Trend forecast Interval of issuance	Nil
5	Briefing/ consultation provided	Briefing is available upon inquiry at KANSAI
6	Flight documentation Language(s) used	C En
7	Charts and other information available for briefing or consultation	S <sub>6</sub> , U <sub>85</sub> , U <sub>7</sub> , U <sub>5</sub> , U <sub>3</sub> , U <sub>25</sub> , U <sub>2</sub> /T <sub>r</sub> , P <sub>S</sub> , P <sub>5</sub> , P <sub>3</sub> , P <sub>25</sub> , P <sub>SWE</sub> , P <sub>SWF</sub> , P <sub>SWG</sub> , P <sub>SWI</sub> , P <sub>SWM</sub> , P <sub>SW</sub> (domestic), E, C, W <sub>E</sub> , W <sub>F</sub> , W <sub>G</sub> , W <sub>I</sub> , W, N
8	Supplementary equipment available for providing information	Doppler Radar for Airport Weather (See below chart)
9	ATS units provided with information	TWR, ATIS
10	Additional information (limitation of service, etc.)	Nil

**Airspace for the advisory service concerning low level wind shear**

UPPER LIMIT: 1600ft above FIELD ELEV LEVEL  
 LOWER LIMIT: FIELD ELEV LEVEL

FIELD ELEV 39ft

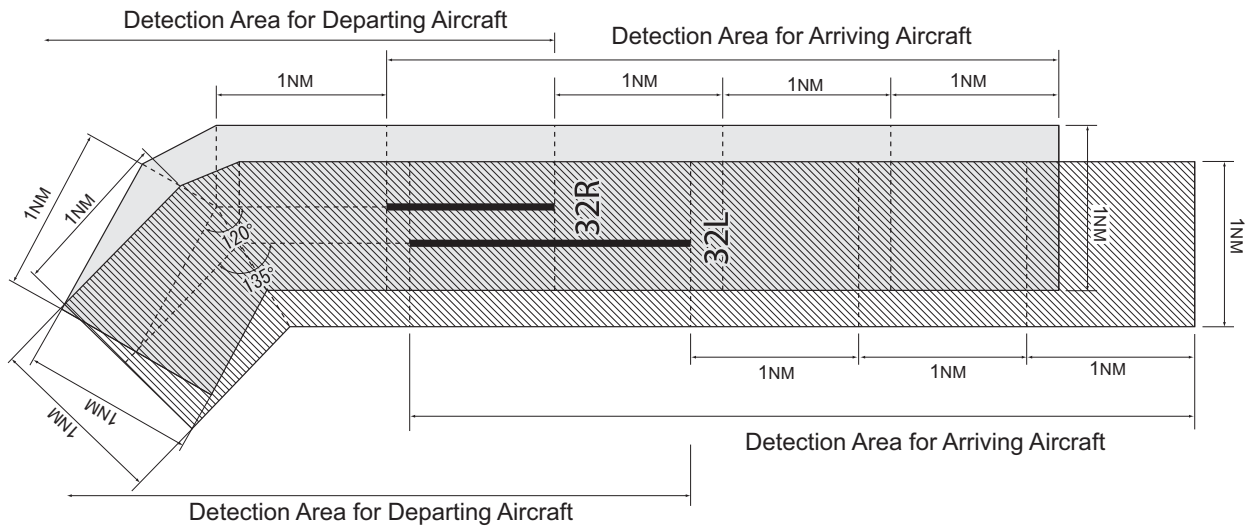
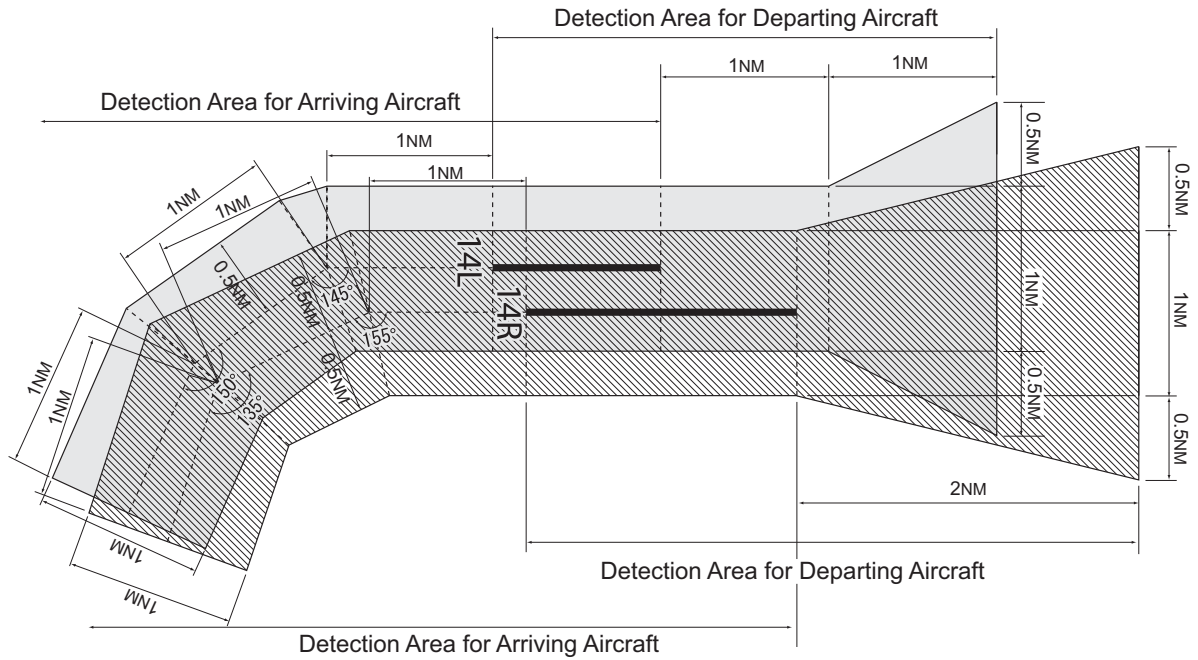

RJOO AD 2.12 RUNWAY PHYSICAL CHARACTERISTICS

Designations RWY NR	TRUE BRG	Dimensions of RWY(M)	Strength(PCN) and surface of RWY	THR coordinates THR geoid undulation	THR elevation and highest elevation of TDZ of precision APP RWY
1	2	3	4	5	6
14R	135°	3000x60	PCN 101/F/C/X/T Asphalt Concrete	344728.77N 1352543.34E	THR ELEV: 46ft
32L	315°	3000x60	PCN 101/F/C/X/T Asphalt Concrete	344619.92N 1352706.76E	THR ELEV: 31.2ft TDZ ELEV: 30.0ft
14L	135°	1828x45	PCN 51/F/C/X/T Asphalt Concrete	344742.97N 1352543.27E	THR ELEV: 50ft
32R	315°	1828x45	PCN 51/F/C/X/T Asphalt Concrete	344701.02N 1352634.11E	THR ELEV: 34ft

Slope of RWY	Strip Dimensions(M)	RESA(Overrun) Dimensions(M)	Remarks
7	10	11	14
See below figure	3120x300	93x(MNM:201 MAX:300)*	RWY grooving: 3000mx40m
	3120x300	140x(MNM:210 MAX:300)*	RWY grooving: 3000mx40m
	1950x150	240x(MNM:137 MAX:150)*	RWY grooving: 1828mx30m
	1950x150	156x(MNM:120 MAX:150)*	RWY grooving: 1828mx30m

\*For detail,  
ask airport administrator

**RJOO AD 2.13 DECLARED DISTANCES**

RWY Designator	TORA (m)	TODA (m)	ASDA (m)	LDA (m)	Remarks
1	2	3	4	5	6
14R	3000	3000	3000	3000	Nil
32L	3000	3000	3000	3000	Nil
14L	1828	1828	1828	1828	Nil
32R	1828	1828	1828	1828	Nil

**RJOO AD 2.14 APPROACH AND RUNWAY LIGHTING**

RWY Designator	APCH LGT type LEN INTST	RTHL Color WBAR	PAPI (VASIS) Angle DIST FM THR MEHT	RTZL LEN	RCLL LEN Spacing Color INTST	REDL LEN Spacing Color INTST	RENL Color WBAR	STWL LEN Color
1	2	3	4	5	6	7	8	9
14R	AGL 422m (*1)	Green	PAPI 3.0°/Left 482m 74ft	Nil	3000m 30m Coded color (White/Red) LIH	3000m 60m Coded color (White/Yellow) LIH	Red	Nil (*3)
32L	PALS (CAT I) 450m LIH	Green Green	PAPI 3.0°/Left 422m 64ft	900m	3000m 30m Coded color (White/Red) LIH	3000m 60m Coded color (White/Yellow) LIH	Red	Nil (*3)
14L	AGL 597m	Green	PAPI 3.0°/Left 383m 61ft	Nil	1828m 30m Coded color (White/Red) LIH	1828m 60m Coded color (White/Yellow) LIH	Red	Nil (*3)
32R	SALS 600m (*2) LIH	Green	PAPI 3.0°/Left 309m 52ft	Nil	1828m 30m Coded color (White/Red) LIH	1828m 60m Coded color (White/Yellow) LIH	Red	Nil (*3)
Remarks								
10								
APCH LGT Beacon(570m and 944m FM RWY 14R THR)(*1) SALS with APCH LGT beacon(980m FM RWY 32R THR)(*2) Overrun area edge LGT(Color:Red)(*3) RWY THR ID LGT for RWY14R/14L THR(Color:White) CGL and RLLS for RWY 14R(see below chart) Usable area of PAPI is shown in below chart								

### Usable area of PAPI

Usable area of PAPI for Runway 14L and Runway 14R is within approximately 2.4NM from Runway 14L threshold and approximately 2.6NM from Runway 14R threshold(Hankyu Railway, Takarazuka Line) due to obstruction (mountain).

滑走路14L末端側及び14R末端側進入角指示灯（PAPI）の使用範囲は、障害物(山)のため滑走路14L末端及び14R末端からそれぞれ2.4NM及び2.6NM（阪急宝塚線）以内とする。

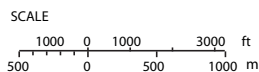



Runway lead-in lighting system for RWY 14 side  
(Nr.1 to Nr.7, Flashing white)

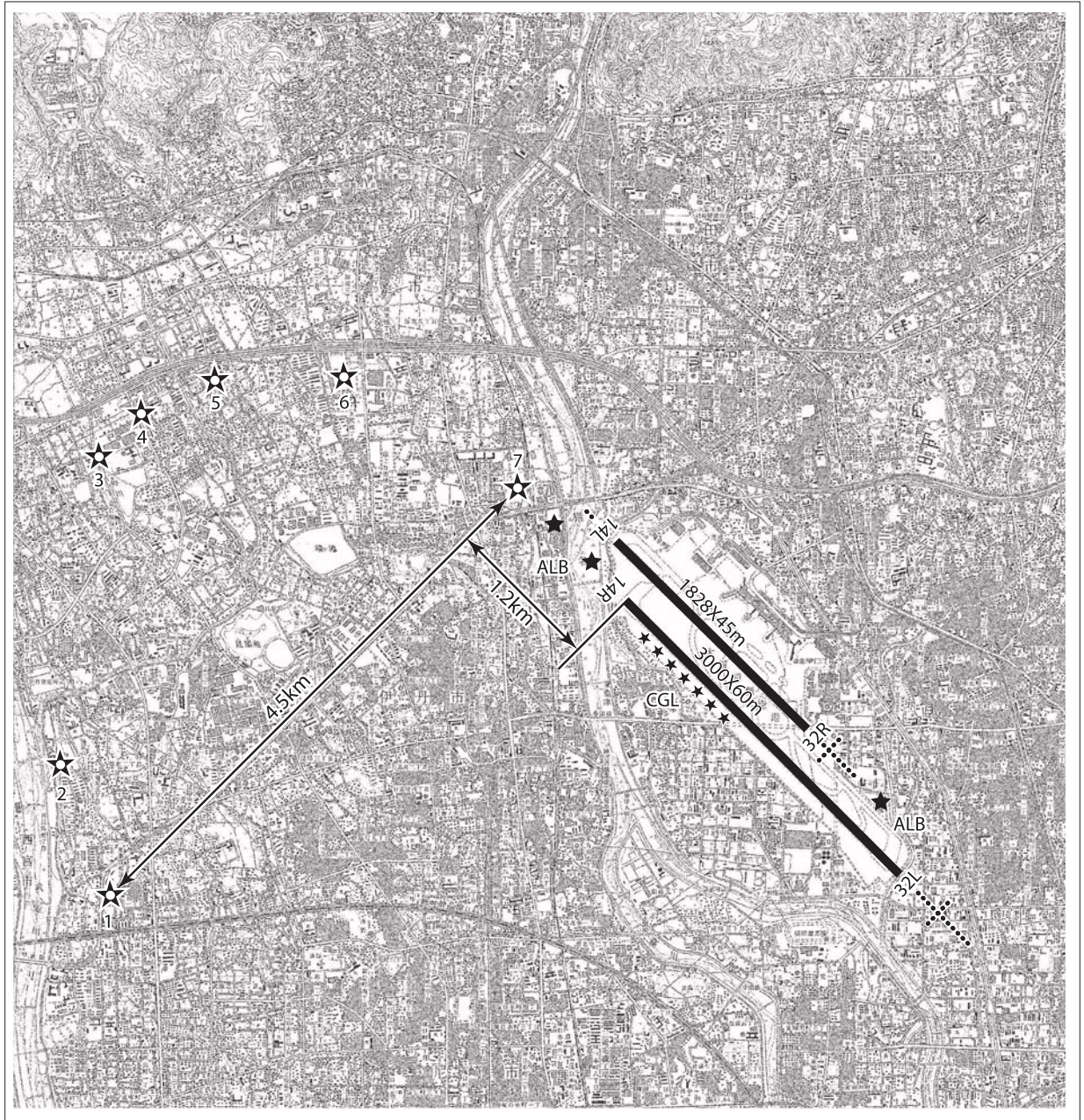

## RJOO AD 2.15 OTHER LIGHTING, SECONDARY POWER SUPPLY

1	ABN/IBN location, characteristics and hours of operation	ABN: 344702N/1352605E, White/Green EV4.3sec, HO
2	LDI location and LGT Anemometer location and LGT	LDI : Nil Anemometer : RWY14R : 231m FM RWY 14R THR, LGTD RWY32L : 558m FM RWY 32L THR, LGTD RWY32R : 60m FM RWY 32R THR, LGTD
3	TWY edge and center line lighting	TWY edge and center line lights installed, see AD2.9
4	Secondary power supply/ switch-over time	Within 1 sec : Runway Entrance LGT, Takeoff Hold LGT Within 15 sec : Other LGT
5	Remarks	Nil

## RJOO AD 2.16 HELICOPTER LANDING AREA

Nil
-----

## RJOO AD 2.17 ATS AIRSPACE

Designation and lateral limits		Vertical limits (ft)	Airspace classification	ATS unit call sign Language	Remarks
1	2	3	4	5	
OSAKA CTR	Area within a radius of 5NM of OSAKA ARP (3447N/13526E )	----- 3000	D	OSAKA TWR En	
OSAKA PCA	1. The airspace bounded by the lines connecting the following points. (1) 344519N/1353203E, (2) 344223N/1352828E, (3) 344038N/1353034E, (4) 344335N/1353409E thence to point(1) The line connecting point(1) to point(2) is the minor arc with a radius of 5NM OSAKA ARP	3000 ----- 700	C	KANSAI APP KANSAI RADAR KANSAI DEP En	See below chart
	2. The airspace bounded by the lines connecting the following points. (4) 344335N/1353409E, (3) 344038N/1353034E, (5) 343953N/1353128E, (6) 344250N/1353504E thence to point(4).	4000 ----- 1100			
	3. The airspace bounded by the lines connecting the following points. (6) 344250N/1353504E, (5) 343953N/1353128E, (7) 343930N/1353157E, (8) 343714N/1353028E, (9) 344005N/1353822E thence to point(6). The line connecting point(8) to point(9) is the minor arc with a radius of 4.5NM of 344112N/1353304E.	5000 ----- 1300 (EXC1300)			
	4. The airspace bounded by the lines connecting the following points. (9) 344005N/1353822E, (8) 343714N/1353028E, (10)343317N/1352752E, (11)343639N/ 1354230E thence to point(9). The line connecting point(9) to point(8) is the minor arc with a radius of 4.5NM of 344112N/1353304E. The line connecting point(10) to point(11) is the minor arc with a radius of 9NM of 344112N/1353304E	5000 ----- 3000			
KANSAI ACA	See RJBB attached chart				
KANSAI TCA	See RJBB attached chart				

Osaka Positive Control Area  
大阪特別管制区

NAME	LATERAL LIMITS	UPPER LIMIT (AMSL) ----- LOWER LIMIT (AMSL) M(ft)	UNIT PROVIDING SERVICE	REMARKS
1	2	3	4	5
Osaka	The area shown on the below figure		Primary: Kansai APP Kansai Radar 124.7-120.45 261.2  Secondary: Osaka Tower 118.1-126.2 236.8	Pilot of aircraft operating in this area shall contact KANSAI APP (RADAR) or OSAKA TWR for ATC instructions giving informations on aircraft identification, position, altitude and pilot's intentions.  当該空港を飛行しようとする航空機は、関西アプローチ（レーダー）又は大阪タワーに連絡し、コールサイン、現在位置、高度及び意図を通報し指示を受けること。

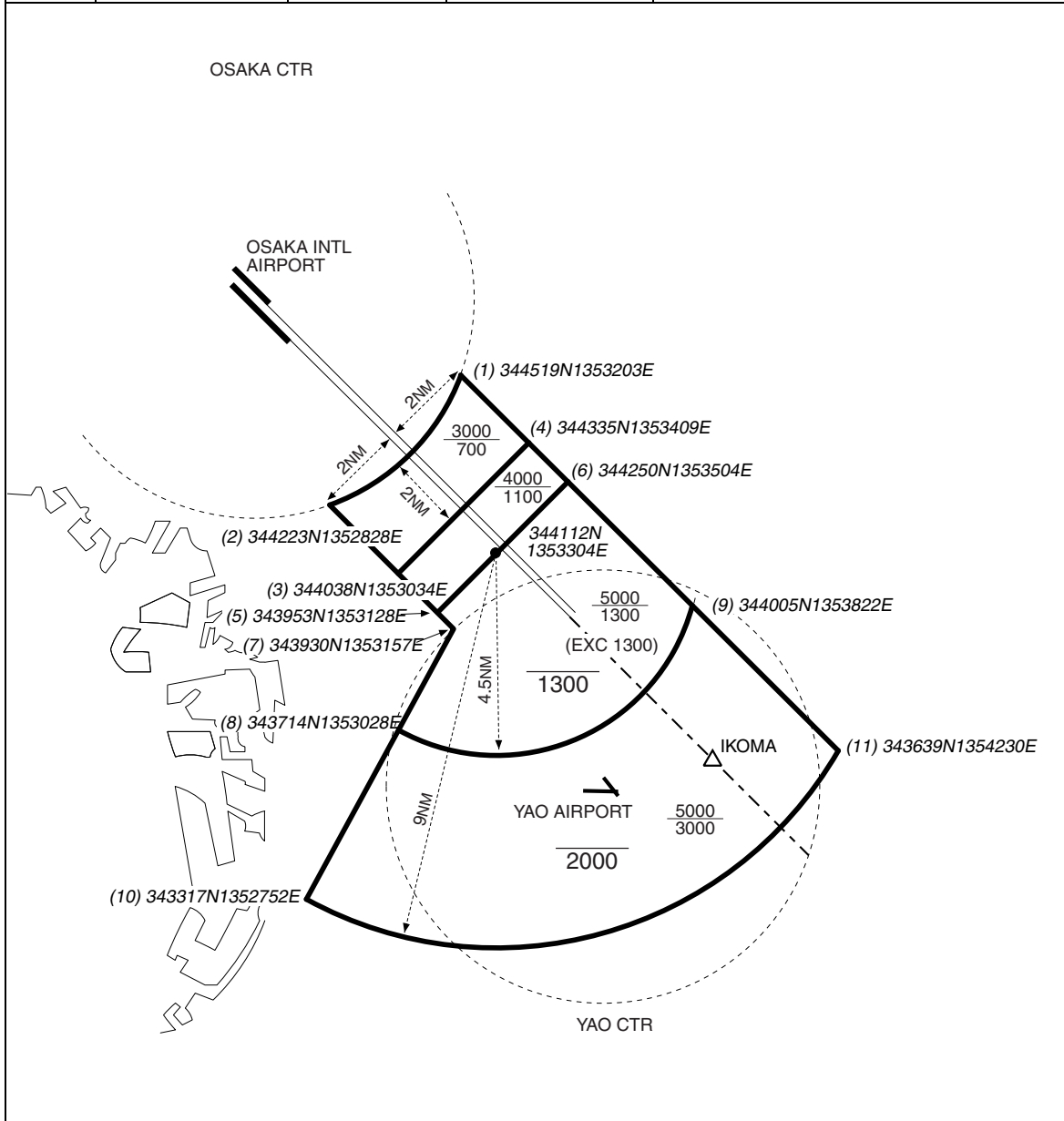

## RJOO AD 2.18 ATS COMMUNICATION FACILITIES

Service designation	Call sign	Frequency	Hours of operation	Remarks
1	2	3	4	5
APP/ASR	Kansai Approach/ Kansai Radar	120.45MHz(1) 124.7MHz 261.2MHz 121.5MHz(E) 243.0MHz(E)	2200 - 1200	(1) Primary APP service provided by KANSAI APP
DEP	Kansai Departure	119.5MHz 121.5MHz(E) 243.0MHz(E)	2200 - 1200	
TWR	Osaka Tower	118.1MHz 126.2MHz 236.8MHz 121.5MHz(E) 243.0MHz(E)	2200 - 1200	
GND	Osaka Ground	121.7MHz 126.2MHz	2200 - 1200	
DLVRY	Osaka Delivery	118.8MHz	2200 - 1200	
ATIS	Osaka INTL Airport	128.6MHz	2200 - 1200	

**RJOO AD 2.19 RADIO NAVIGATION AND LANDING AIDS**

Type of aid (VOR declination)	ID	Frequency	Hours of operation	Position of transmitting antenna coordinates	Elevation of DME transmitting antenna	Remarks
1	2	3	4	5	6	7
VOR (7°W / 2014)	ITE	114.75MHz	H24	344819.74N/1352413.18E		Unusable : 000°-010° beyond 20nm BLW 5000ft. 010°-020° beyond 30nm BLW 5000ft. 020°-030° beyond 20nm BLW 5000ft. 030°-060° beyond 20nm BLW 6000ft. 060°-070° beyond 20nm BLW 5000ft. 240°-260° beyond 20nm BLW 6000ft. 260°-270° beyond 15nm BLW 6000ft. 270°-290° beyond 20nm BLW 6000ft. 290°-310° beyond 30nm BLW 6000ft. 310°-340° beyond 20nm BLW 6000ft. 340°-360° beyond 20nm BLW 5000ft.
DME	ITE	1055MHz (CH-94Y)	H24	344819.74N/1352413.18E	176ft	
ILS-LOC 32L	ISK	110.1MHz	2200-1200	344733.87N/1352537.16E		LOC : 222m(728ft) away FM RWY 14R THR, BRG(MAG)322°
ILS-GP 32L	-	334.4MHz	2200-1200	344624.67N/1352653.99E		GP : 333m(1092ft) inside FM RWY 32L THR, 126m(413ft) W of RCL. HGT of ILS REF datum 16.5m(54ft). Angle 3.0°
ILS-DME32L	ISK	999MHz (CH-38X)	2200-1200	344624.57N/1352653.86E	48ft	DME: 333m(1092ft) inside FM RWY32L THR, 130m(426ft) W of RCL
MSAS		1575.42MHz	H24			Transmitting antennas are satellite based.

ILS for RWY 32L

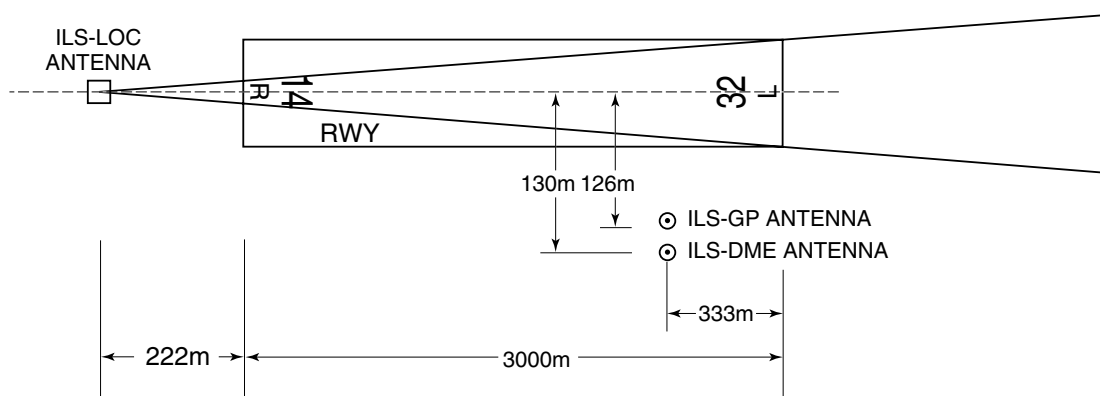

- REMARKS : 1. ILS-LOC beam BRG(MAG) 322°  
 2. HGT of ILS REF datum 16.5m (54 ft)  
 3. ILS-GP Angle 3.0°  
 4. ELEV of ILS-DME 14.6m (48ft)

**RJOO AD 2.20 LOCAL TRAFFIC REGULATIONS**

1. Airport regulations

1. On use of this airport

In order to cope with the increasing flight frequencies and to ensure the safety of flight, the following shall apply to an aircraft operators.

- 1.1 Aircraft other than those of scheduled flights being approved by the Minister of Land, Infrastructure, Transport and Tourism and those which come under the para. 1.2 (a) and (b) below specified are all subject to the prior permission of the Administrator Osaka INTL Airport.
- 1.2 In principle, the use of this airport by light fixed wing aircraft having a maximum take off weight of 5700kg or less shall not be permitted excepting the aircraft underspecified:
  - (a) Aircraft used for operations of:
    - (1) Ministry of Land, Infrastructure, Transport and Tourism
    - (2) Japan Coast Guard,
    - (3) Police Agency,
    - (4) Local Government,
    - (5) Police Department,
    - (6) Fire Department.
  - (b) Aircraft belonging to newspaper offices having their own hanger facilities in this airport, including chartered aircraft.
  - (c) Aircraft which have been registered to use this airport as a home base.
  - (d) Aircraft using this airport with the purpose of aircraft maintainance by the reason that the concerned aircraft operator has now been under the maintenance contract with the maintainance factories located in this airport.

Note: Whenever the flight plan bound for this airport is submitted by the aircraft operator to a airport office or a airport branch office before flight is conducted, the concerned airport authority is urged, prior to its acceptance, to ascertain whether or not the advance approval has been given the operator concerned.

1.3 On the control of flight frequencies

The flight frequency of aircraft is controlled as specified below:

- (a) The total numbers of IFR aircraft permitted to land and to take off are confined to;
  - (1) 36 aircraft for an hour
  - (2) 93 aircraft within 3 hours on a continuous basis
  - (3) 370 aircraft for a day
- (b) The total numbers of IFR aircraft permitted to land are confined to;
  - (1) 20 aircraft an hour
  - (2) 60 aircraft within 3 hours on a continuors basis.

Note:Aircraft in an emergency situations are exempted from applying any of the foregoing limitations.

2. Principal Runway Usage Classification

	Arrival		Departure
RWY 14L/32R	Maximum take-off weight at or less than B737-800 (79,243kg)		Maximum take-off weight at or less than ERJ170 (34,500kg)
RWY 14R/32L	B737-800 B737-700	Other aircraft described left, maximum take-off weight more than B737-800 (79,243kg)	Maximum take-off weight more than ERJ170 (34,500kg)

3. 補助動力装置（APU）の使用制限

航空機が固定電源設備付きのスポットを使用する場合は、管理者が特に認める場合を除き、次に掲げる時間を超えて補助動力装置を使用してはならない。

(1) 出発予定時刻前の 30 分間

(2) 到着後、固定電源設備が使用可能となるまでに必要とする最小限度の時間

(3) 航空機が点検整備のため補助動力装置を必要とする場合は最小限度の時間

注：スポット 4 及び 5 ～ 27 は固定電源設備が設置されている。

3. Restrictions about the use of auxiliary power units(APU)

When an aircraft is using an aircraft parking stand with fixed electric power facilities, APU shall not be used outside the time periods specified below except when specifically acknowledged by the authority as necessary.

(1) 30 minutes prior to the estimated off-block time.

(2) The minimum time required for switching over to the fixed electric power facilities, after arrival at the parking stand.

(3) The minimum time required for aircraft maintenance purposes if needed.

NOTE: Spot 4 and 5-27 are equipped with fixed electric power facilities.

4. ATC Procedure

Call OSAKA DELIVERY 5 minutes prior to starting engines with the following information.

- a) Call sign
- b) Destination
- c) Proposed flight level/altitude (alternative flight levels/altitudes, if any)
- d) Parking position (spot number)

In case that the engines could not be started within 5 minutes after receiving ATC clearance, pilots should notify it to OSAKA DELIVERY.

2. Taxiing to and from stands

Nil

3. Parking area for small aircraft(General aviation)

Nil

4. Parking area for helicopters

Nil

5. Apron - taxiing during winter conditions

Nil

6. Taxiing - limitations

6.1 Safety measures against jet engine blast. (See attachment)

- 1) In case of holding before taking off from RWY 32R, the aircraft which wing span is at or less than 35.79m shall follow the specific taxiway centerline marking installed on TWY C1.
- 2) In order to avoid effect of the blast on RWY 14L, jet aircraft taxiing via TWY W10 are to follow the specific nose-wheel guide line installed on TWY W10 when taking off from RWY 14R.

6.2 Aircraft using TWY C1 and taking off from RWY 32R may be instructed to hold at No.2 stop line illustrated in attachment.

6.3 While operating within aprons, follow strictly yellow nose wheel guide lines.

## Taxiing and Taking off Procedure for RWY 32L

Key to the chart below:

- ① Runway holding position marking on TWY W2
- ② 2700m position from RWY 14R THR
- ③ NO.1 Stop line
- ④ PAPI
- ⑤ TKOF power setting position

\*See the back page for more detailed information.

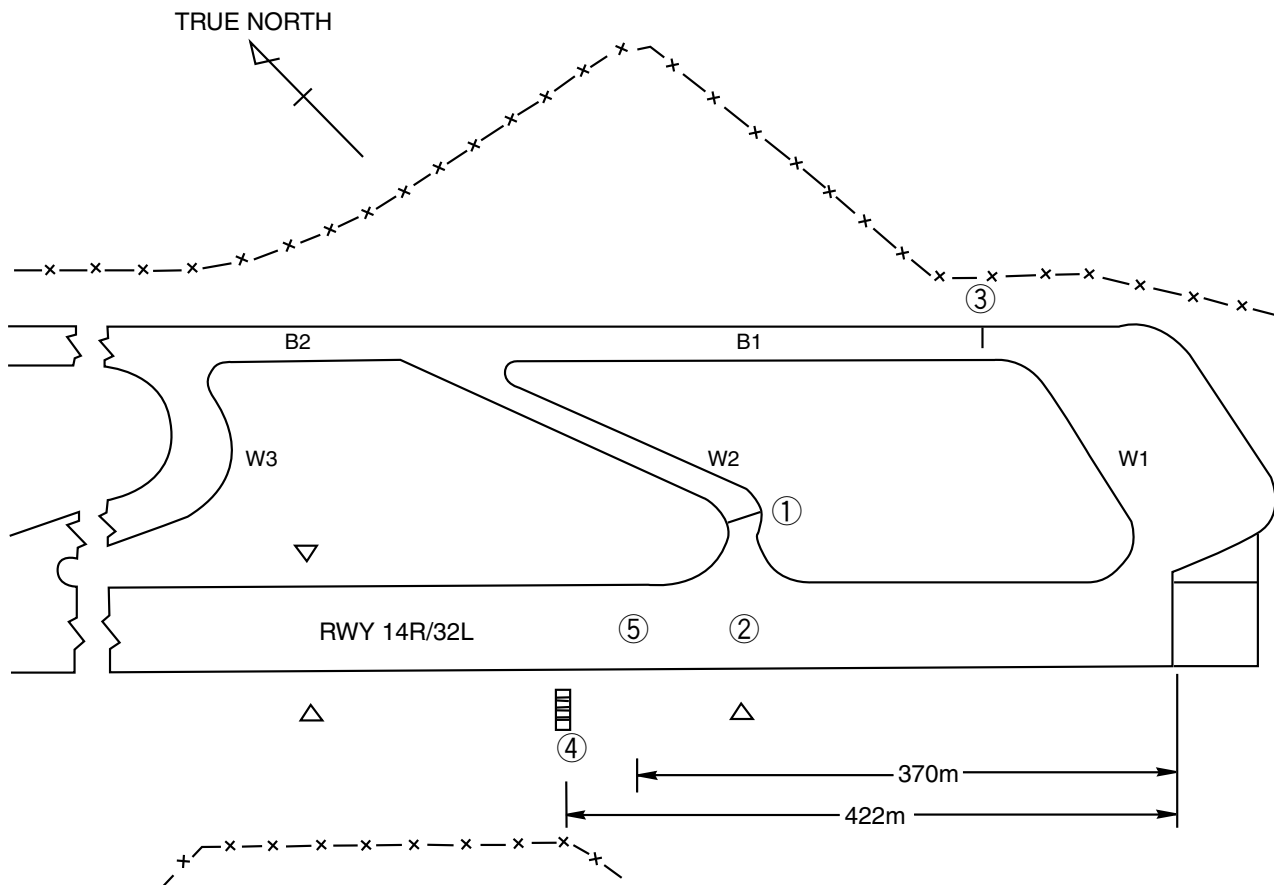



**TAXIING HOLDING POSITION ON TWY W2**

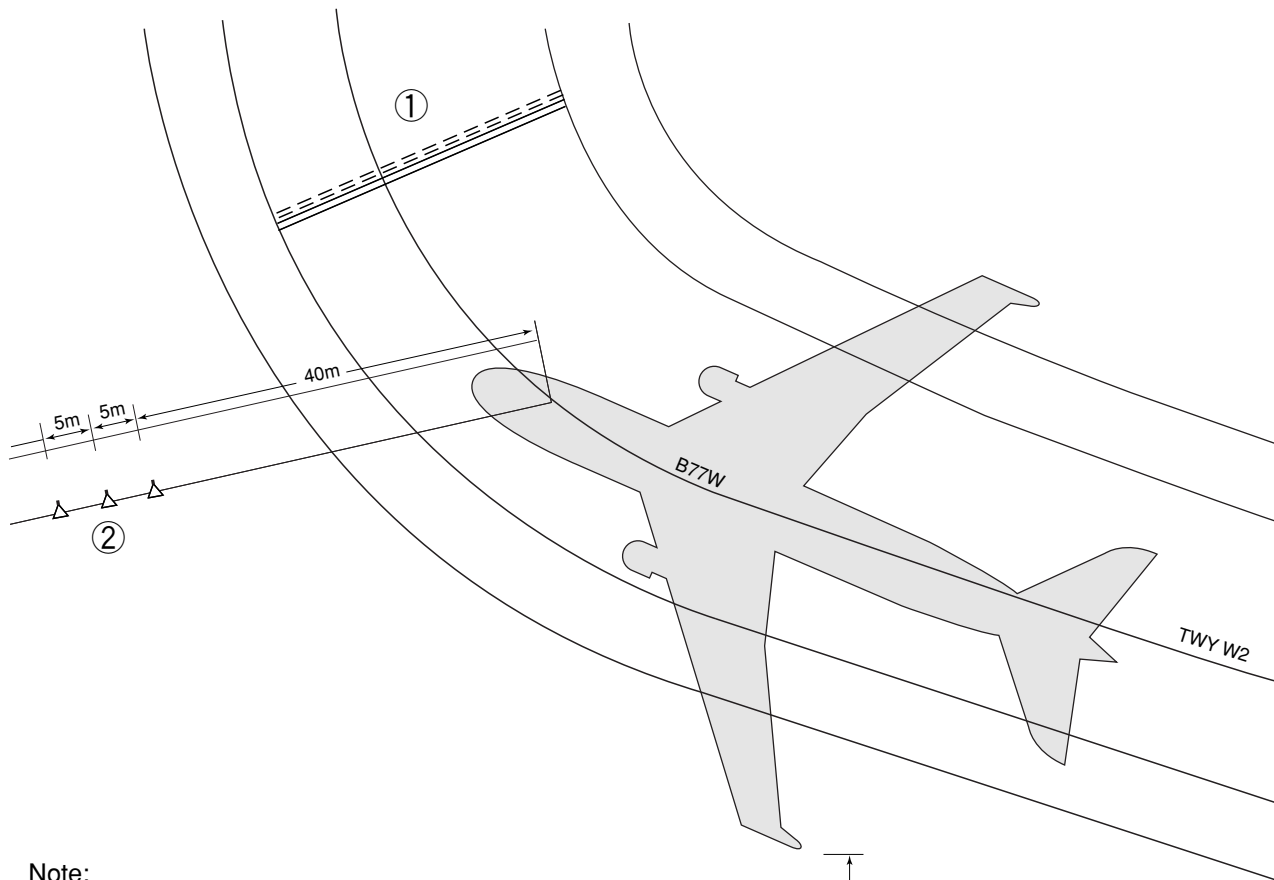

**Note:**  
 When instructed by ATC, aircraft shall hold between runway holding position marking and the line formed by stop aiming lights so as to keep wing tip clearance from aircraft on TWY B1.

15m wing tip clearance

to RWY 32L THR

- Legend:** ① ≡≡≡ Runway holding position marking  
 ② △△△ Stop aiming lights (Type : M-1 Red light)

## Intermediate holding position marking (No.1 Stop line) on Taxiway B

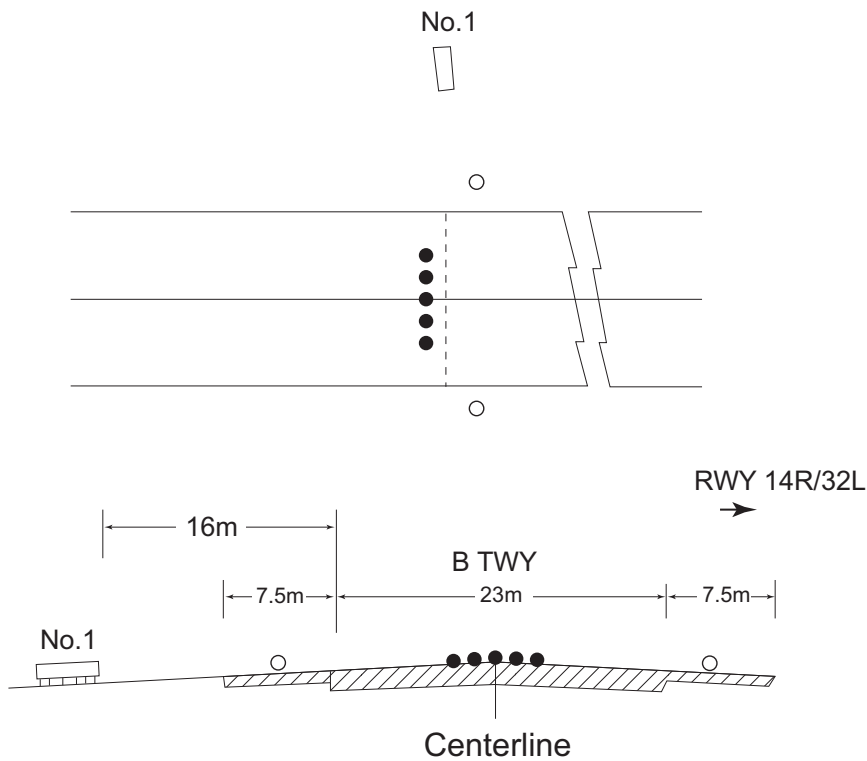

- Legend:
- Intermediate holding position light
  - Taxiway edge light
  - ▭ No.1 Taxiing guidance sign
  - Intermediate holding position marking

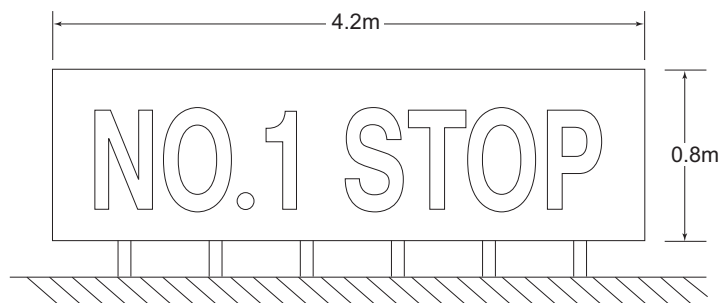

## Intermediate holding position marking (No.2 Stop line) on Taxiway A

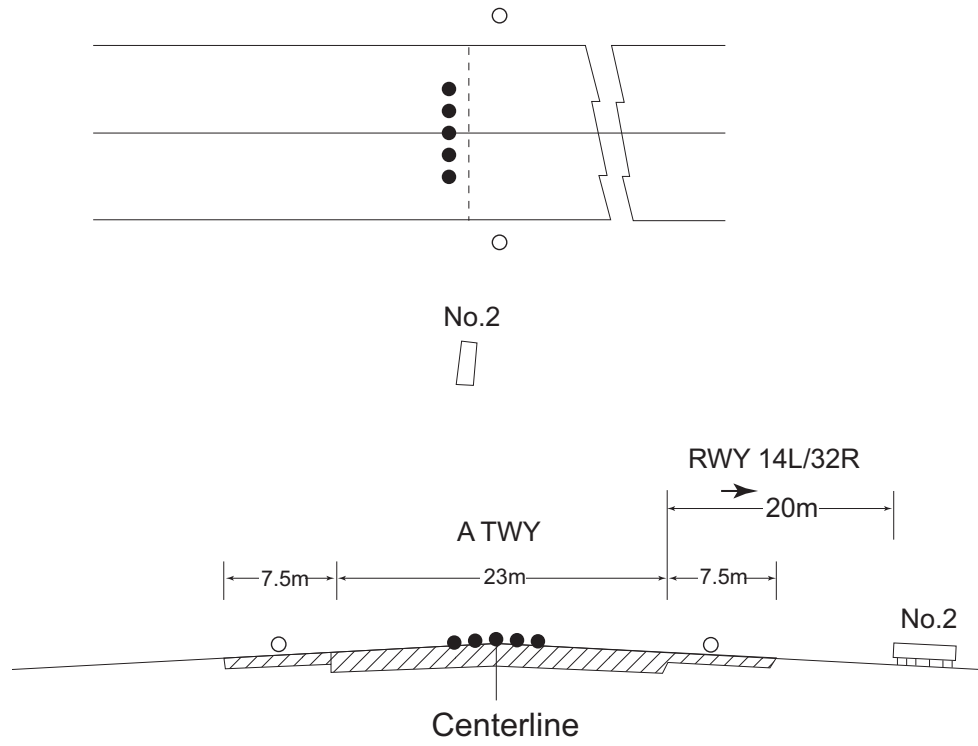

- Legend:
- Intermediate holding position light
  - Taxiway edge light
  - ▭ No.2 Taxiing guidance sign
  - Intermediate holding position marking

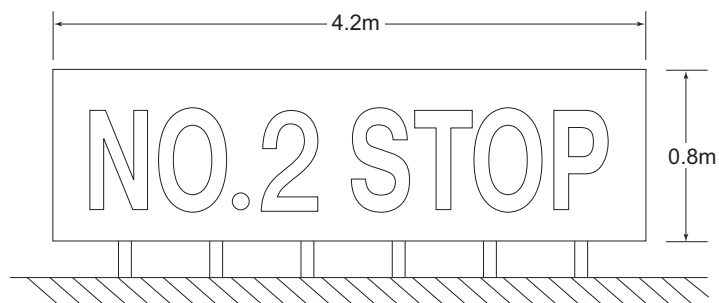

### Guide line and Guidance sign of TWY C1 & W10

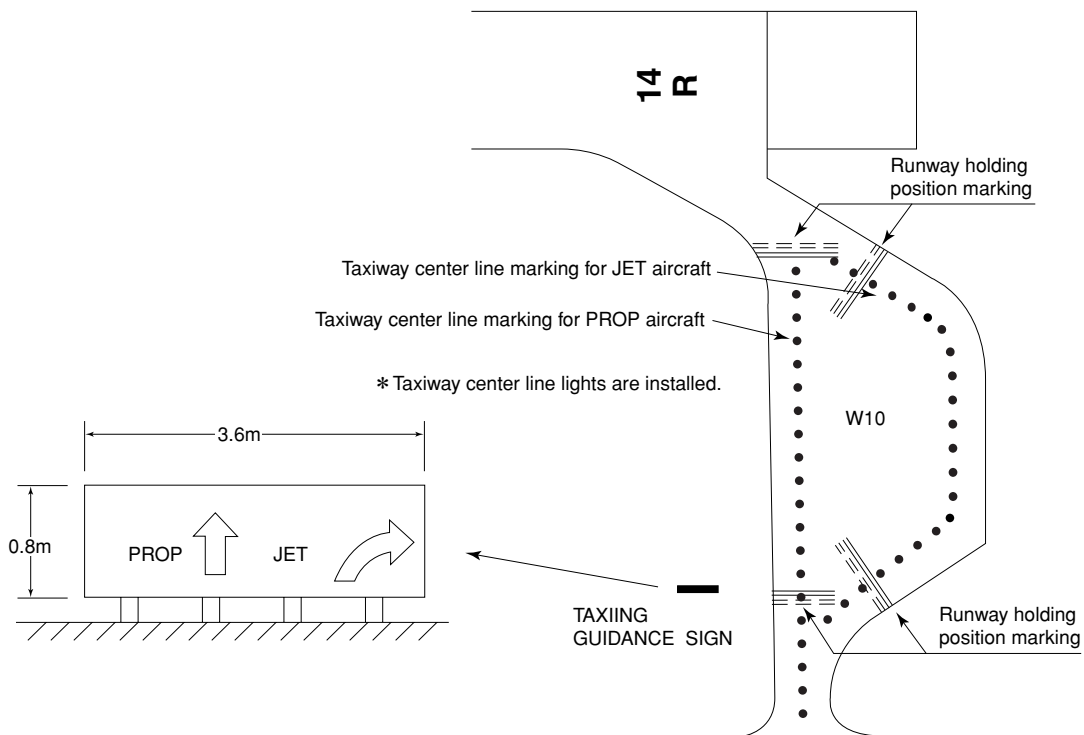
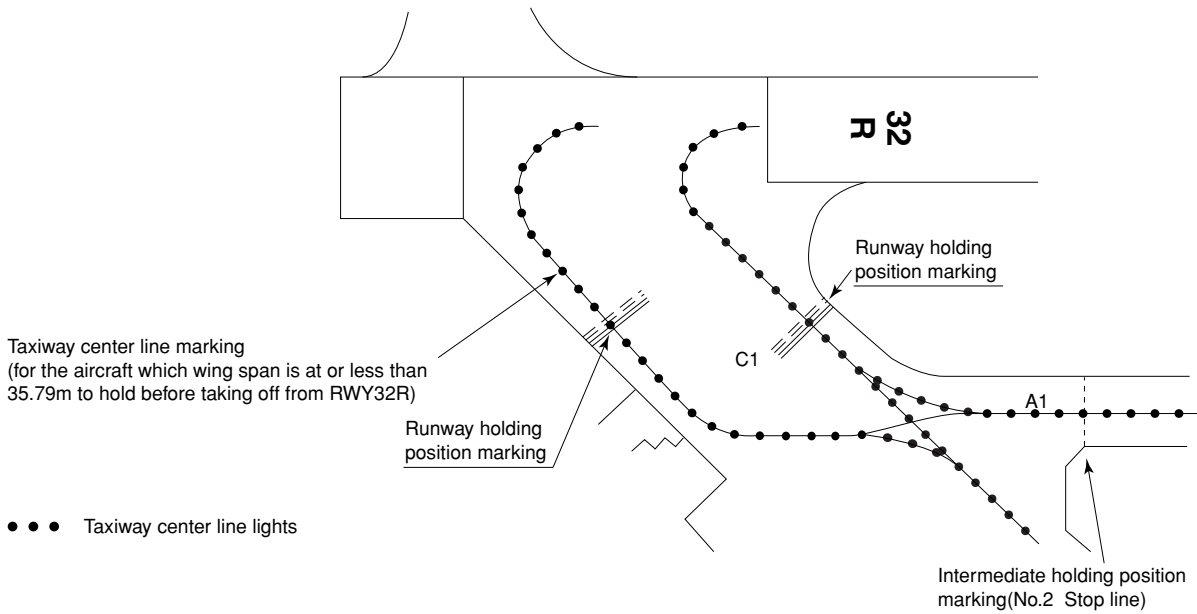

6.4 Restricted taxiways

1) A350-900 における注意して走行すべき誘導路

1) TWY required to pay special attention for A350-900

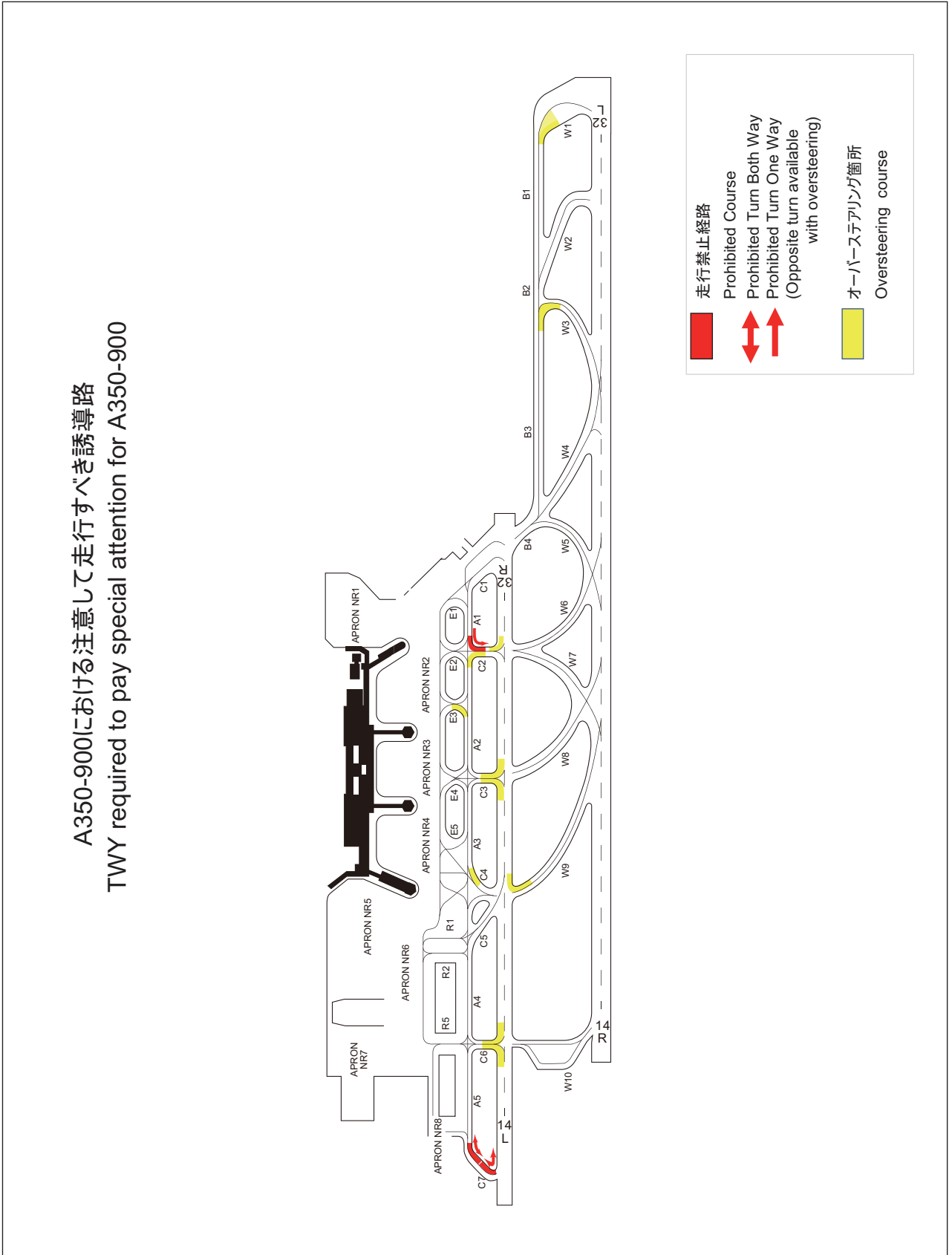

2) B767-300における注意して走行すべき誘導路

2) TWY required to pay special attention for B767-300

B767-300における注意して走行すべき誘導路  
TWY required to pay special attention for B767-300

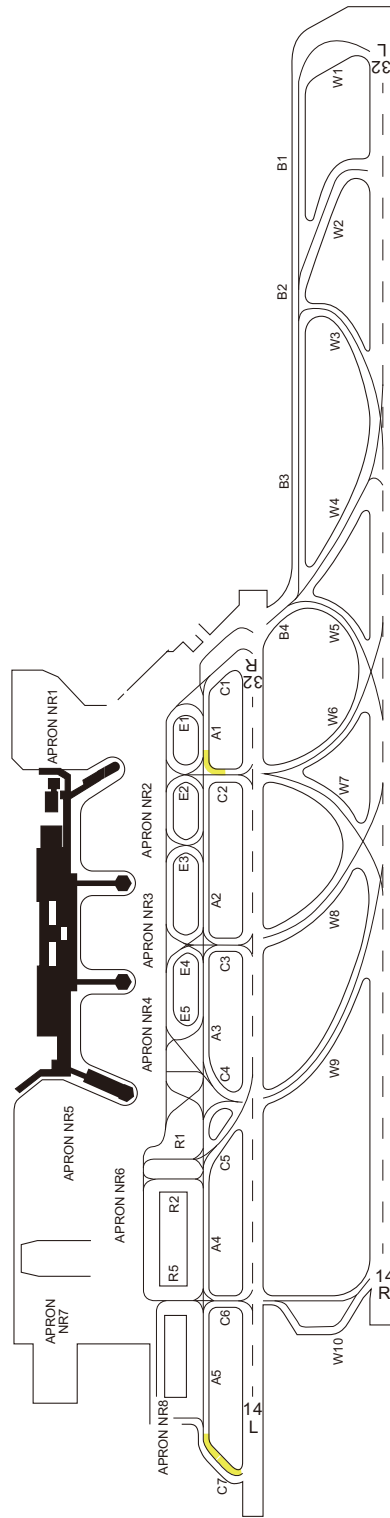

	走行禁止経路 Prohibited Course
	Prohibited Turn Both Way
	Prohibited Turn One Way (Opposite turn available with oversteering)
	オーバーステアリング箇所 Oversteering course

3) B777-200 における注意して走行すべき誘導路

3) TWY required to pay special attention for B777-200

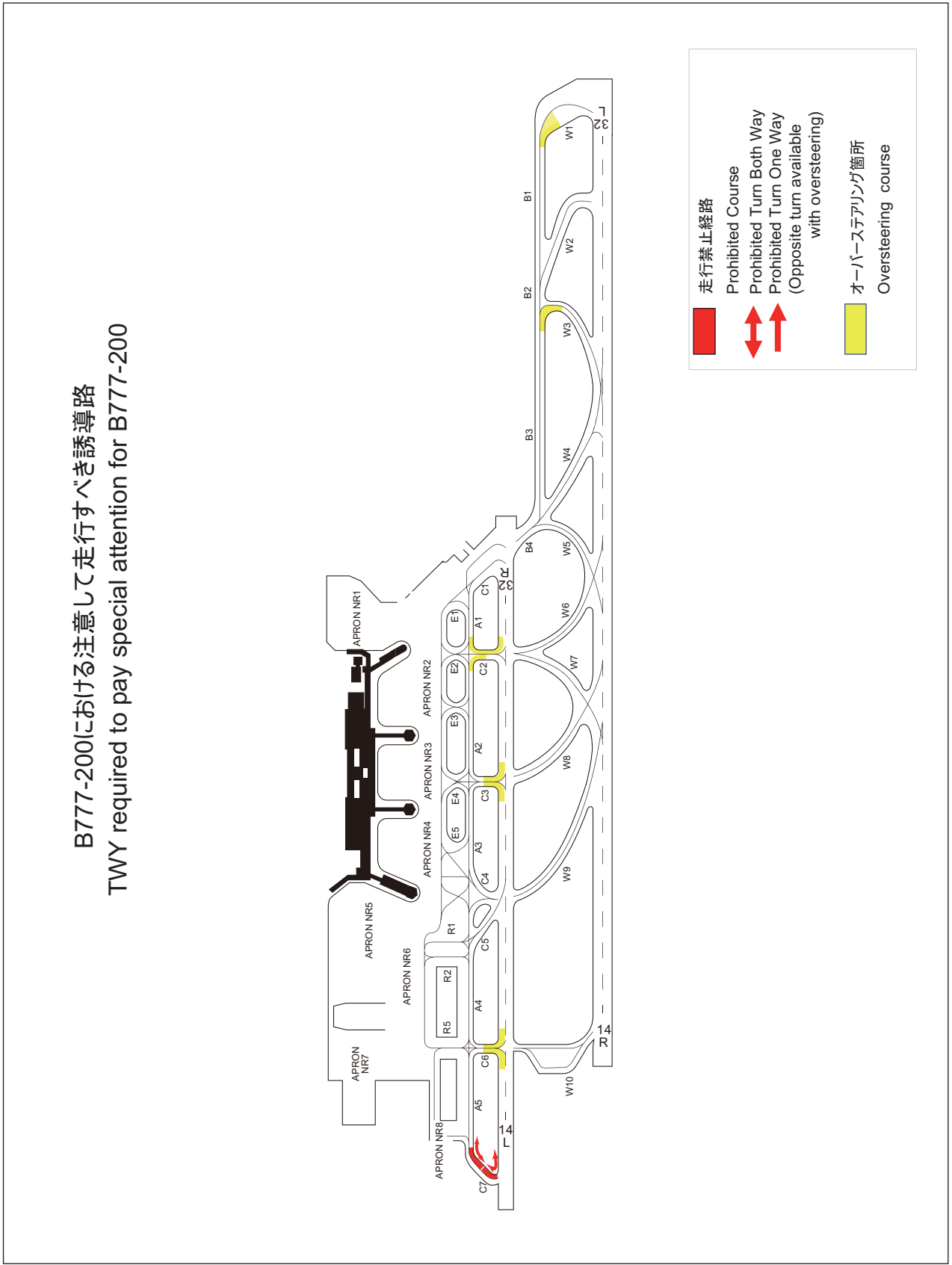



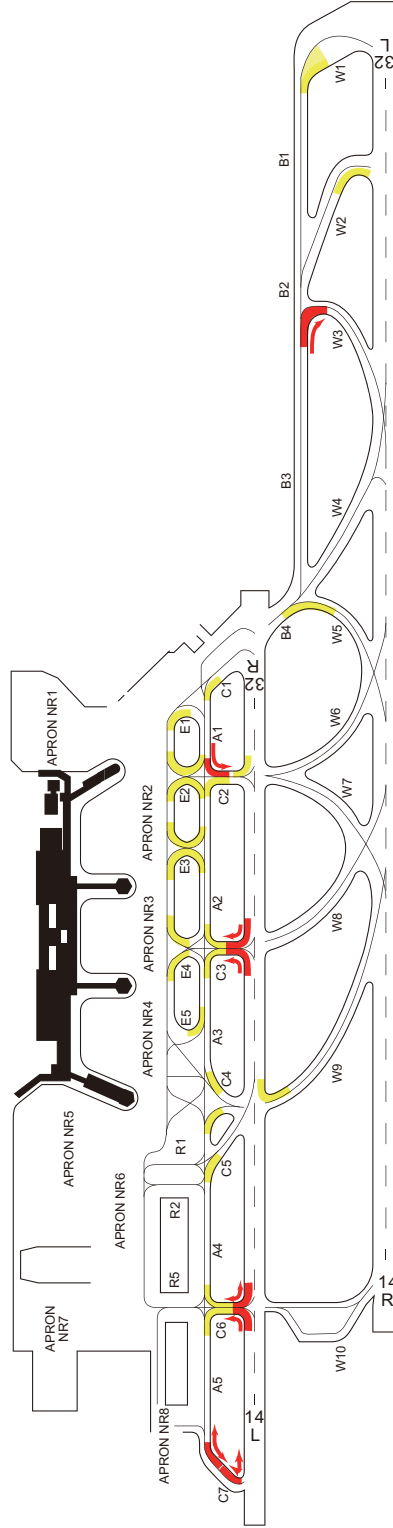

4) B777-300における注意して走行すべき誘導路

4) TWY required to pay special attention for B777-300

B777-300における注意して走行すべき誘導路  
TWY required to pay special attention for B777-300



	走行禁止経路
	Prohibited Course
	Prohibited Turn Both Way
	Prohibited Turn One Way (Opposite turn available with oversteering)
	オーバーステアリング箇所 Oversteering course



5) B787-8における注意して走行すべき誘導路

5) TWY required to pay special attention for B787-8

B787-8における注意して走行すべき誘導路  
TWY required to pay special attention for B787-8

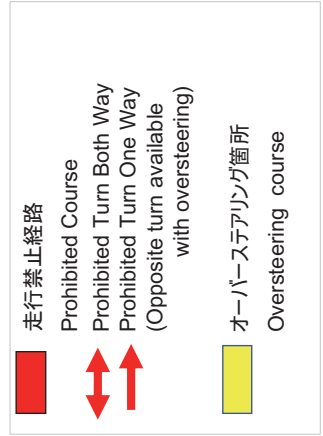
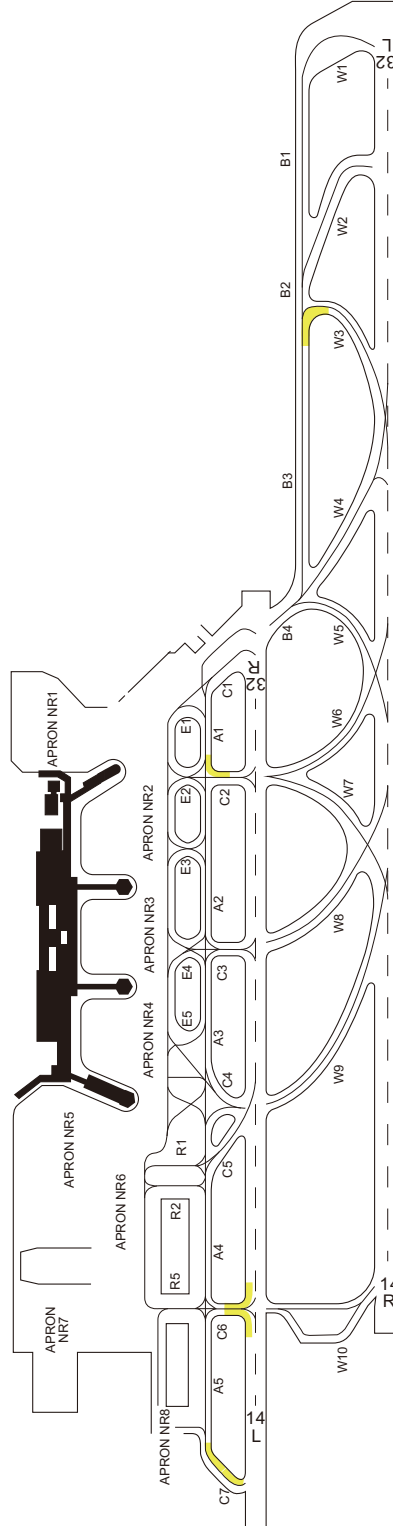

6) B787-9における注意して走行すべき誘導路

6) TWY required to pay special attention for B787-9

B787-9における注意して走行すべき誘導路  
TWY required to pay special attention for B787-9

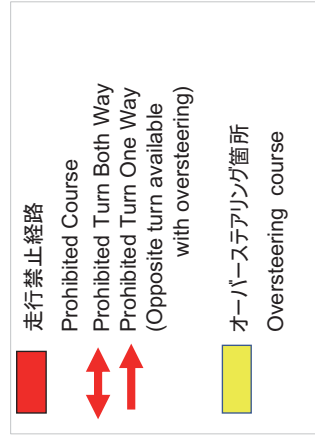
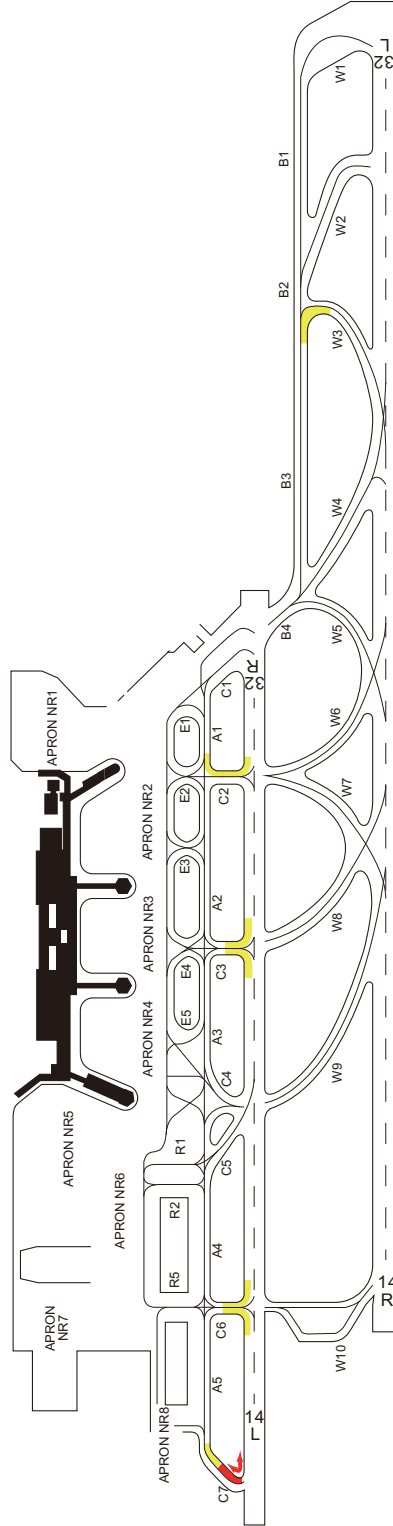

7) 航空機重量制限

7) Aircraft weight restriction

下図の区域を使用する A350-900 型機においては、航空機重量が下表の値を超えてはならない。

When A350-900 uses area in the figure below, aircraft weight shall not exceed the values listed in the table below.

航空機重量 Aircraft weight	
(lb)	(kg)
578,000	262,000

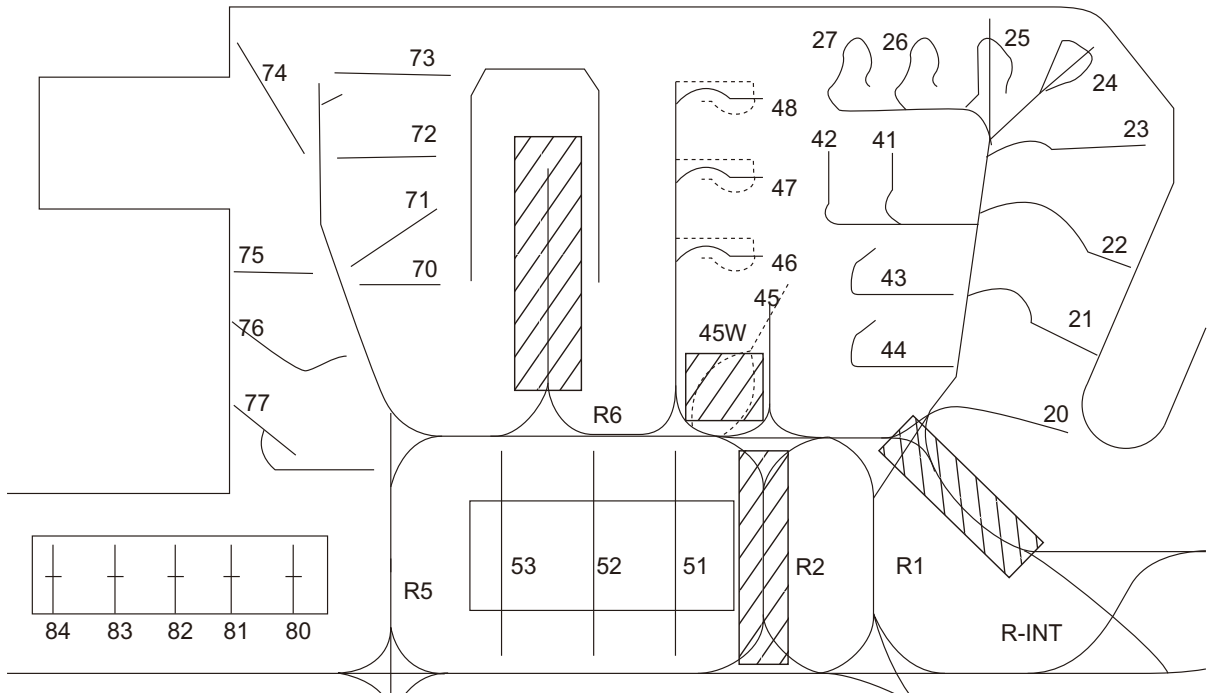

Restricted area

## 7. School and training flights - technical test flights - use of runways

Nil

## 8. Helicopter traffic - limitation

Nil

## 9. Removal of disabled aircraft from runways

Nil

**RJOO AD 2.21 NOISE ABATEMENT PROCEDURES**

## 1. Local flying restrictions:

1.1 In order to reduce the noise impact in the vicinity of airport, no jet airplane fitted with three or more engines shall be permitted to operate except in an emergency situation or with prior permission of the airport administrator.

1.2 No aircraft which produce the noise exceeding the maximum allowable levels shown in the following table, shall, except in an emergency situation, be permitted to operate. However, A-300 type of aircraft shall not exceed the noise level 97dB (A) whenever take off from RWY 32L/R.

Time(UTC)	Maximun Allowable Noise Level
22:00 - 11:00	107 dB (A)
11:01 - 12:00	100 dB (A) for take off, 107 dB (A) for landing

Note: (a) All aircraft operators are requested to present in advance their "Operation Manuals" to the airport authority, giving there in the detailed information on the following items specified for each time bracket and aircraft type.

- (1) Maximum takeoff weight calculated for each runway to be used, temperature, and headwind component.
- (2) Flap angle.
- (3) Climb speed.

(b) The figures of the noise level shown in the above Table will be the value to be measured by the noise monitoring equipment installed at the position 2,400 meter from the threshold of Runway 14R on 315 DEG magnetic (Kushiro Primary School).

1.3 Aircraft using taxiway B and departing from runway 32L at Osaka International Airport, in principle, shall make Intersection takeoff via taxiway W2. In this case, available runway length is 2700m from runway 14R threshold. In case of having intention of making full length takeoff for the operational requirements, the pilot shall advise ATC to that effect when he initiates call for ATC clearance and shall follow procedures under specified.

- (a) In principle, departing aircraft shall not hold on taxiway W1.
- (b) In principle, aircraft shall hold short of NO.1 stop line until receiving taxi clearance.
- (c) Whenever practicable, pilots are urged to make rolling takeoff without stopping at the threshold and to achieve takeoff power at position 370m from the threshold with gradual advance of power lever after passing the threshold.

1.4 For landing on Runway 32 and 14: A non-instrument or visual approach shall not be made at an angle less than the ILS glide path or PAPI indicates.

1.5 For circling approach to Runway 14: Weather conditions permitting, an aircraft making circling approach is to be requested to maintain an altitude as high as practicable.

2. 騒音軽減運航方式

- (1) すべてのジェット機に対して、空港周辺における航空機騒音軽減のため、運航の安全に支障のない範囲で、以下の方式が適用される。ただし、これらの方式によることができない航空機は実効的にこれらと同等と認められる代替方式を実施するものとする。
- i) 離陸について  
急上昇方式
  - ii) 着陸について  
ディレイド・フラップ進入方式及び  
低フラップ角着陸方式
  - iii) リバース・スラストについて (RWY32L 着陸時)  
19時から21時までの間、リバース・スラスト使用はアイドルまでに制限する。
- (2) 優先滑走路方式  
なし
- (3) 優先飛行経路  
すべての離陸機を対象に、空港周辺地域における航空機騒音の影響を受ける区域の拡大を防止するため、次のような優先飛行経路が運航の安全に支障がない範囲で適用される。
- i) 滑走路 32R/32L から離陸する場合  
離陸後 ITE VOR/DME 附近上空を通過し、かつ北端を中国縦貫道路、南端を瑞ヶ池及び昆陽池並びに西端を武庫川で囲まれる範囲を飛行するよう左上昇旋回を継続し、ITE VOR/DME 2.2DME を通過した後、標準計器出発方式に従うこと。
  - ii) 滑走路 14R/14L から離陸する場合  
離陸後、阪神高速道路まで直線飛行し、その後旋回上昇に移し、標準計器出発方式に従うこと。

注) 上記地上物標については、付図を参照のこと。

2. Noise Abatement Operating Procedures

- (1) For all jet aircraft, in order to reduce aircraft noise in the vicinity of airport, the following procedures shall be applied unless compliance of the procedures adversely affects the safety of aircraft operations. In case that the aircraft is unable to take these procedures, pilots should execute alternative procedures which are considered to be practically equivalent.
- i) For take-off  
Steepest Climb Procedure
  - ii) For landing  
Delayed Flap Approach Procedure and Reduced Flap Setting Procedure
  - iii) Reverse Thrust (landing RWY32L)  
Between 1000UTC (1900JST) and 1200UTC (2100JST), the use of reverse thrust is limited to idle except for safety reasons.
- (2) Preferential Runways Procedures  
Nil
- (3) Noise Preferential Routes  
For all departing aircraft, in order to prevent the enlargement of aircraft noise affected area around the airport, the following noise preferential routes are applied except for safety reasons.
- i) Take-off from runway 32R/32L:  
After take-off, execute continuous left climbing turn so as to pass over near ITE VOR/DME and keep flight track within the area defined by Chugoku Express Way at the north end, ponds of Zuga and Koya at the south end, and Muko River at the west end until crossing ITE VOR/DME 2.2DME, then proceed via SID.
  - ii) Take-off from runway 14R/14L:  
After take-off, strictly follow extended runway centerline until passing Hanshin Express Way and then execute climbing turn so as to proceed via SID.

Note: Refer attached chart for the above mentioned landmarks.

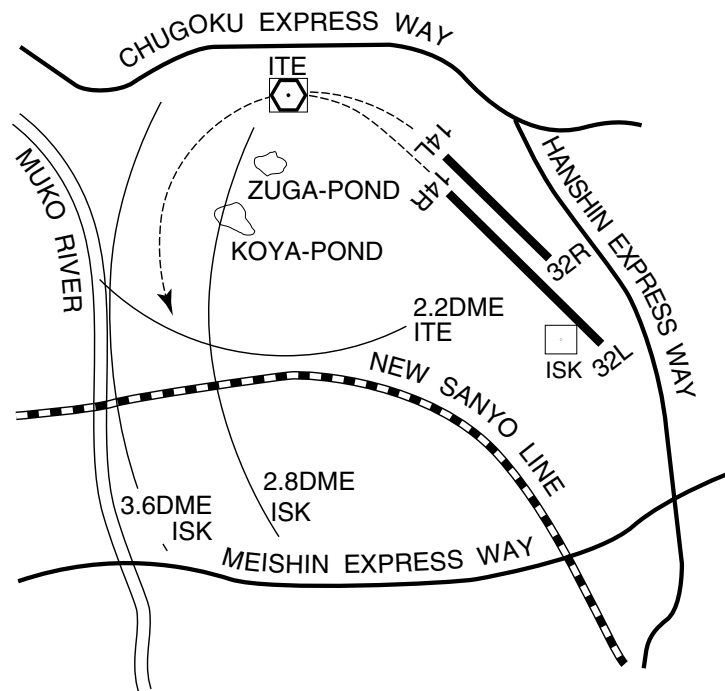

## RJOO AD 2.22 FLIGHT PROCEDURES

## 1.TAKE OFF MINIMA

	RWY	REDL & RCLL AVBL		REDL or RCLL AVBL		REDL & RCLL OUT	
		CEIL-RVR	CEIL-VIS	CEIL-RVR	CEIL-VIS	CEIL-RVR	CEIL-VIS
TKOF ALTN AP FILED	32R	300'-800m	300'-800m	300'-800m	300'-800m	-	300'-800m
	14L	-	200'-1600m	-	200'-1600m	-	200'-1600m
	32L	300'-800m	300'-800m	300'-800m	300'-800m	-	300'-800m
	14R	-	200'-800m	-	200'-800m	-	200'-800m
OTHER	32R	AVBL LDG MINIMA					
	14L						
	32L						
	14R						

NOTE: SIDs are designed in accordance with provisional standards for FLIGHT PROCEDURE DESIGN.

2. Lost communication procedures for arrival aircraft under radar navigational guidance  
If radio communications with Kansai Approach/Radar are lost for 1 minute, squawk Mode A/3 Code 7600 and,

(I) 1. Contact Osaka Tower.  
2. If unable, proceed in accordance with Visual Flight Rules.  
3. If unable, proceed to IZUMI at last assigned altitude or 5,000 feet whichever is higher, and execute instrument approach via IZUMI ARRIVAL.

(II) Procedures other than above will be issued when situation required.

3. Notwithstanding the requirement as mentioned "JET circling to West only" in each approach minimum column of the instrument approach charts of RJOO AIP, Boeing 727 series 100 or lighter jet ACFT may be instructed by ATC to enter into East side traffic circuit during VMC in the daytime.

4. Operation of Special VFR arrival by fixed wing aircraft NOT authorized except in an emergency situation.

5. For the purpose of preventing disasters to Petroleum Oil Liquid (POL:See AD2.24 AD chart) facilities, all aircraft making take off, landing or missed approach are requested to avoid flying over and in the vicinity of POL facilities.

**RJOO AD 2.23 ADDITIONAL INFORMATION**

1. Maintenance works will be in progress all the year round during SR to SS along the edges of RWY 14R/32L and/or 14L/32R and TWY subject to VMC.

2. Runway 14L/32R or 14R/32L is subject to closing for maintenance purpose during the hours from 1300 UTC to 2100 UTC every month. Consult NOTAM RJOO for further detailed information.

3. Position not visible from control tower.

- 1) Spot Nr.4A, 23, 24, 25, 41, 42
- 2) Apron Nr.7

4. Avoidance Flight of Mountainous Areas is shown in attached chart.

**Avoidance Flight of Mountainous Areas at OSAKA INTL Airport**

For the purpose of avoiding collision at the mountainous area shown on the chart, the aircraft taking off from RWY 32 at OSAKA International Airport should turn to the left as soon as possible with due regard to the noise at the time of climbing, but without sacrificing the flight safety.

Note: The areas of hatching are obstructions which are projecting above the plane surface having a 40:1 slope from RWY 14 threshold.

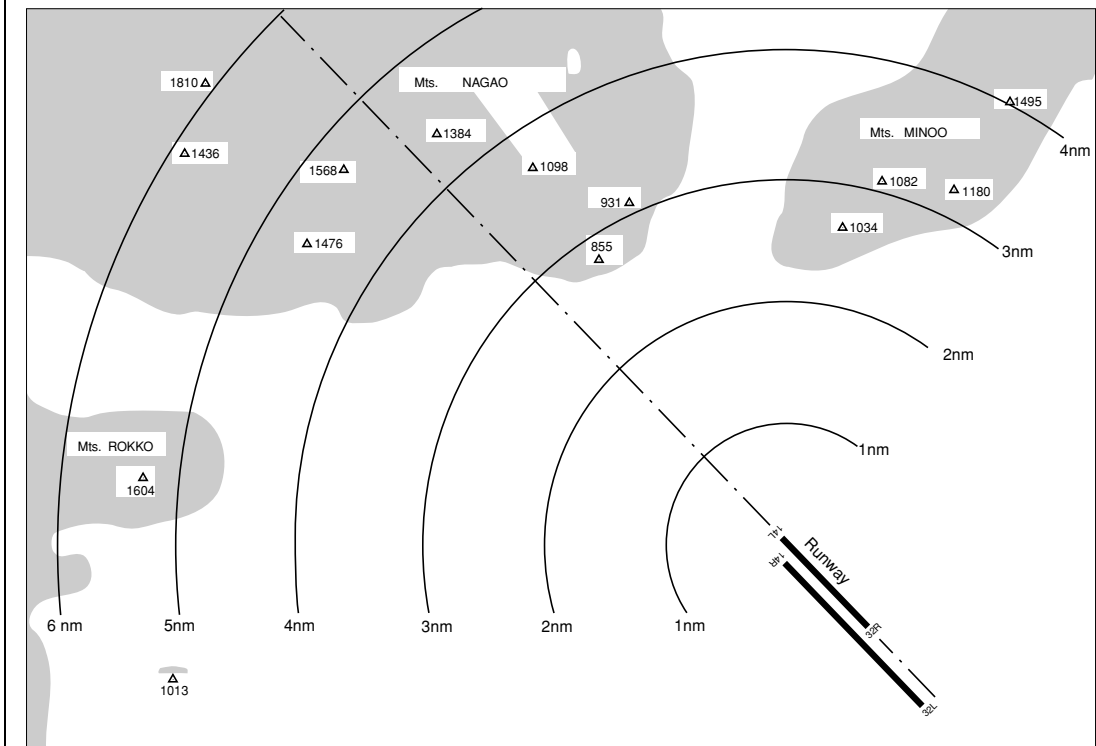

5. Helicopter Landing area

Location : On apron Nr8

Surface-Concrete TKOF/LDG areas circled

## RJOO AD 2.24 CHARTS RELATED TO AN AERODROME

Aerodrome/Heliport Chart-1  
Aerodrome/Heliport Chart-2  
Aerodrome Obstacle Chart - ICAO type A (RWY14R)  
Aerodrome Obstacle Chart - ICAO type A (RWY32L)  
Aerodrome Obstacle Chart - ICAO type A (RWY14L)  
Aerodrome Obstacle Chart - ICAO type A (RWY32R)  
Aerodrome Obstacle Chart - ICAO type B  
Standard Departure Chart - Instrument (ASUKA, PANAS)\*  
Standard Departure Chart - Instrument (RNAV TRANSITION1)  
Standard Departure Chart - Instrument (IZUMI)\*  
Standard Departure Chart - Instrument (EAST REVERSAL)\*  
Standard Departure Chart - Instrument (TIGER)\*  
Standard Departure Chart - Instrument (MINAC)\*  
Standard Departure Chart - Instrument (RNAV TRANSITION2)  
Standard Arrival Chart - Instrument (IZUMI, KODAI)  
Standard Arrival Chart - Instrument (IKOMA EAST, IKOMA NORTH, HABIK-RNAV)  
Instrument Approach Chart (ILS RWY32L)  
Instrument Approach Chart (LOC RWY32L)  
Instrument Approach Chart (VOR A)  
Instrument Approach Chart (RNAV(GNSS) RWY32L)  
Instrument Approach Chart (RNAV(GNSS) RWY32R)  
Other Chart (HOLDING PATTERN)  
Other Chart (Visual REP)  
Other Chart (LDG CHART)  
Other Chart (MVA CHART)

\*: Designed in accordance with provisional standards for FLIGHT PROCEDURE DESIGN.



AERODROME CHART

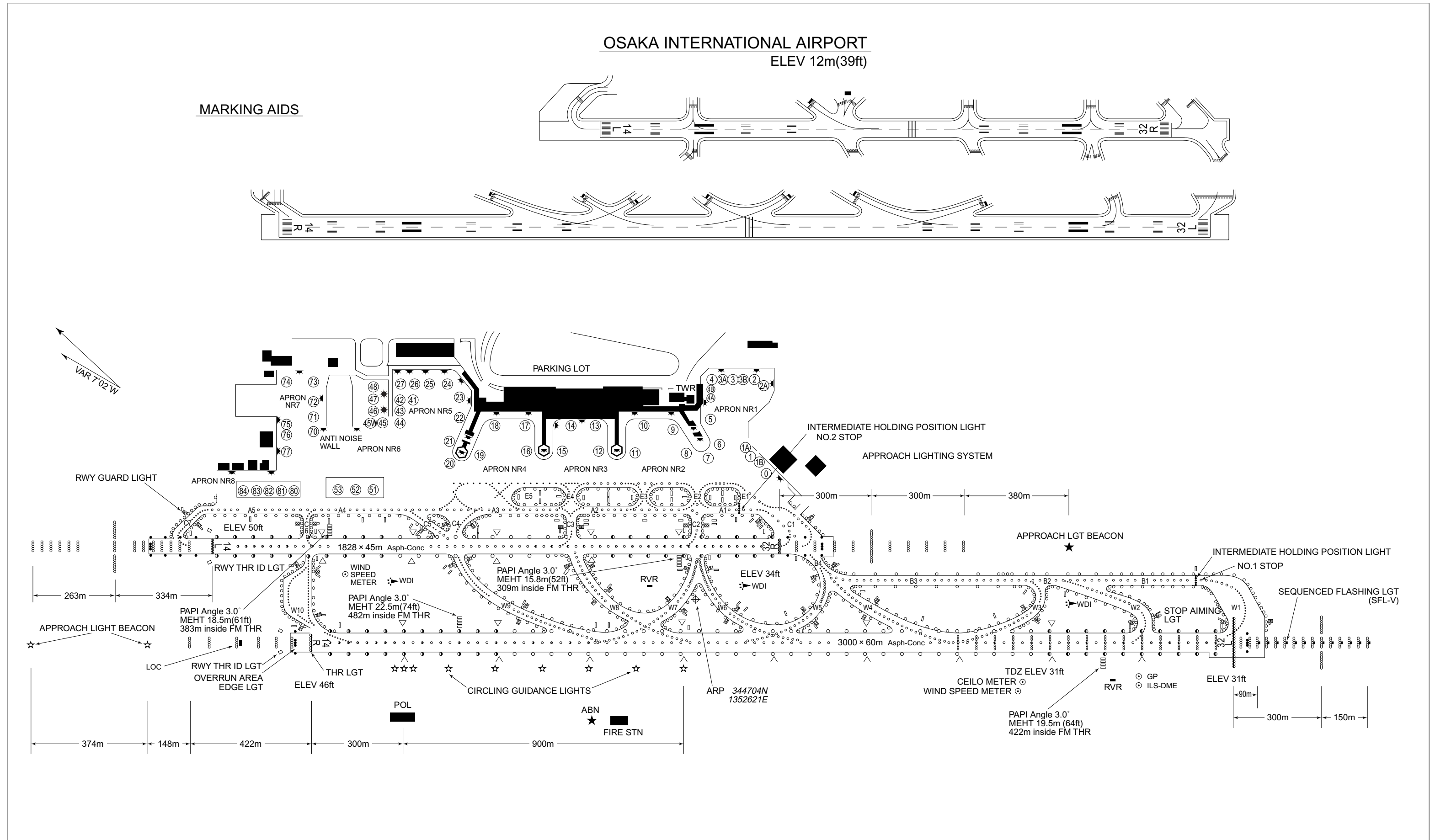

STANDARD DEPARTURE CHART -INSTRUMENT

RJOO / OSAKA INTL

SID

IZUMI ONE DEPARTURE

RWY 32R/32L : Climb RWY HDG to 500FT or above, turn left within 4NM from RWY end/ITE 2.1DME, via ITE R201 to YODOH,...

RWY 14R/14L : Climb RWY HDG to 500FT or above, turn right HDG230° to intercept and proceed via ITE R201 to YODOH,...

...turn left, via YOE R295 to intercept and proceed via ITE R184 to IZUMI.

Cross IZUMI at or above 6000FT.

Note : When take off RWY 14R/14L, following climb gradient should be maintained until 500FT.

Speed (Knots)	60	90	120	150	180	210
Rate (Feet/Min)	300	450	600	750	900	1050

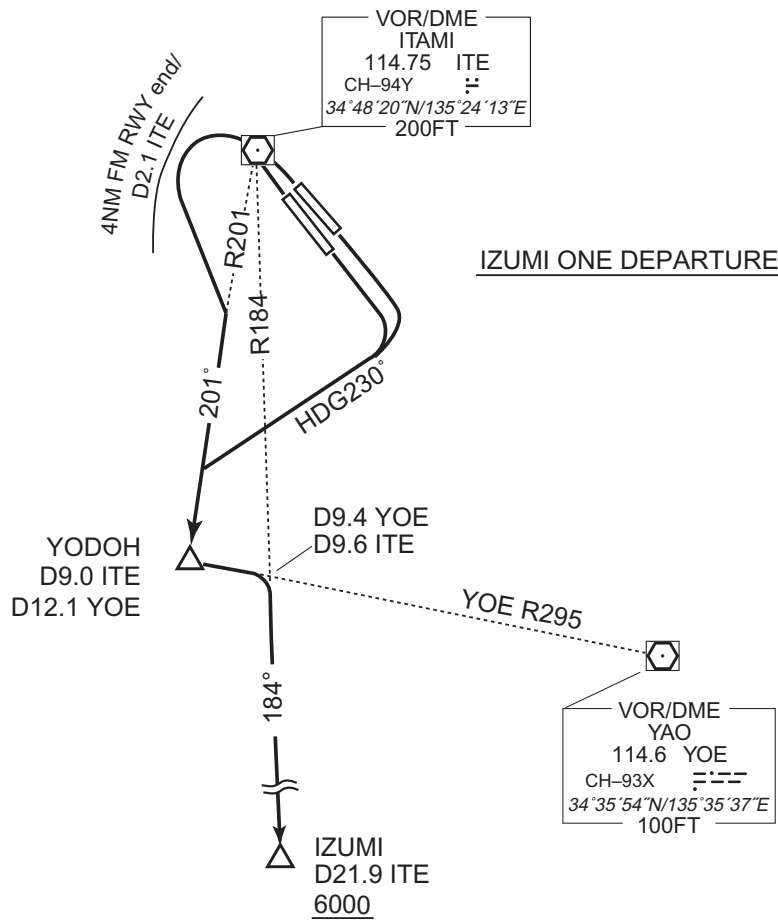

STANDARD DEPARTURE CHART -INSTRUMENT

RJOO / OSAKA INTL

SID

EAST REVERSAL FOUR DEPARTURE

RWY 32R/32L : Climb RWY HDG to 500FT or above, turn left within 4NM from RWY end/ITE 2.1DME,...

RWY 14R/14L : Climb RWY HDG to 500FT or above, turn left,...  
...via ITE R101 to 3000FT or above, turn left direct to ITE VOR/DME within ITE 14.0DME.

Cross ITE VOR/DME at assigned altitude.

Note : When take off RWY 14R/14L, following climb gradient should be maintained until 500FT.

Speed (Knots)	60	90	120	150	180	210
Rate (Feet/Min)	300	450	600	750	900	1050

EAST REVERSAL FOUR DEPARTURE

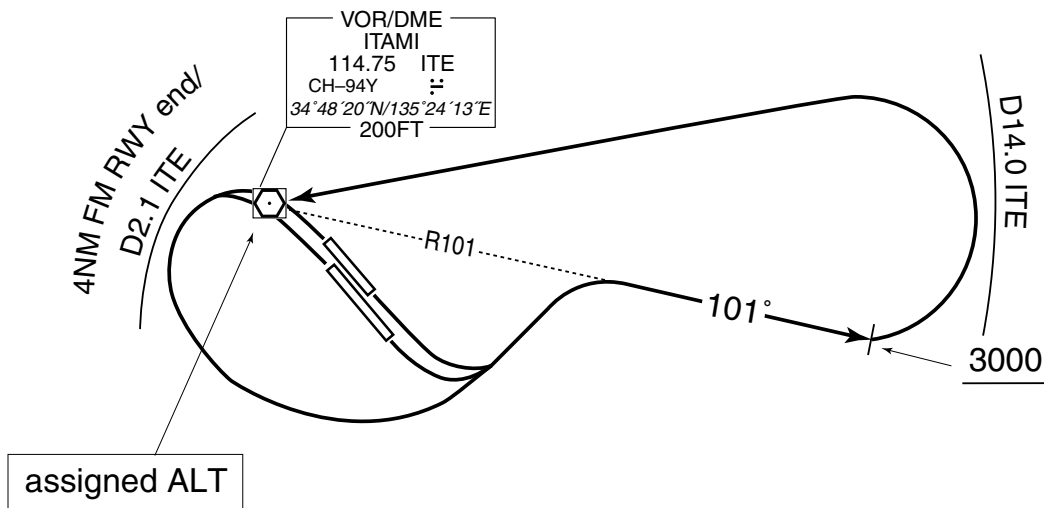

STANDARD DEPARTURE CHART -INSTRUMENT

RJOO / OSAKA INTL

SID

TIGER TWO DEPARTURE

RWY 32R/32L : Climb RWY HDG to 500FT or above, turn left within 4NM from RWY end/ITE 2.1DME, via ITE R201 until crossing YOE R301...

RWY 14R/14L : Climb RWY HDG to 500FT or above, turn right HDG230° until crossing YOE R301...

...turn right to intercept and proceed via YOE R291 to TIGER.

Cross TIGER at or above 6000FT.

Note : Following climb gradient should be maintained until 2500FT.

Speed (Knots)	60	90	120	150	180	210
Rate (Feet/Min)	300	450	600	750	900	1050

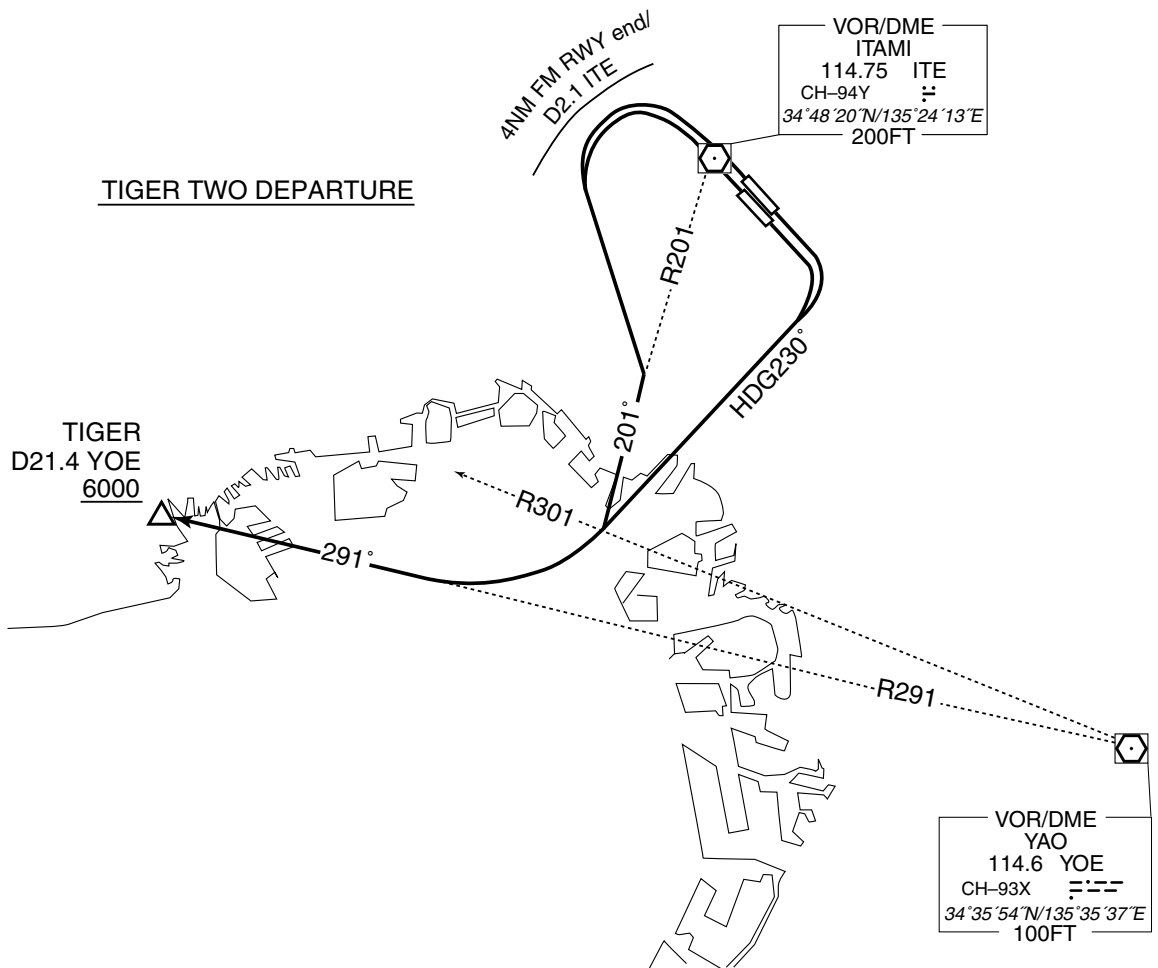

STANDARD DEPARTURE CHART -INSTRUMENT

RJOO / OSAKA INTL

TRANSITION

KAGAWA TRANSITION

From over TIGER, via YOE R291 to SUMAR, via ITE R260 to intercept and proceed via KTE R057 to KTE VOR/DME.

Cross SUMAR at or above 9000FT, cross ITE R260/43.1DME at or above FL180.

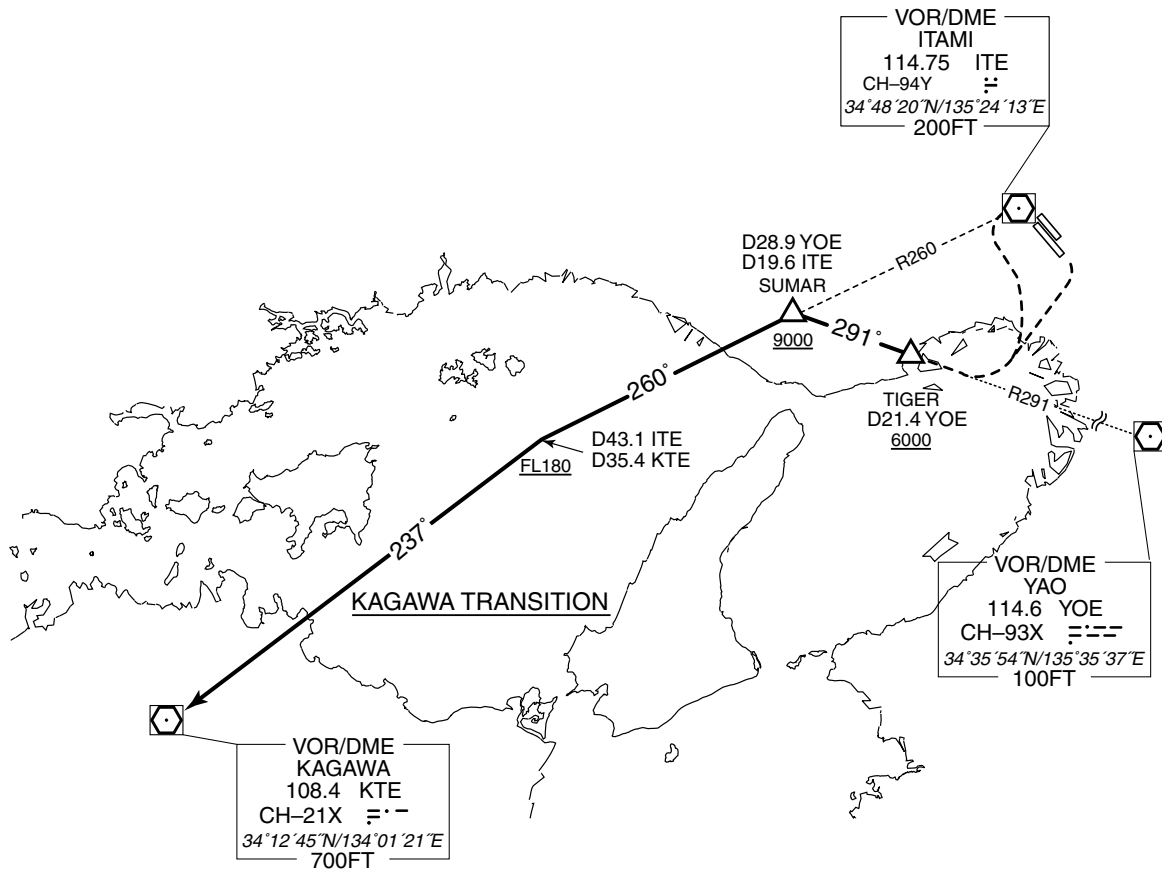

STANDARD DEPARTURE CHART -INSTRUMENT

RJOO / OSAKA INTL

TRANSITION

ASAGI TRANSITION

From over TIGER, via KCE R324 to ASAGI.  
Cross KCE R324/22.4DME at or above 7000FT.

TOZAN TRANSITION

From over TIGER, via KCE R324 to TOZAN, via ASAGI.  
Cross KCE R324/22.4DME at or above 7000FT, cross KCE R324/47.0DME at or above 10000FT.

BUMER TRANSITION

From over TIGER, via YOE R291 to intercept and proceed via KCE R311 to BUMER.

CHANGE : TOZAN TRANSITION. Radial FM KCE.

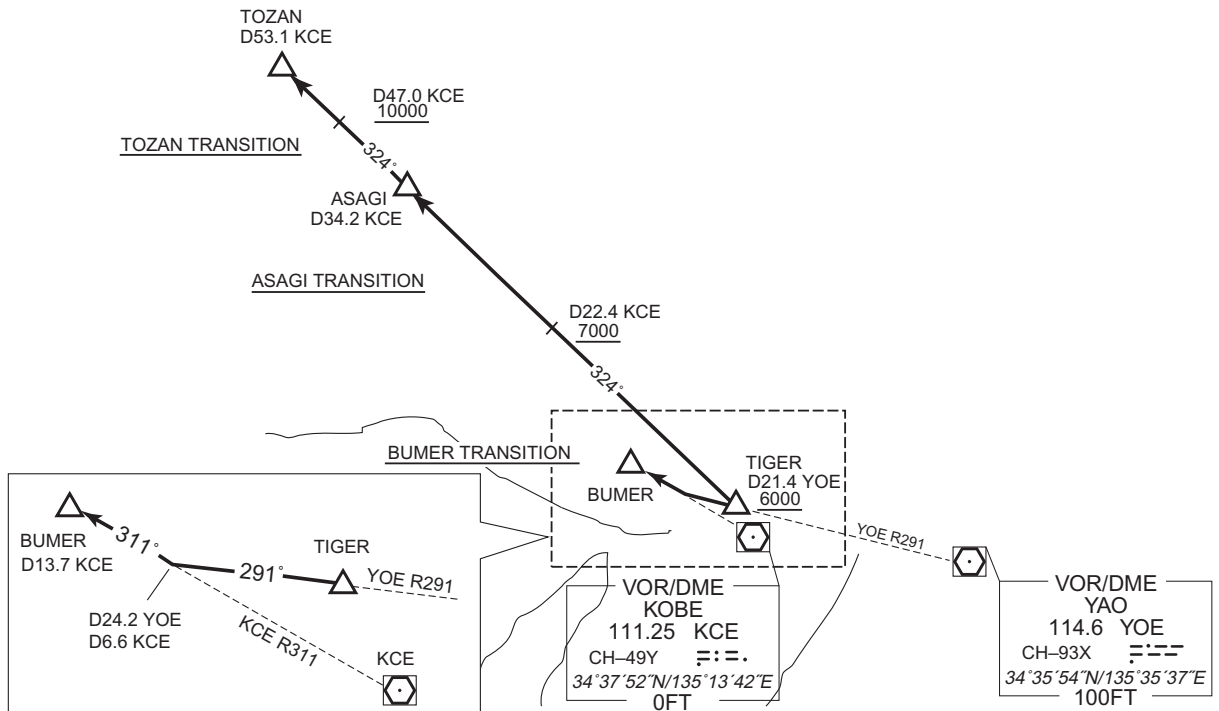

STANDARD DEPARTURE CHART-INSTRUMENT

RJOO / OSAKA INTL

SID and TRANSITION

MINAC FOUR DEPARTURE

RWY 32R/32L : Climb RWY HDG to 500FT or above, turn left within 4NM from RWY end/ITE 2.1DME,...

RWY 14R/14L : Climb RWY HDG to 500FT or above, turn left, ...via ITE R101 to intercept and proceed via KCE R077 to MINAC.

Note: When take off RWY14R/14L, following climb gradient should be maintained until 500FT.

Speed (Knots)	60	90	120	150	180	210
Rate (Feet/Min)	300	450	600	750	900	1050

NAGOYA TRANSITION

From over MINAC, via KCE R077 to YOKKA, via KCC R243 to KCC VORTAC.

CHANGE : PROC renamed. Radial FM KCE.

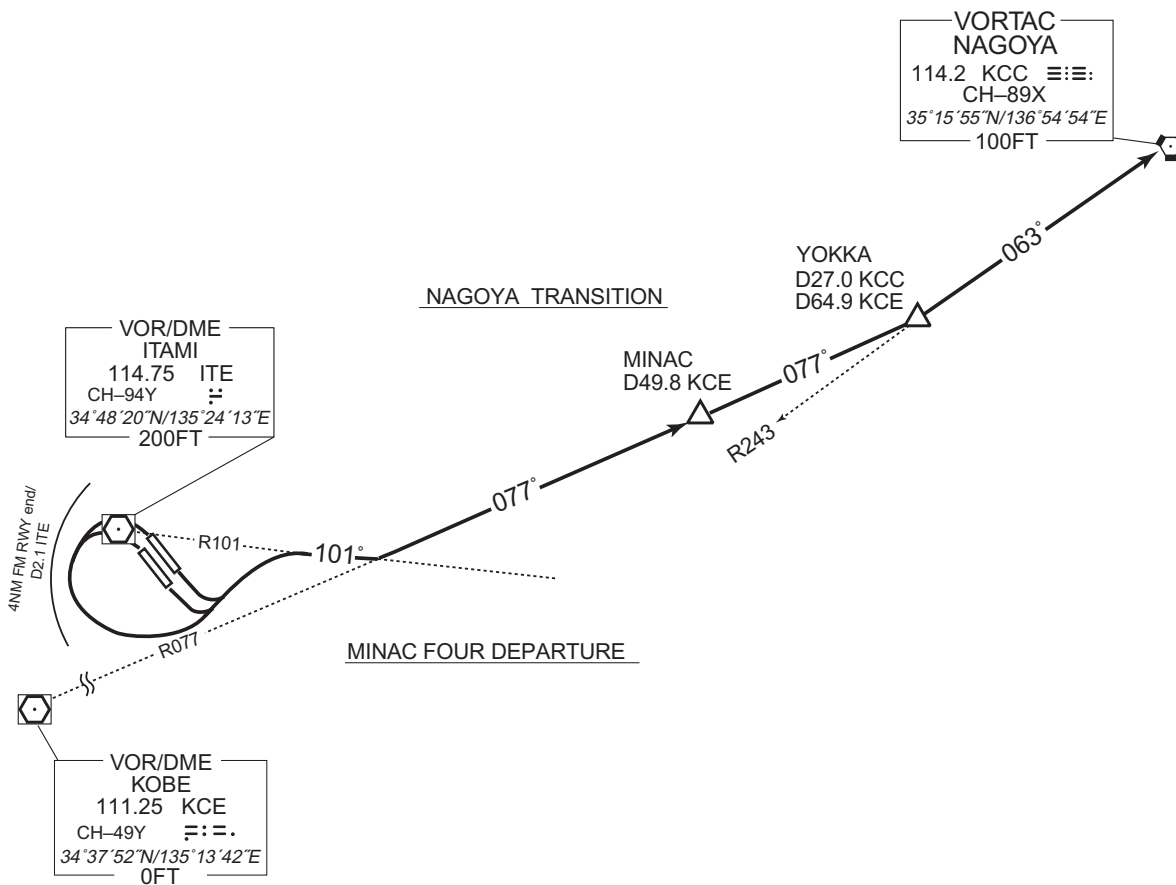

STANDARD DEPARTURE CHART-INSTRUMENT

RJOO / OSAKA INTL

RNAV TRANSITION

GUJYO TRANSITION / SHTLE TRANSITION		RNAV1
NOTE 1) DME/DME/IRU or GNSS required. 2) RADAR service required.	Critical DME	-
	DME GAP	-
	Inappropriate Nav aids	See AD1.1.6.10.3. Inappropriate NAVAIDs for RNAV1

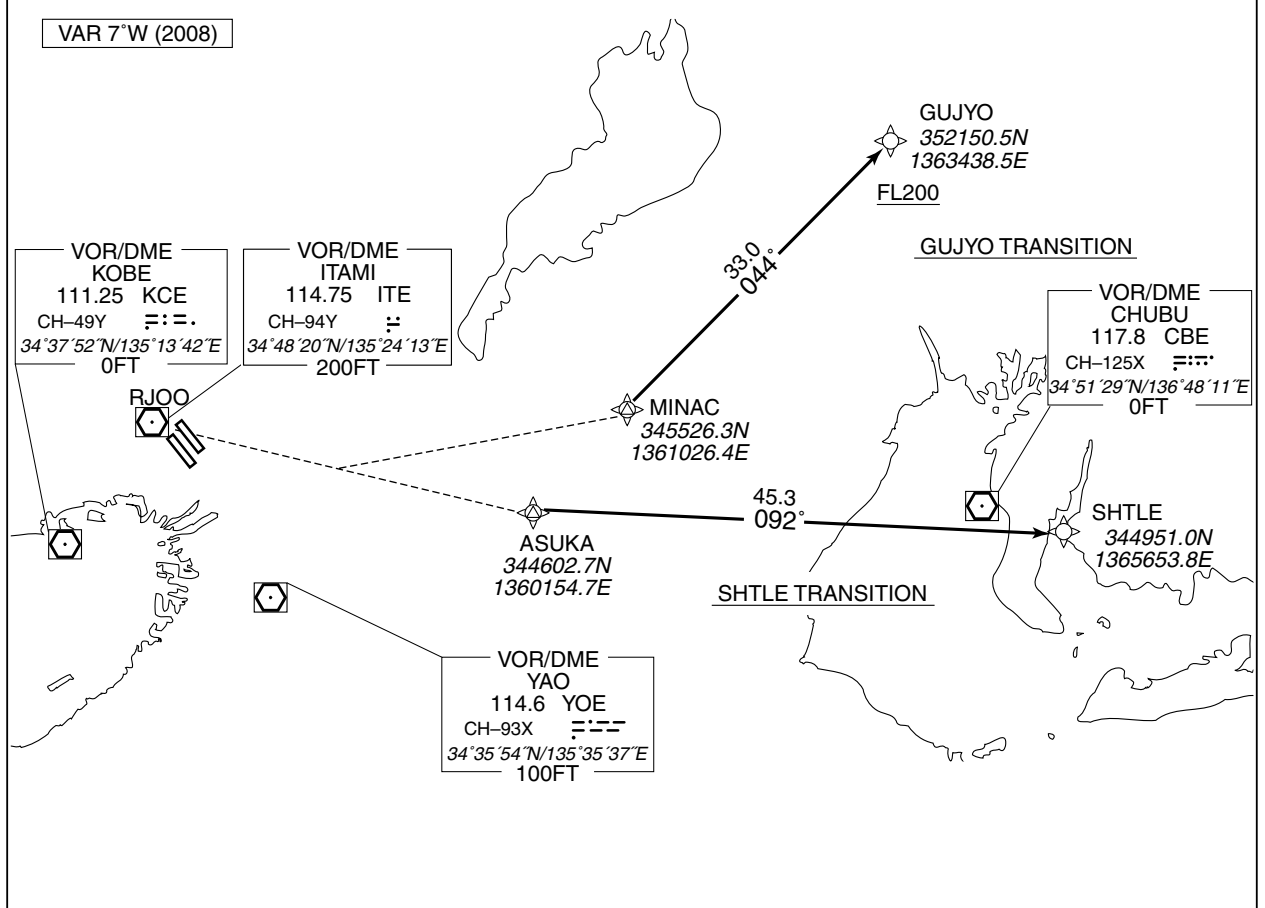

GUJYO TRANSITION

From MINAC, to GUJYO at or above FL200.

Serial Number	Path Descriptor	Waypoint Identifier	Fly Over	Course °M(°T)	Magnetic Variation	Distance (NM)	Turn Direction	Altitude (FT)	Speed (KIAS)	Vertical Angle	Navigation Specification
001	IF	MINAC	—	—	-7.1	—	—	—	—	—	RNAV1
002	TF	GUJYO	—	044 (036.7)	-7.1	33.0	—	+FL200	—	—	RNAV1

SHTLE TRANSITION

From ASUKA, to SHTLE.

Serial Number	Path Descriptor	Waypoint Identifier	Fly Over	Course °M(°T)	Magnetic Variation	Distance (NM)	Turn Direction	Altitude (FT)	Speed (KIAS)	Vertical Angle	Navigation Specification
001	IF	ASUKA	—	—	-7.1	—	—	—	—	—	RNAV1
002	TF	SHTLE	—	092 (084.9)	-7.1	45.3	—	—	—	—	RNAV1



STANDARD DEPARTURE CHART-INSTRUMENT

RJOO / OSAKA INTL

RNAV TRANSITION

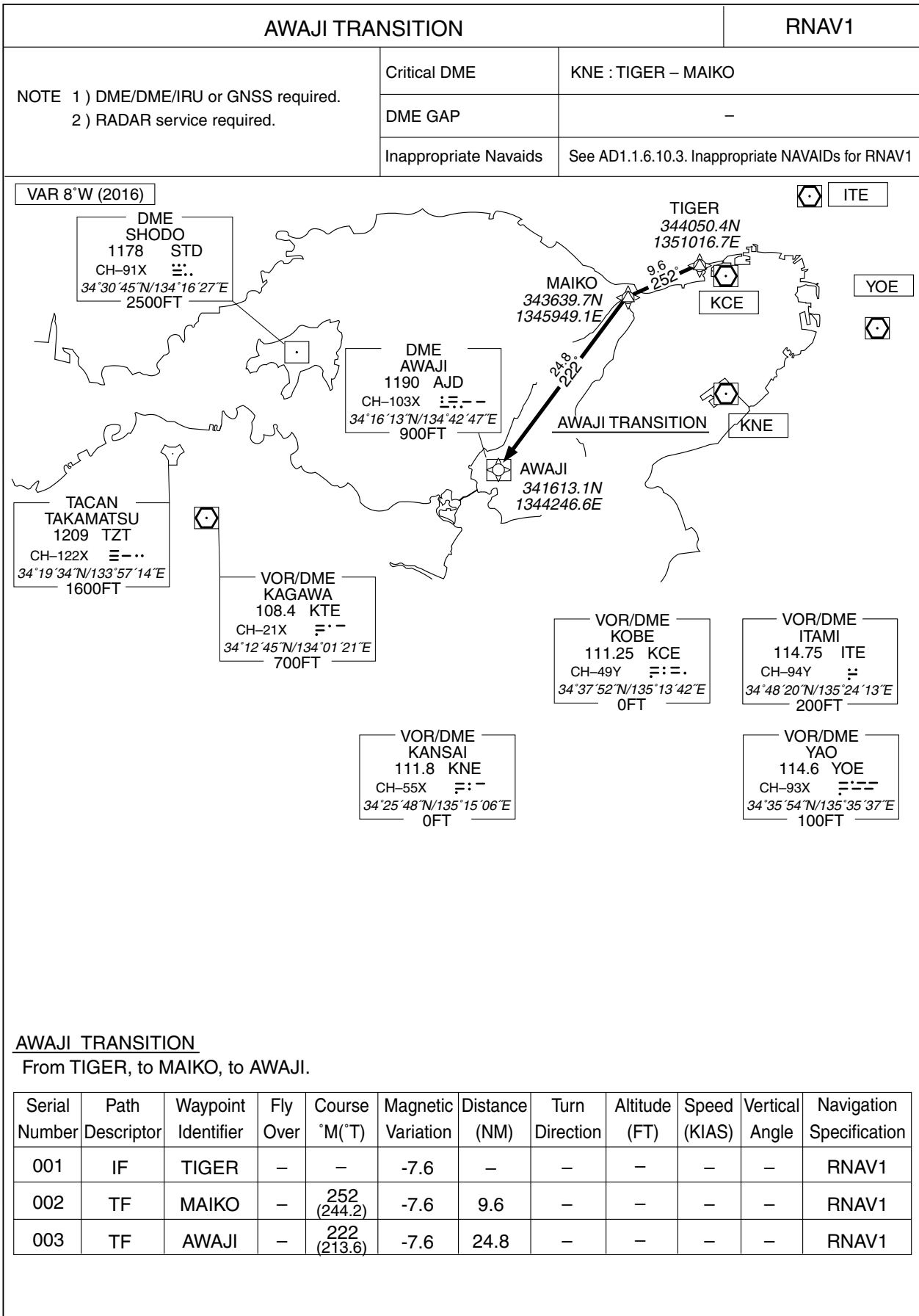

STANDARD DEPARTURE CHART-INSTRUMENT

RJOO / OSAKA INTL

RNAV TRANSITION

AYAME TRANSITION / SOUJA TRANSITION / WASYU TRANSITION		RNAV1
NOTE 1) DME/DME/IRU or GNSS required. 2) RADAR service required.	Critical DME	-
	DME GAP	-
	Inappropriate Nav aids	See AD1.1.6.10.3. Inappropriate NAVAIDs for RNAV1

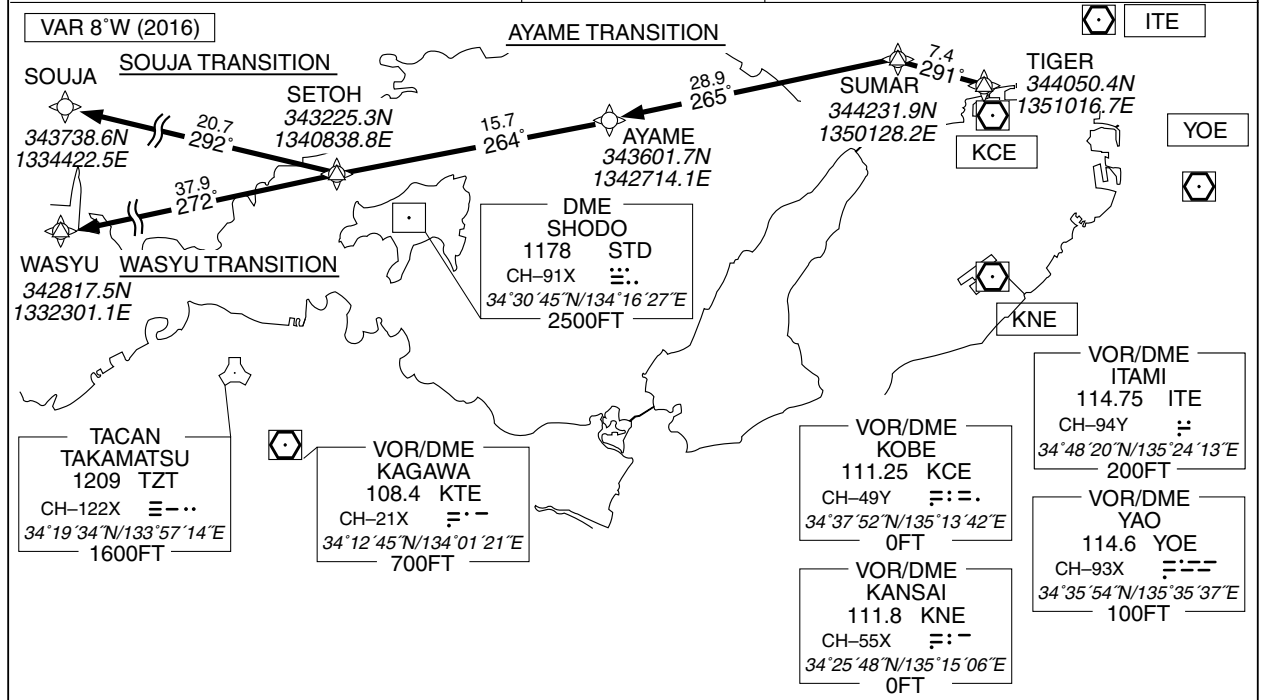

**AYAME TRANSITION**

From TIGER, to SUMAR, to AYAME.

Serial Number	Path Descriptor	Waypoint Identifier	Fly Over	Course °M(°T)	Magnetic Variation	Distance (NM)	Turn Direction	Altitude (FT)	Speed (KIAS)	Vertical Angle	Navigation Specification
001	IF	TIGER	-	-	-7.6	-	-	-	-	-	RNAV1
002	TF	SUMAR	-	291 (283.2)	-7.6	7.4	-	-	-	-	RNAV1
003	TF	AYAME	-	265 (257.2)	-7.6	28.9	-	-	-	-	RNAV1

**SOUJA TRANSITION**

From TIGER, to SUMAR, to AYAME, to SETOH, to SOUJA.

Serial Number	Path Descriptor	Waypoint Identifier	Fly Over	Course °M(°T)	Magnetic Variation	Distance (NM)	Turn Direction	Altitude (FT)	Speed (KIAS)	Vertical Angle	Navigation Specification
001	IF	TIGER	-	-	-7.6	-	-	-	-	-	RNAV1
002	TF	SUMAR	-	291 (283.2)	-7.6	7.4	-	-	-	-	RNAV1
003	TF	AYAME	-	265 (257.2)	-7.6	28.9	-	-	-	-	RNAV1
004	TF	SETOH	-	264 (256.8)	-7.6	15.7	-	-	-	-	RNAV1
005	TF	SOUJA	-	292 (284.8)	-7.6	20.7	-	-	-	-	RNAV1

## STANDARD DEPARTURE CHART-INSTRUMENT

RJOO / OSAKA INTL

RNAV TRANSITION

## WASYU TRANSITION

From TIGER, to SUMAR, to AYAME, to SETOH, to WASYU.

Serial Number	Path Descriptor	Waypoint Identifier	Fly Over	Course °M(°T)	Magnetic Variation	Distance (NM)	Turn Direction	Altitude (FT)	Speed (KIAS)	Vertical Angle	Navigation Specification
001	IF	TIGER	—	—	-7.6	—	—	—	—	—	RNAV1
002	TF	SUMAR	—	291 (283.2)	-7.6	7.4	—	—	—	—	RNAV1
003	TF	AYAME	—	265 (257.2)	-7.6	28.9	—	—	—	—	RNAV1
004	TF	SETOH	—	264 (256.8)	-7.6	15.7	—	—	—	—	RNAV1
005	TF	WASYU	—	272 (263.9)	-7.6	37.9	—	—	—	—	RNAV1

STANDARD ARRIVAL CHART-INSTRUMENT

RJOO / OSAKA INTL

STAR

IZUMI ARRIVAL

From over IZUMI, via ITE 21.9DME counterclockwise ARC to intercept and proceed via ITE R141 to IKOMA.

Cross ITE R141/19.0DME at or above 4000FT, cross IKOMA at or above 3500FT.

KODAI ARRIVAL

From over KODAI, via YOE R113 to intercept and proceed via ITE R141 to IKOMA.

Cross KODAI at or above 9000FT, cross YOE R113/21.0DME at or above 4700FT, cross ITE R141/19.0DME at or above 4000FT, cross IKOMA at or above 3500FT.

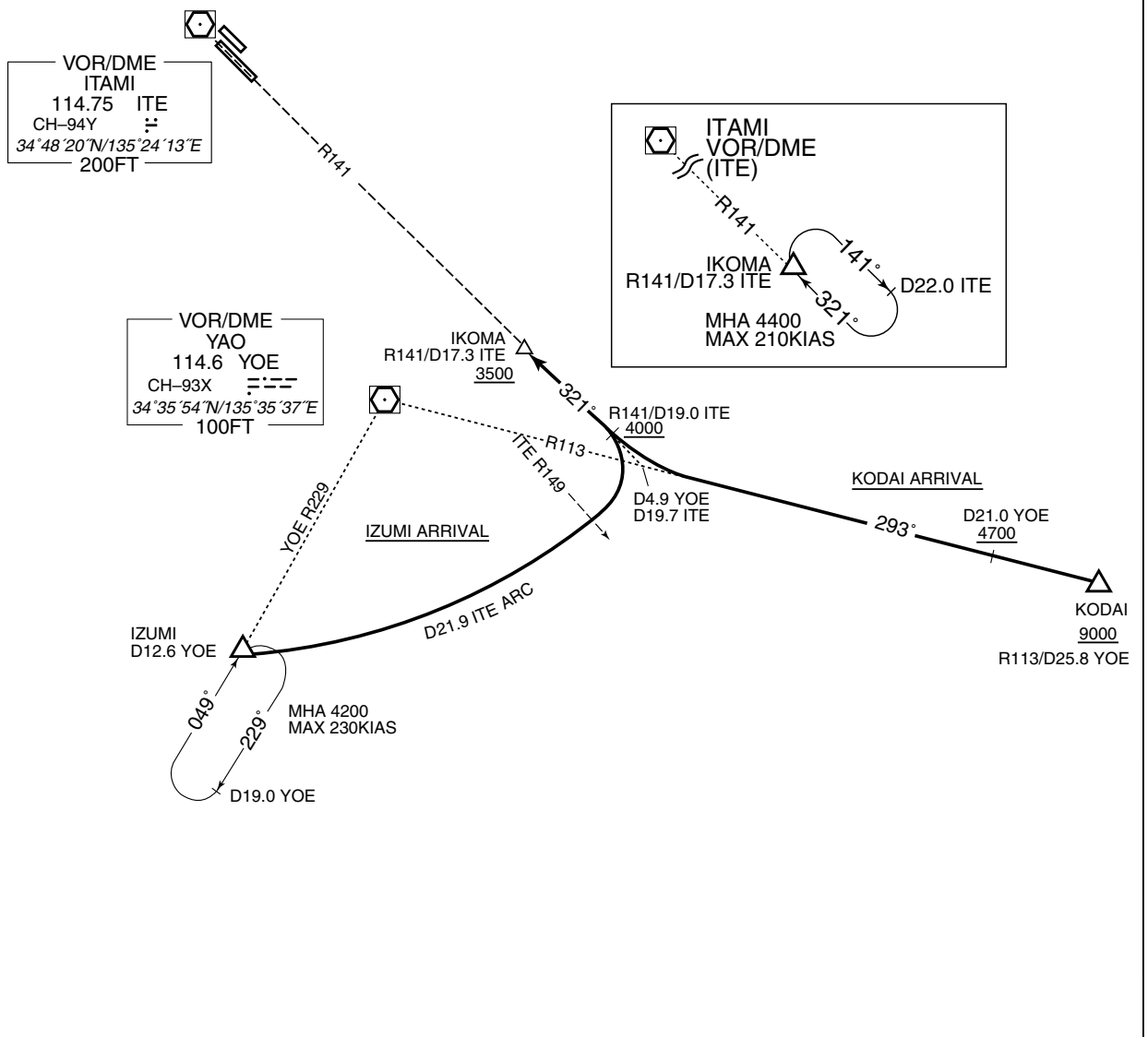

INSTRUMENT APPROACH CHART

RJOO / OSAKA INTL

RNAV(GNSS) RWY32L

KANSAI APP 120.45 - 124.7 261.2	1. DME/DME not authorized. 2. RADAR service required. 3. GNSS required.	OSAKA TOWER 118.1 - 236.8 126.2 - 121.7G	RADAR AVBL ATIS 128.6
---------------------------------------	---	--	--------------------------

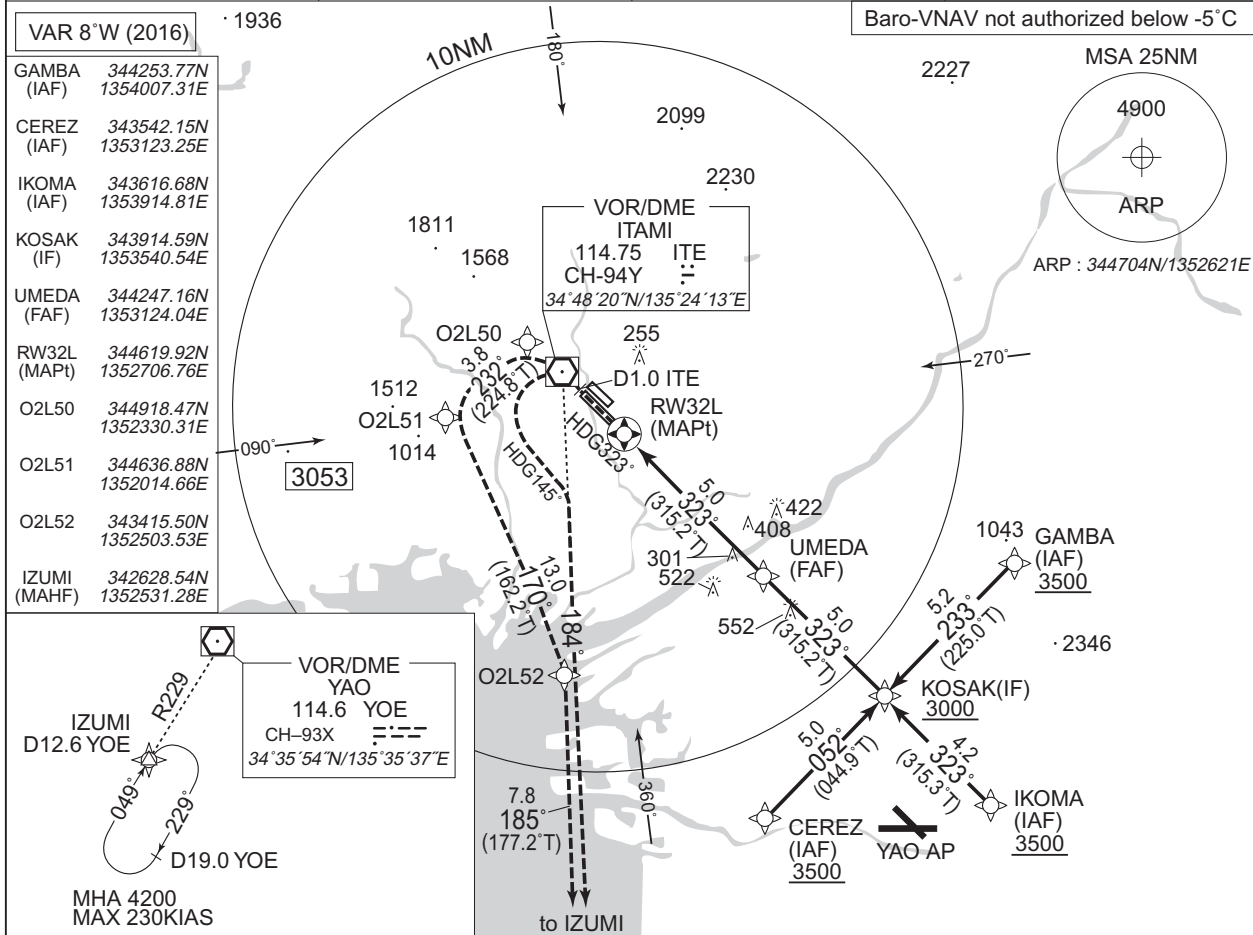

NM to Next Fix	MAPt	2	3	4	FAF
ALT(3.0° APCH Path)	-	722	1041	1359	1677

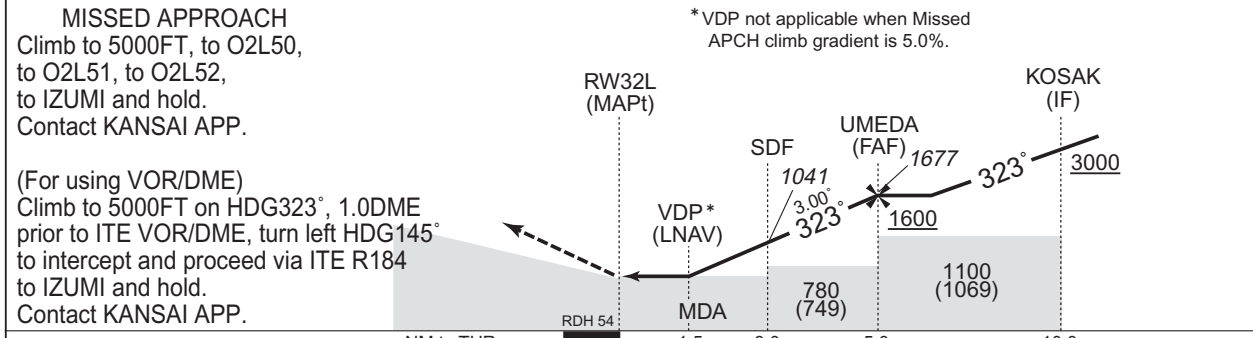

Missed APCH climb gradient MNM 6.0%							Missed APCH climb gradient MNM 5.0%						
MINIMA							MINIMA						
CAT	LNAV/VNAV		LNAV		CIRCLING		CAT	LNAV/VNAV		LNAV		CIRCLING	
	DA(H)	RVR/CMV	MDA(H)	RVR/CMV	MDA(H)			DA(H)	RVR/CMV	MDA(H)	RVR/CMV	MDA(H)	
					TOTAL AREA	WEST of RWY						TOTAL AREA	WEST of RWY
A		1400		1400	590 (551)	590 (551)	1600		1400		1400	660 (621)	660 (621)
B	530 (499)	1500	530 (499)	1500	660 (621)	610 (571)	2400	650 (619)	1500	650 (619)	1500	760 (721)	760 (721)
C		1600		1600	760 (721)	760 (721)	3200		1600		1600		
D		1800		1800					1800		1800		

JET circling to WEST side of RWY only.  
Missed APCH climb gradient of 6.0% up to 1900FT.

STANDARD ARRIVAL CHART-INSTRUMENT

RJOO / OSAKA INTL

RNAV STAR RWY32L/32R

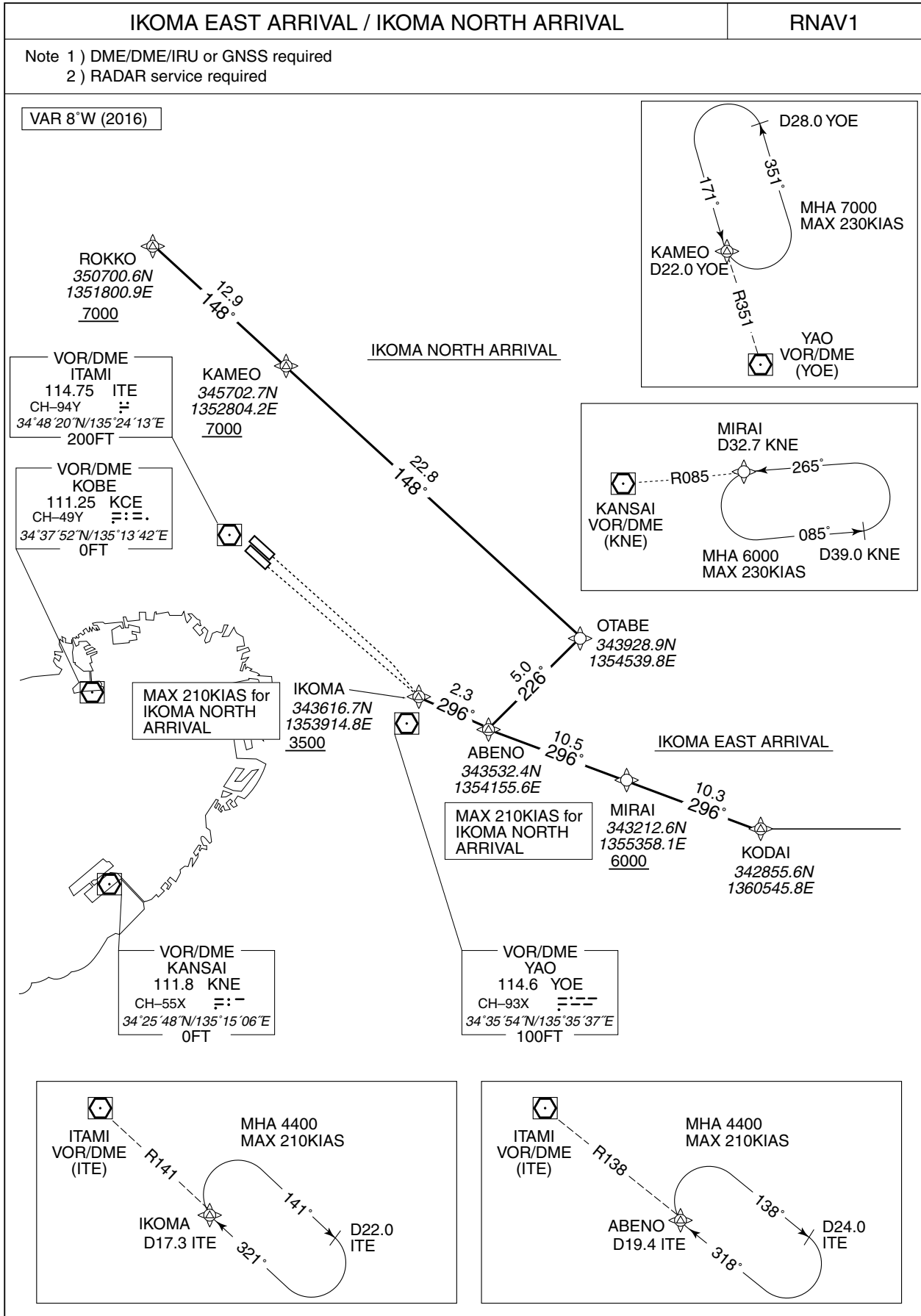

STANDARD ARRIVAL CHART-INSTRUMENT

RJOO / OSAKA INTL

RNAV STAR RWY32L/32R

IKOMA EAST ARRIVAL

From KODAI, to MIRAI at or above 6000FT, to ABENO, to IKOMA at or above 3500FT.

Critical DME	KCC : KODAI – MIRAI
DME GAP	–
Inappropriate Nav aids	See AD1.1.6.10.3. Inappropriate NAVAIDs for RNAV1

Serial Number	Path Descriptor	Waypoint Identifier	Fly Over	Course °M(°T)	Magnetic Variation	Distance (NM)	Turn Direction	Altitude (FT)	Speed (KIAS)	Vertical Angle	Navigation Specification
001	IF	KODAI	–	–	-7.6	–	–	–	–	–	RNAV1
002	TF	MIRAI	–	296 (288.7)	-7.6	10.3	–	+6000	–	–	RNAV1
003	TF	ABENO	–	296 (288.6)	-7.6	10.5	–	–	–	–	RNAV1
004	TF	IKOMA	–	296 (288.5)	-7.6	2.3	–	+3500	–	–	RNAV1

IKOMA NORTH ARRIVAL

From ROKKO at or above 7000FT, to KAMEO at or above 7000FT, to OTABE, to ABENO, to IKOMA at or above 3500FT.

Critical DME	ITE : 9.9NM to KAMEO – KAMEO YME : 19.7NM to OTABE – 13.7NM to OTABE
DME GAP	–
Inappropriate Nav aids	See AD1.1.6.10.3. Inappropriate NAVAIDs for RNAV1

Serial Number	Path Descriptor	Waypoint Identifier	Fly Over	Course °M(°T)	Magnetic Variation	Distance (NM)	Turn Direction	Altitude (FT)	Speed (KIAS)	Vertical Angle	Navigation Specification
001	IF	ROKKO	–	–	-7.6	–	–	+7000	–	–	RNAV1
002	TF	KAMEO	–	148 (140.4)	-7.6	12.9	–	+7000	–	–	RNAV1
003	TF	OTABE	–	148 (140.5)	-7.6	22.8	–	–	–	–	RNAV1
004	TF	ABENO	–	226 (218.0)	-7.6	5.0	–	–	-210	–	RNAV1
005	TF	IKOMA	–	296 (288.5)	-7.6	2.3	–	+3500	-210	–	RNAV1

STANDARD ARRIVAL CHART-INSTRUMENT

RJOO / OSAKA INTL

RNAV STAR RWY32L/32R

HABIK ARRIVAL

RNAV1

Note 1 ) DME/DME/IRU or GNSS required  
2 ) RADAR service required

VAR 8°W (2016)

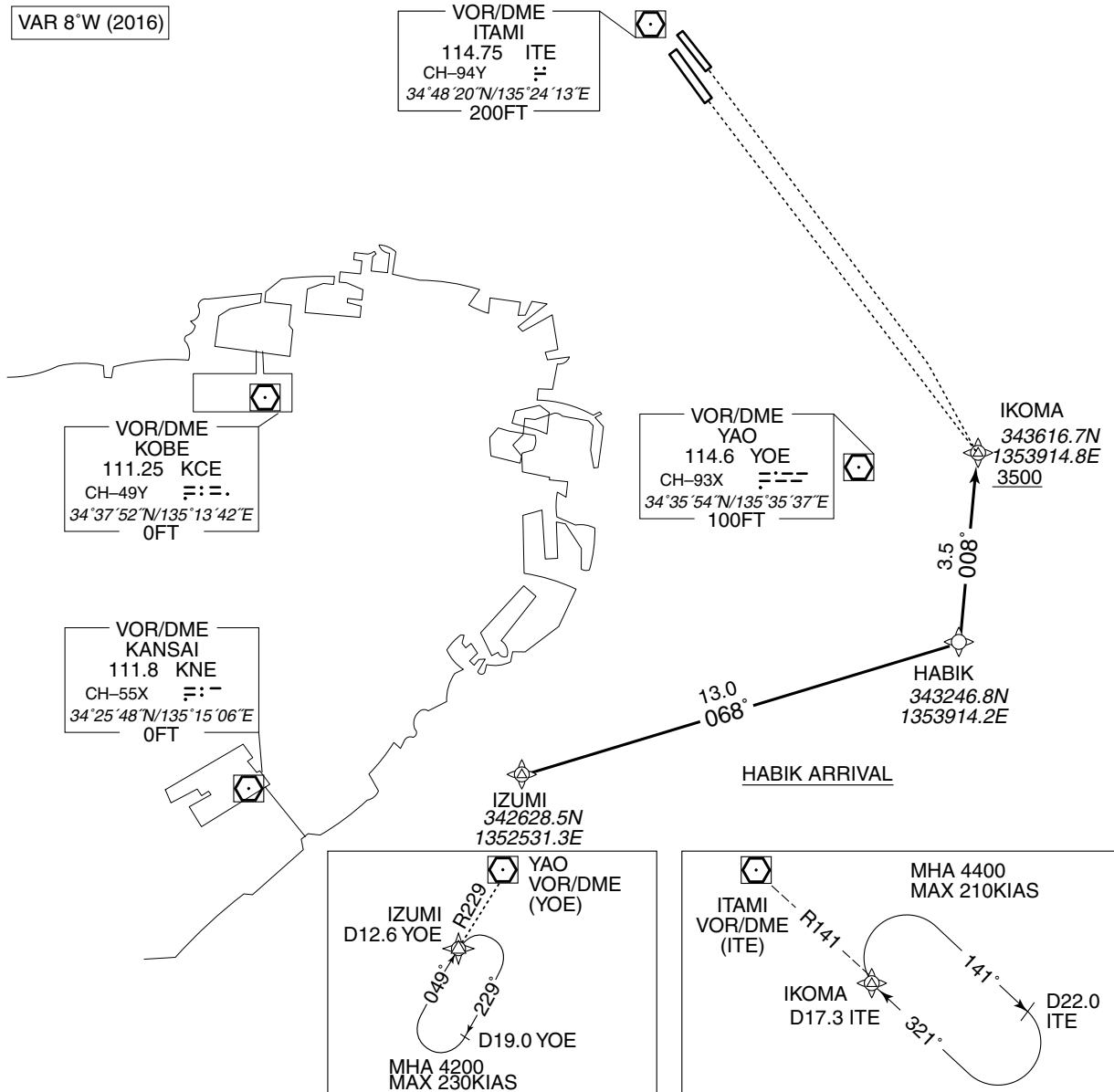

**HABIK ARRIVAL**

From IZUMI, to HABIK, to IKOMA at or above 3500FT.

Critical DME	-
DME GAP	-
Inappropriate Nav aids	See AD1.1.6.10.3. Inappropriate NAVAIDs for RNAV1

Serial Number	Path Descriptor	Waypoint Identifier	Fly Over	Course °M(°T)	Magnetic Variation	Distance (NM)	Turn Direction	Altitude (FT)	Speed (KIAS)	Vertical Angle	Navigation Specification
001	IF	IZUMI	-	-	-7.6	-	-	-	-	-	RNAV1
002	TF	HABIK	-	068 (060.8)	-7.6	13.0	-	-	-	-	RNAV1
003	TF	IKOMA	-	008 (000.1)	-7.6	3.5	-	+3500	-	-	RNAV1



RJOO / OSAKA INTL

AD CHART

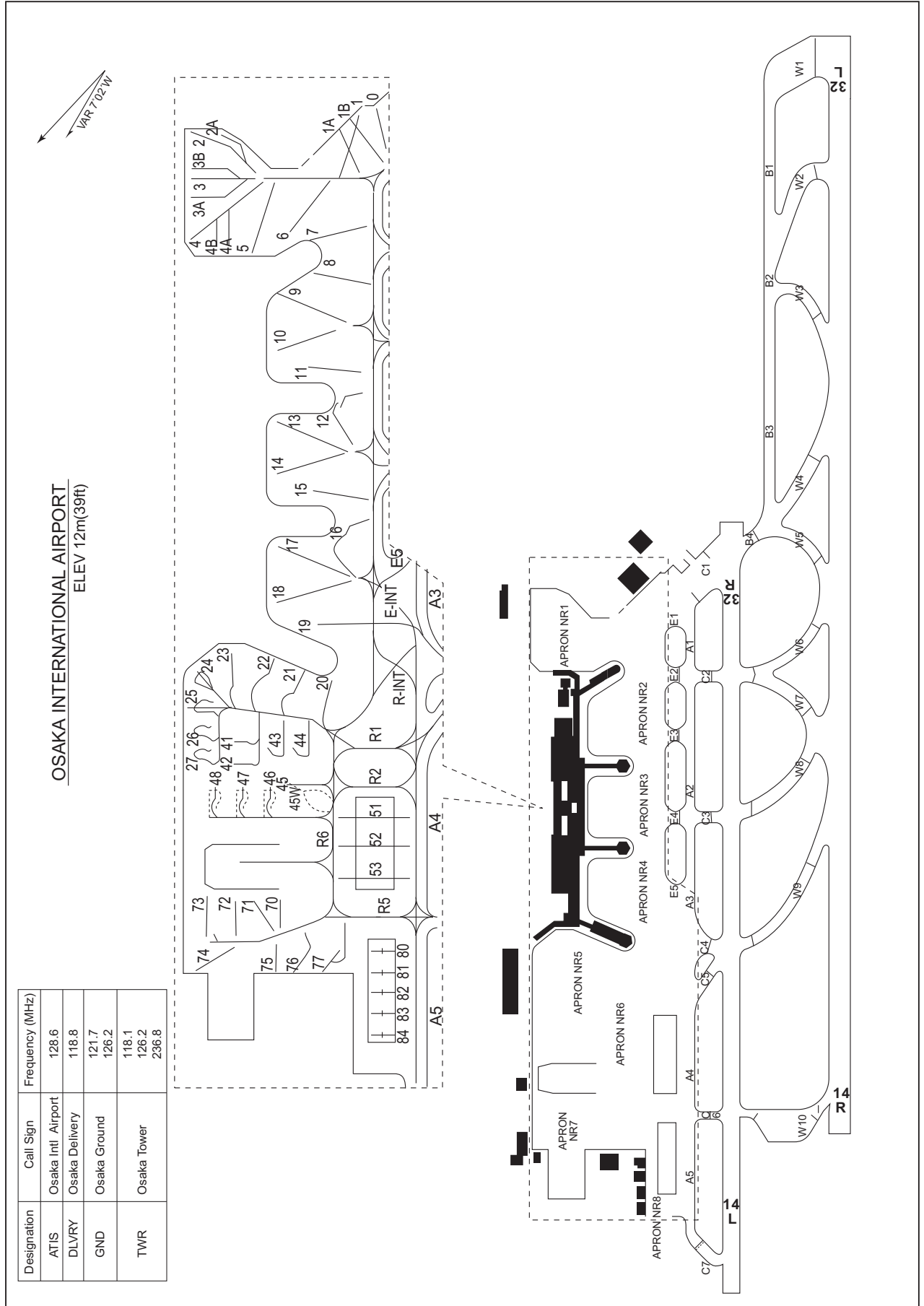

**INTENTIONALLY LEFT BLANK**

INSTRUMENT APPROACH CHART

RJOO / OSAKA INTL

ILS RWY32L

KANSAI APP 120.45 - 124.7 261.2	ILS-LOC 110.1 ISK ILS-GP 334.4 ILS-DME CH-38X	OSAKA TOWER 118.1 - 236.8 126.2 - 121.7G	RADAR AVBL ATIS 128.6
---------------------------------------	--	--	--------------------------

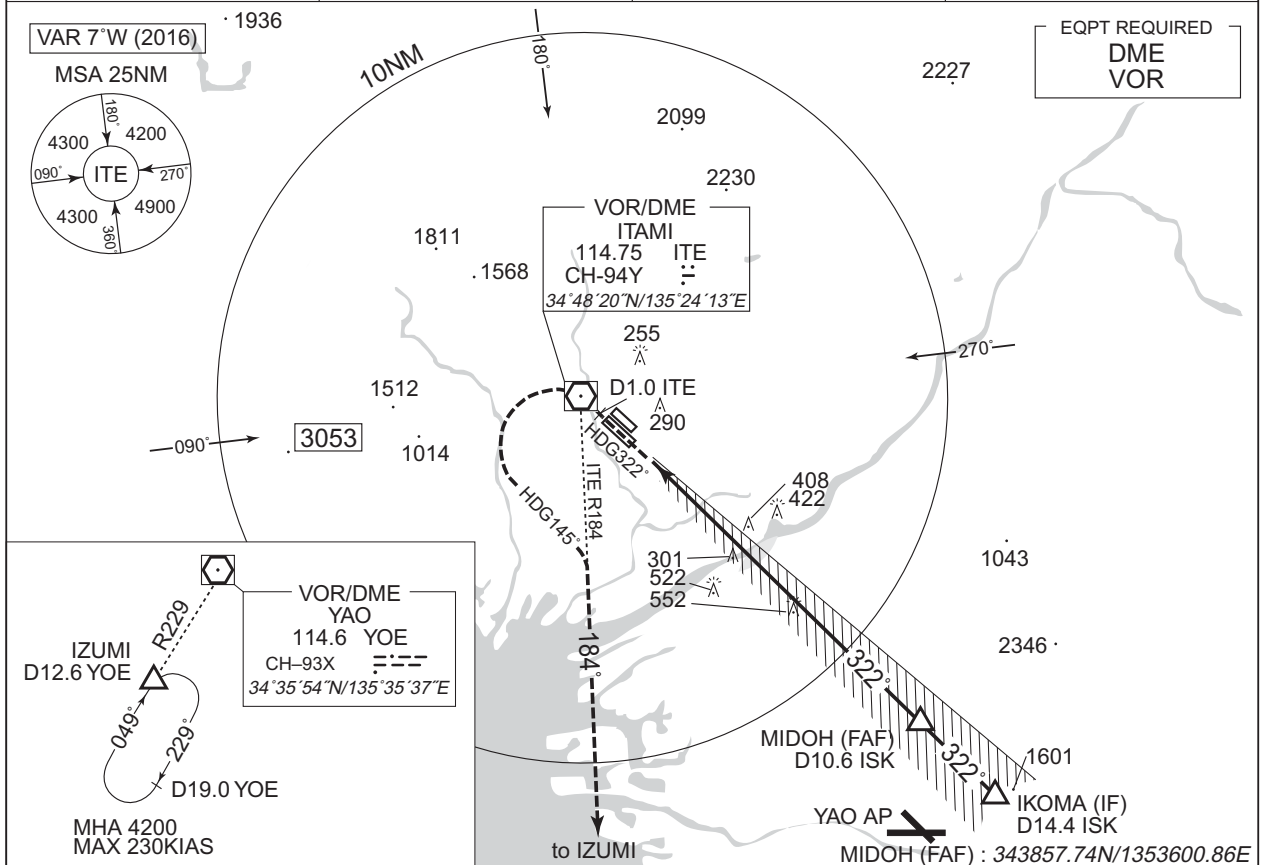

MISSED APPROACH

Climb to 5000FT on HDG322°, 1.0DME prior to ITE VOR/DME, turn left HDG145° to intercept and proceed via ITE R184 to IZUMI and hold.  
Contact KANSAI APP.

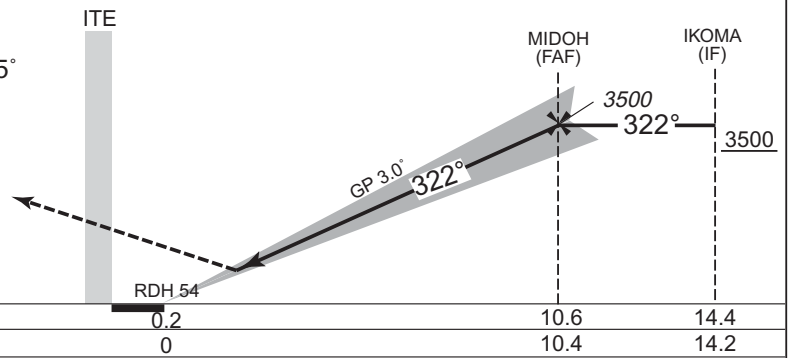

Missed APCH climb gradient MNM 4.0%

MINIMA		THR elev. 31		AD elev. 39		
CAT	CAT I		CIRCLING			
	DA(H)	RVR/CMV	MDA(H)		VIS	
A	281 (250)	700	TOTAL AREA	WEST of RWY		1600
B			590 (551)	590 (551)		
C			660 (621)	610 (571)	2400	
D			760 (721)	760 (721)	3200	

MINIMA with Missed APCH climb gradient of 2.5% are not established.  
JET circling to WEST side of RWY only.

INSTRUMENT APPROACH CHART

RJOO / OSAKA INTL

LOC RWY32L

KANSAI APP 120.45 - 124.7 261.2	ILS - LOC 110.1 ISK ILS-DME CH-38X	OSAKA TOWER 118.1 - 236.8 126.2 - 121.7G	RADAR AVBL ATIS 128.6
---------------------------------------	--	--	--------------------------

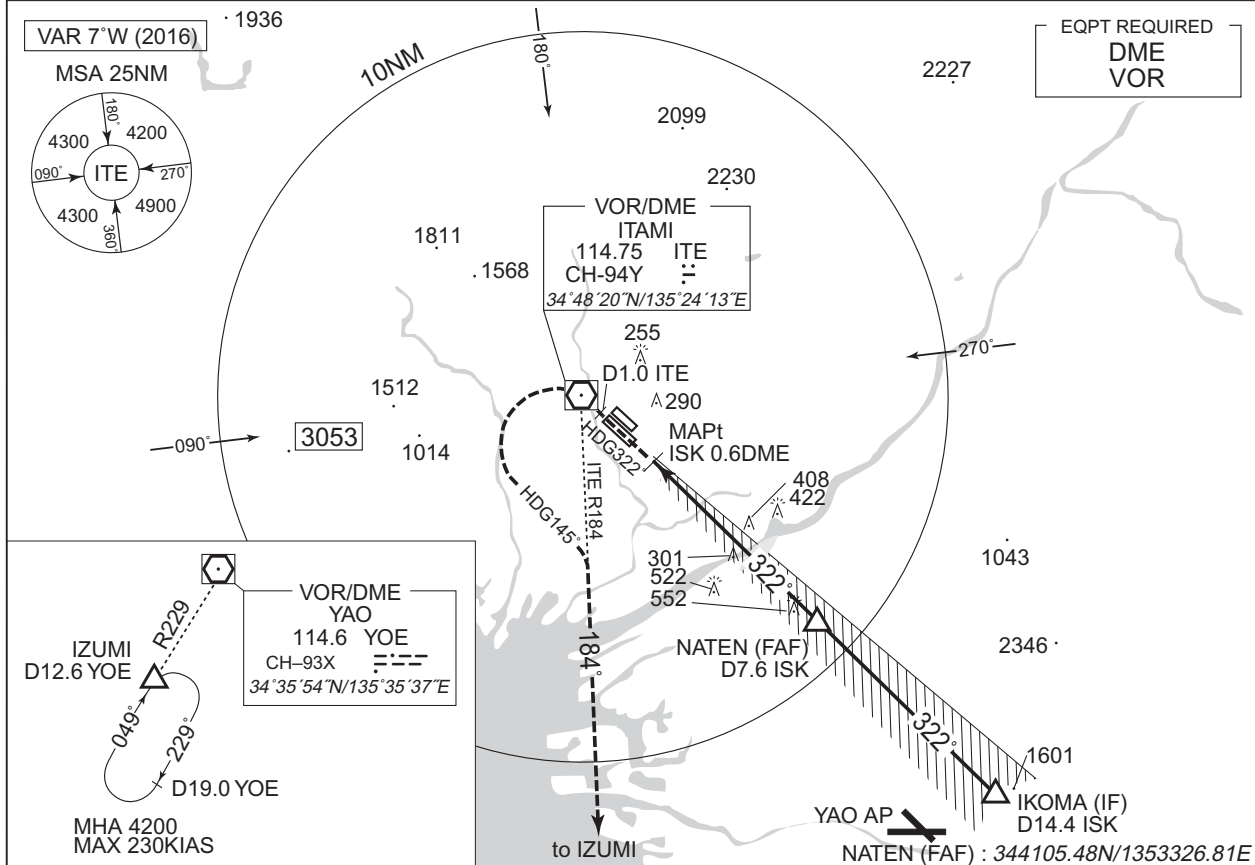

	NM to ISK	MAPt	2	3	4	5	6	7	FAF
	ALT (3.0° APCH Path)	-	660	978	1297	1615	1934	2252	2433

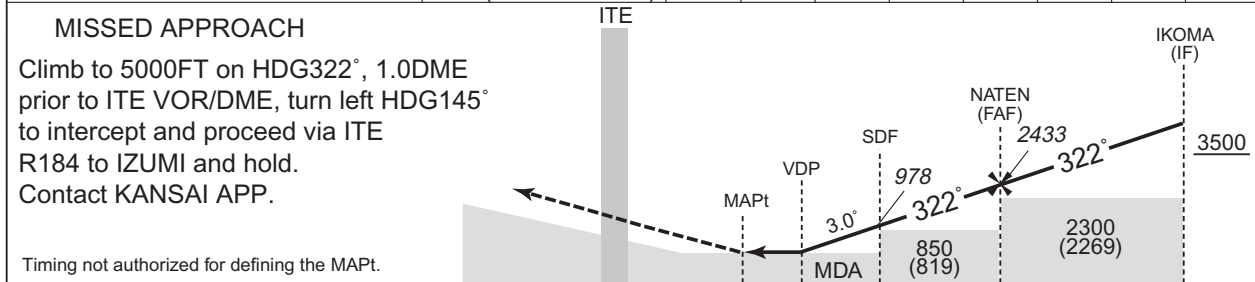

	DME to ISK	0.2	0.6	1.2	3.0	7.6	14.4
	NM to THR	0	0.5	1.0	2.8	7.4	14.2

Missed APCH climb gradient MNM 3.2%

MINIMA		THR elev. 31	AD elev. 39		
CAT	MDA(H)	RVR/ CMV	CIRCLING		VIS
			TOTAL AREA	WEST of RWY	
A	390 (359)	1200	590 (551)	590 (551)	1600
B		1300			
C		1400	660 (621)	610 (571)	2400
D		1600	760 (721)	760 (721)	3200

MINIMA with Missed APCH climb gradient of 2.5% are not established. JET circling to WEST side of RWY only.

INSTRUMENT APPROACH CHART

RJOO / OSAKA INTL

RNAV(GNSS) RWY32R

KANSAI APP 120.45 - 124.7 261.2	1. DME/DME not authorized. 2. RADAR service required. 3. GNSS required.	OSAKA TOWER 118.1 - 236.8 126.2 - 121.7G	RADAR AVBL ATIS 128.6
---------------------------------------	---	--	--------------------------

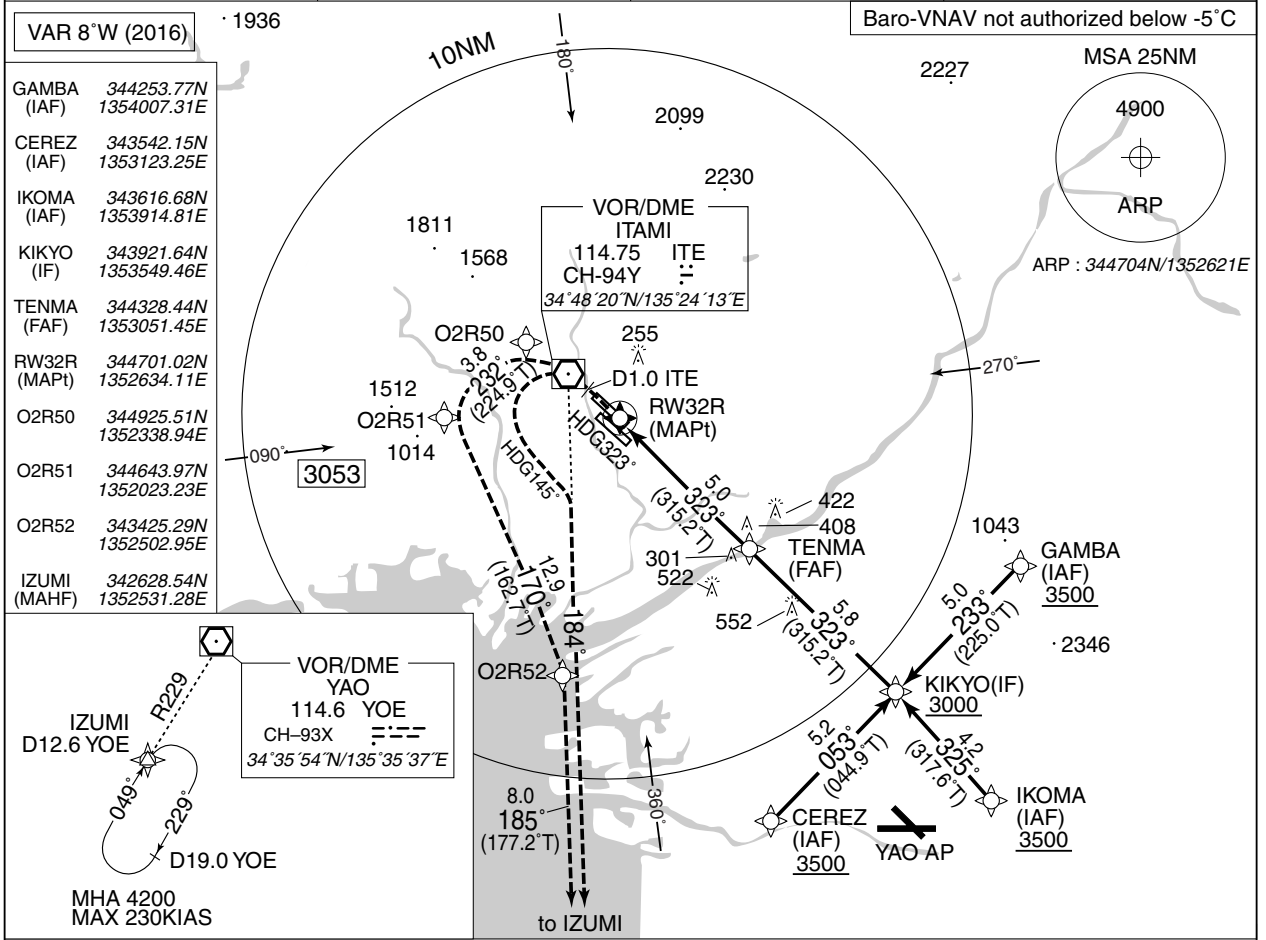

NM to Next Fix	MAPt	2	3	4	FAF
ALT(3.0° APCH Path)	-	722	1040	1359	1677

**MISSED APPROACH**  
Climb to 5000FT, to O2R50, to O2R51, to O2R52, to IZUMI and hold. Contact KANSAI APP.

(For using VOR/DME)  
Climb to 5000FT on HDG323°, 1.0DME prior to ITE VOR/DME, turn left HDG145° to intercept and proceed via ITE R184 to IZUMI and hold. Contact KANSAI APP.

\*VDP not applicable when Missed APCH climb gradient is 5.0%.

Missed APCH climb gradient MNM 6.0%						
MINIMA			THR elev. 35		AD elev. 39	
CAT	LNAV/VNAV		LNAV		CIRCLING	
	DA(H)	RVR/CMV	MDA(H)	RVR/CMV	MDA(H)	VIS
A	530 (495)	1400	530 (491)	1400	570 (531)	1600
B		1500		1600		
C		1600			1800	
D		1800		760 (721)		3200

Circling to WEST side of RWY only.  
Missed APCH climb gradient of 6.0% up to 1900FT.

Missed APCH climb gradient MNM 5.0%						
MINIMA			THR elev. 35		AD elev. 39	
CAT	LNAV/VNAV		LNAV		CIRCLING	
	DA(H)	RVR/CMV	MDA(H)	RVR/CMV	MDA(H)	VIS
A	820 (785)	1500	820 (781)	1500	820 (781)	1600
B		1800		1800		
C		1800			2000	
D		2000		2000		3200

Circling to WEST side of RWY only.

**INTENTIONALLY LEFT BLANK**

INSTRUMENT APPROACH CHART

RJOO / OSAKA INTL

VOR A

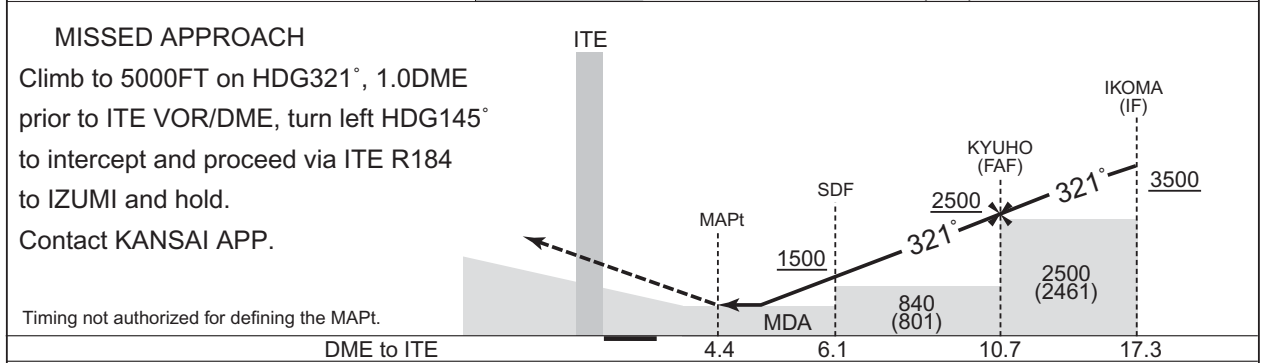
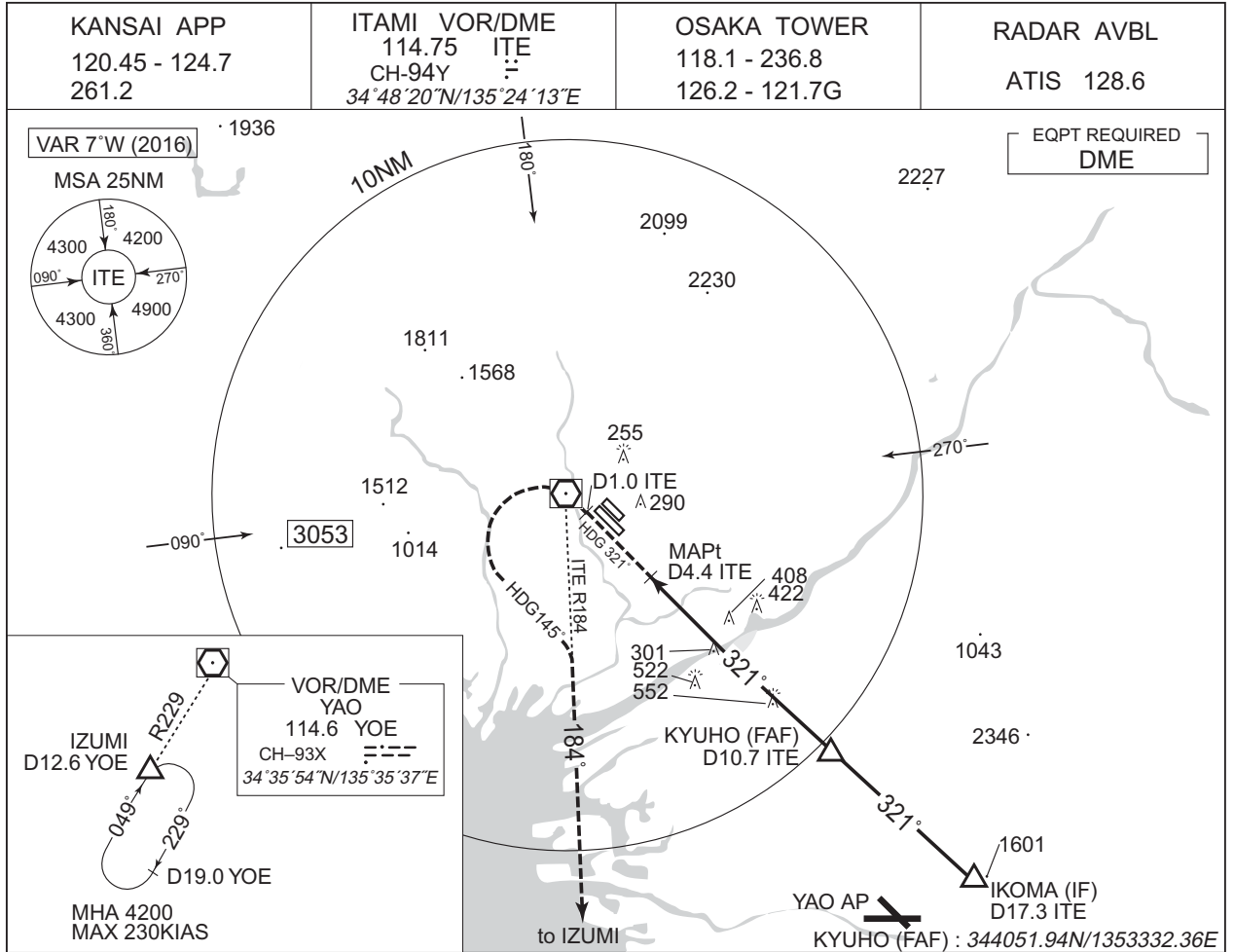

MINIMA		AD elev. 39	
CAT	CIRCLING		VIS
	MDA(H)		
	TOTAL AREA	WEST of RWY	
A	590 (551)	590 (551)	1600
B	590 (551)	590 (551)	1600
C	660 (621)	610 (571)	2400
D	760 (721)	760 (721)	3200

JET circling to WEST side of RWY only.

RJOO / OSAKA INTL

OSAKA Visual REP



Call sign	BRG / DIST from ARP	Remarks
刀根山 Toneyama	044°/1.3NM	中国豊中インターチェンジ interchange
千里 Senri	070°/3.0NM	千里ジャンクション Junction
吹田 Suita	082°/5.4NM	吹田インターチェンジ interchange
鳥飼 Torikai	110°/6.8NM	鳥飼大橋 Bridge
鳴尾 Naruo	232°/5.4NM	甲子園球場 Baseball ground
伊丹 Itami	263°/0.9NM	JR伊丹駅 Station
川西 Kawanishi	345°/5.0NM	多田神社 Shrine
石橋 Ishibashi	020°/1.5NM	阪急石橋阪大前駅 Station



RJOO / OSAKA INTL

LDG CHART

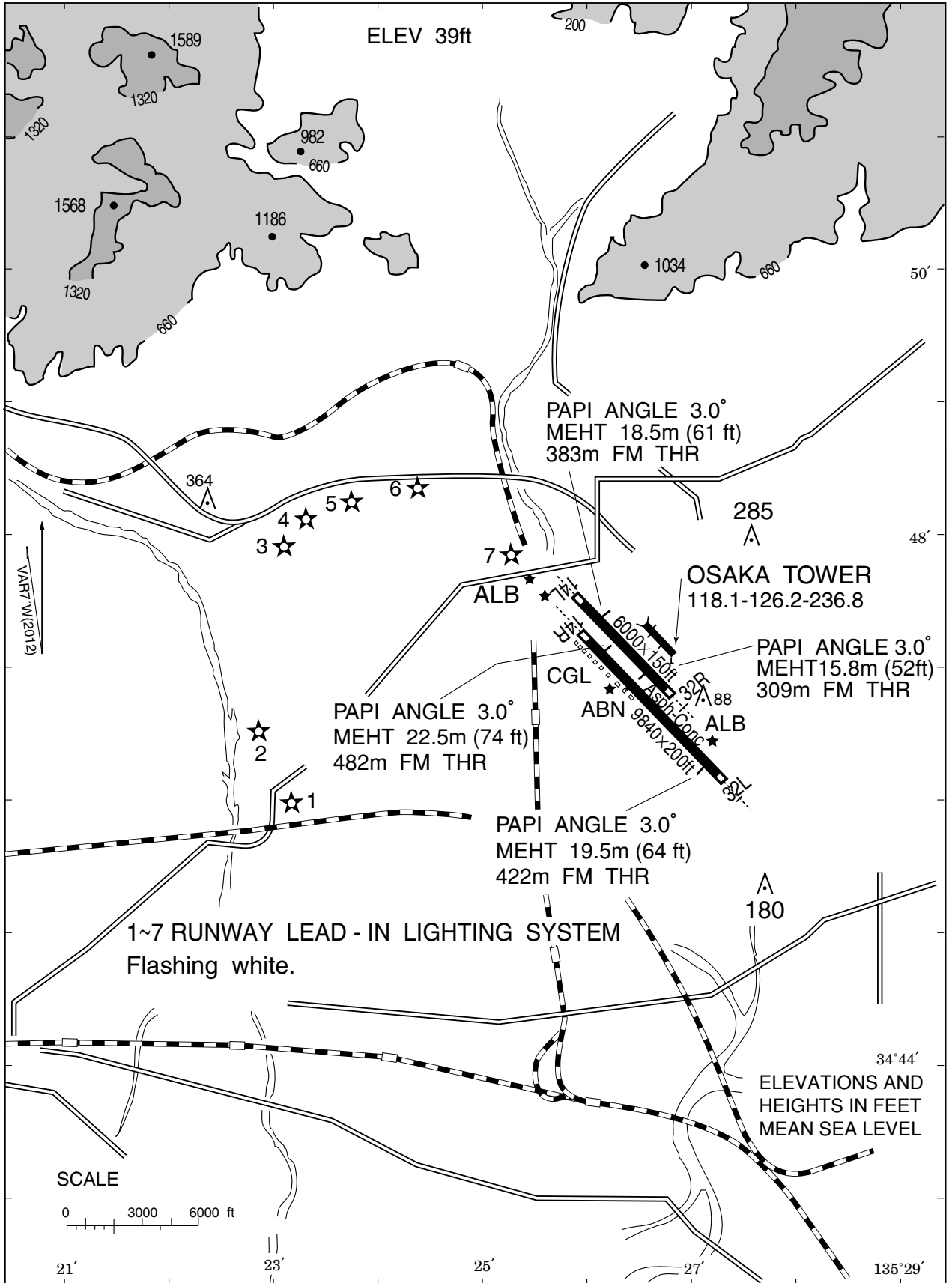

RJOO / OSAKA INTL

HLDG PATTERN

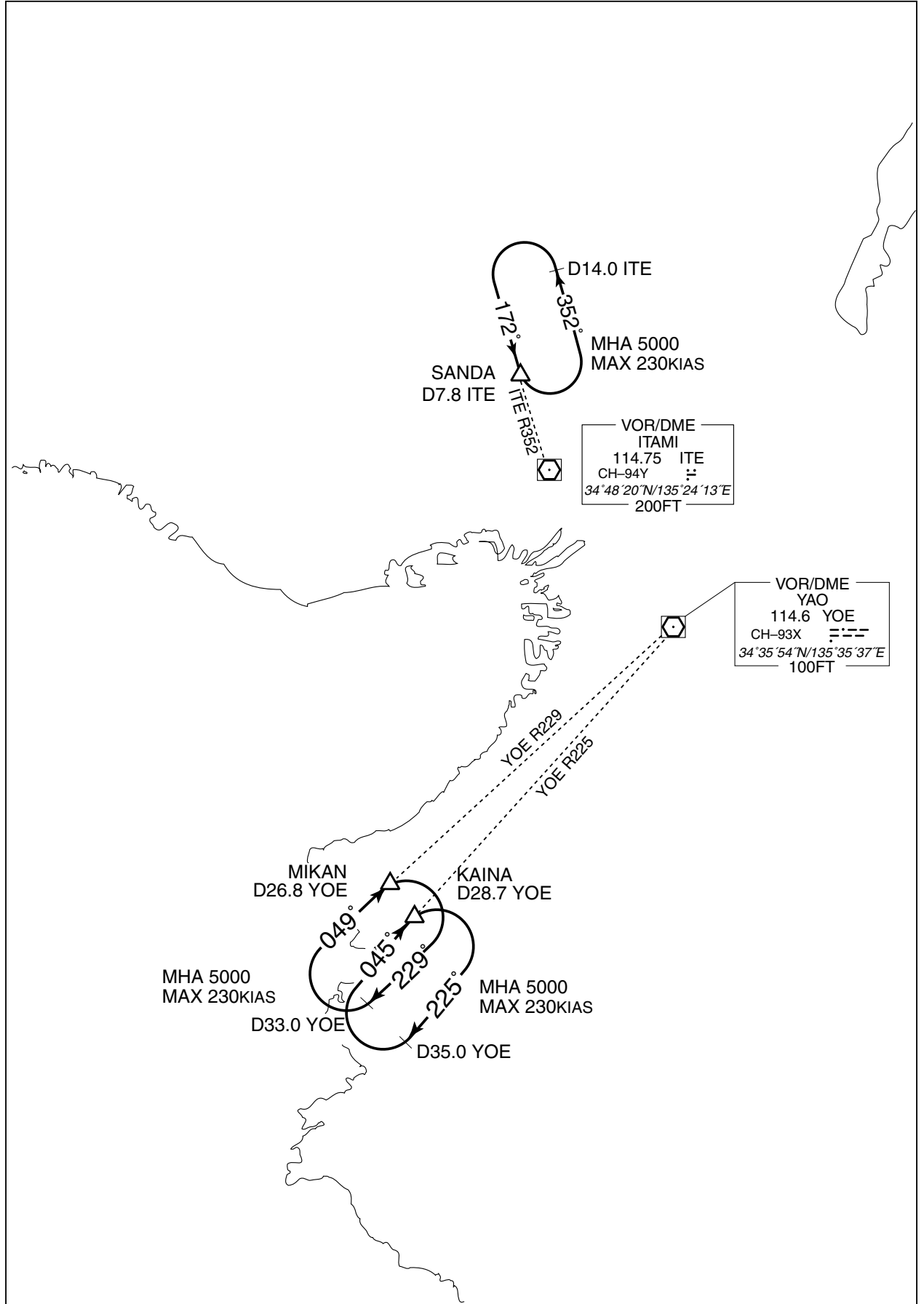

RJOO / OSAKA INTL

Minimum Vectoring Altitude CHART

VAR 7°W (2011)

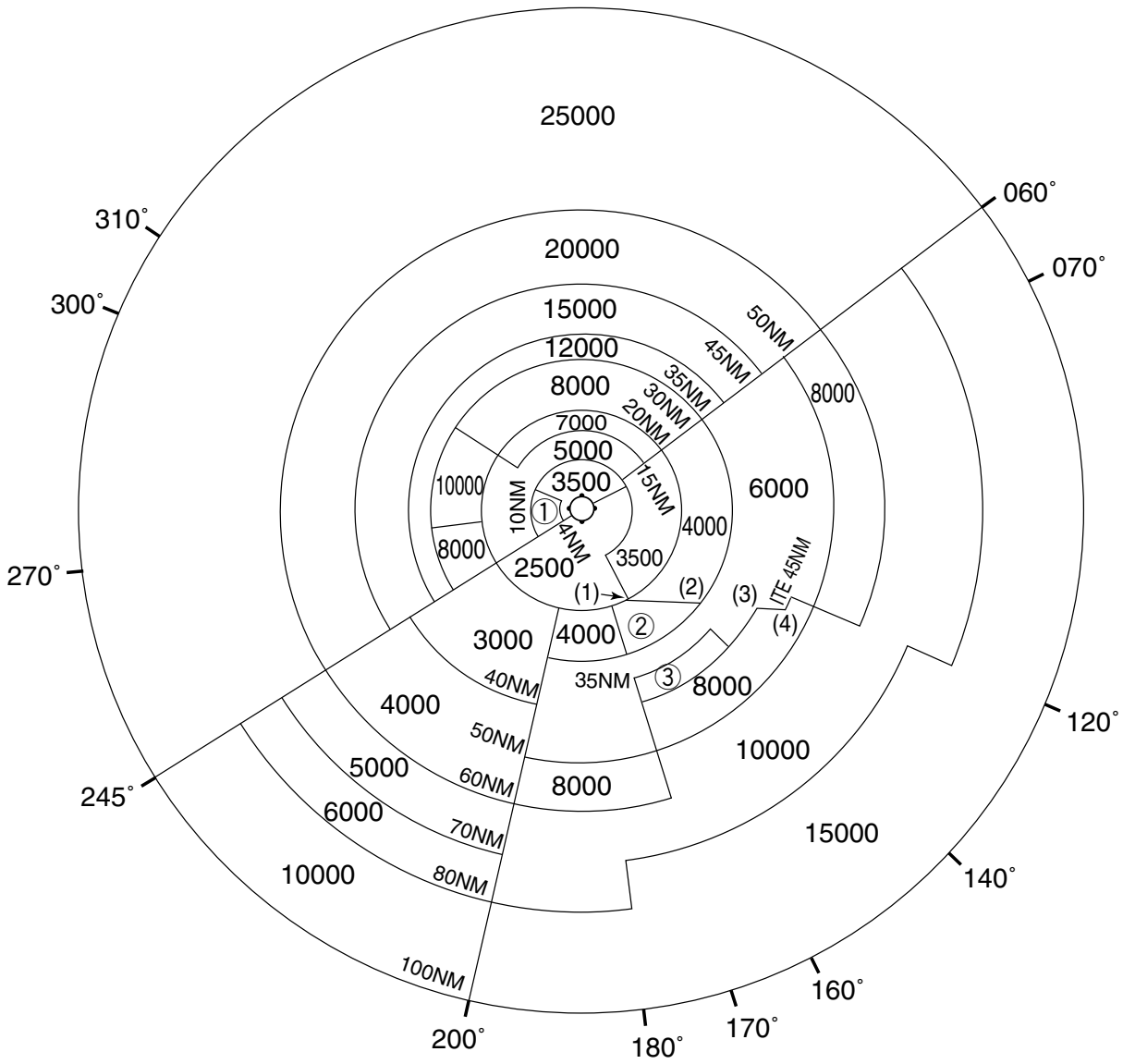

- ① 4500 (1) 342930N/1353527E
- ② 5000 (2) 342925N/1355432E
- ③ 7000 (3) 342918N/1360849E
- (4) 342924N/1361335E

CENTER : 344752N/1352550E (No.1 RADAR SITE)  
CENTER : 344659N/1352600E (No.2 RADAR SITE)

AERODROME OBSTACLE CHART-ICAO  
TYPE A (OPERATING LIMITATIONS)

DIMENSIONS AND ELEVATIONS IN FEET BEARINGS ARE MAGNETIC

MAGNETIC VARIATION 8° W-FEB 2017

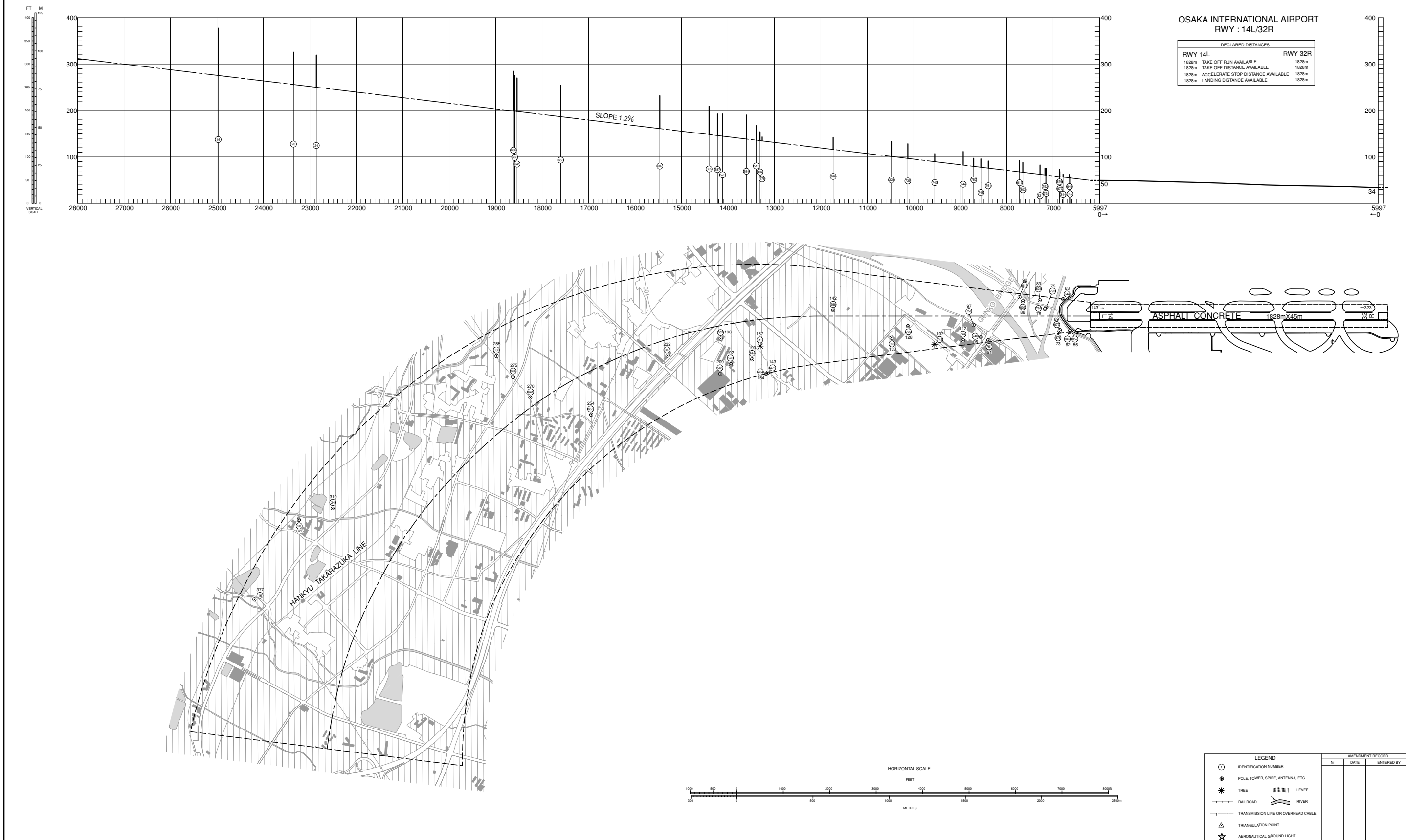

AERODROME OBSTACLE CHART-ICAO  
TYPE A (OPERATING LIMITATIONS)

DIMENSIONS AND ELEVATIONS IN FEET BEARINGS ARE MAGNETIC

MAGNETIC VARIATION 8° W-FEB 2017

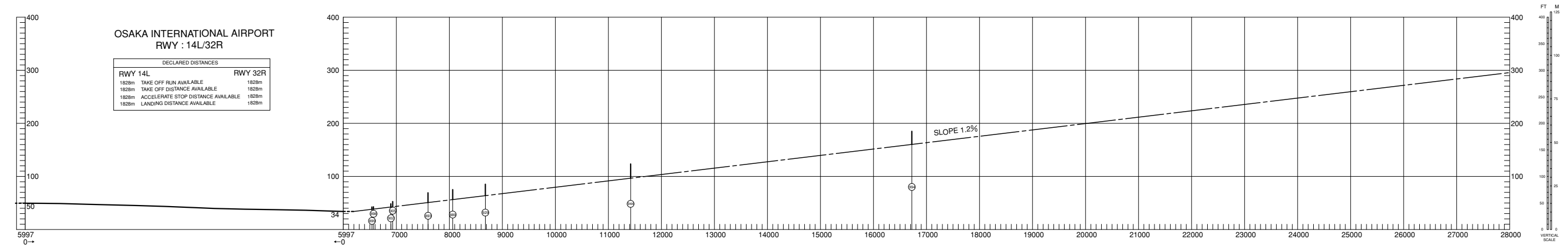

OSAKA INTERNATIONAL AIRPORT  
RWY : 14L/32R

DECLARED DISTANCES	
RWY 14L	RWY 32R
1828m TAKE OFF RUN AVAILABLE	1828m
1828m TAKE OFF DISTANCE AVAILABLE	1828m
1828m ACCELERATE STOP DISTANCE AVAILABLE	1828m
1828m LANDING DISTANCE AVAILABLE	1828m

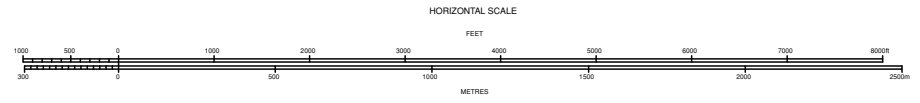
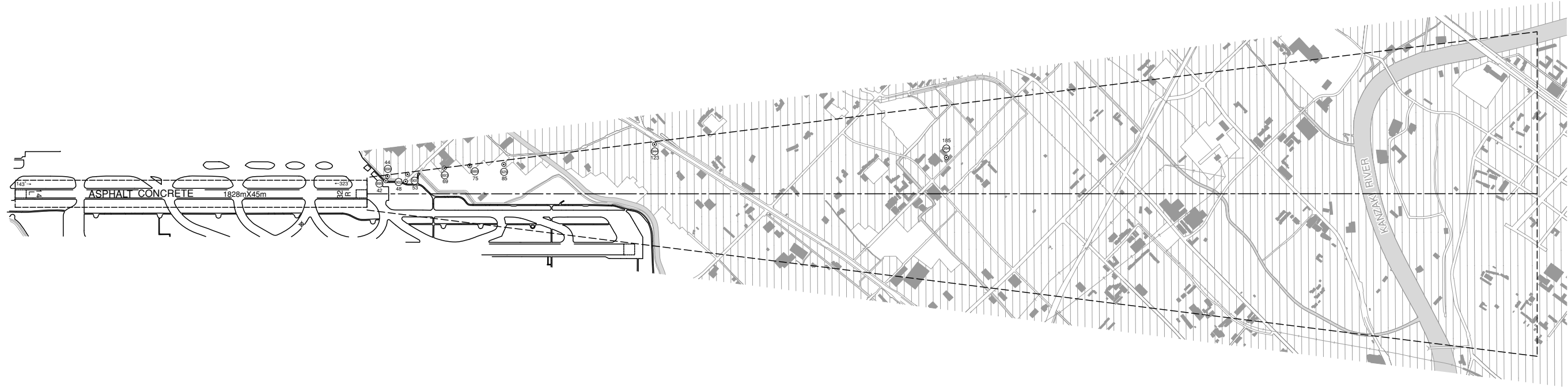

LEGEND		AMENDMENT RECORD		
		No.	DATE	ENTERED BY
○	IDENTIFICATION NUMBER			
●	POLE, TOWER, SPIRE, ANTENNA, ETC			
*	TREE			
▬	RAILROAD			
— — —	TRANSMISSION LINE OR OVERHEAD CABLE			
△	TRANSLUCATION POINT			
☆	AERONAUTICAL GROUND LIGHT			

AERODROME OBSTACLE CHART-ICAO  
TYPE A (OPERATING LIMITATIONS)

DIMENSIONS AND ELEVATIONS IN FEET BEARINGS ARE MAGNETIC

MAGNETIC VARIATION 8° W-FEB 2017

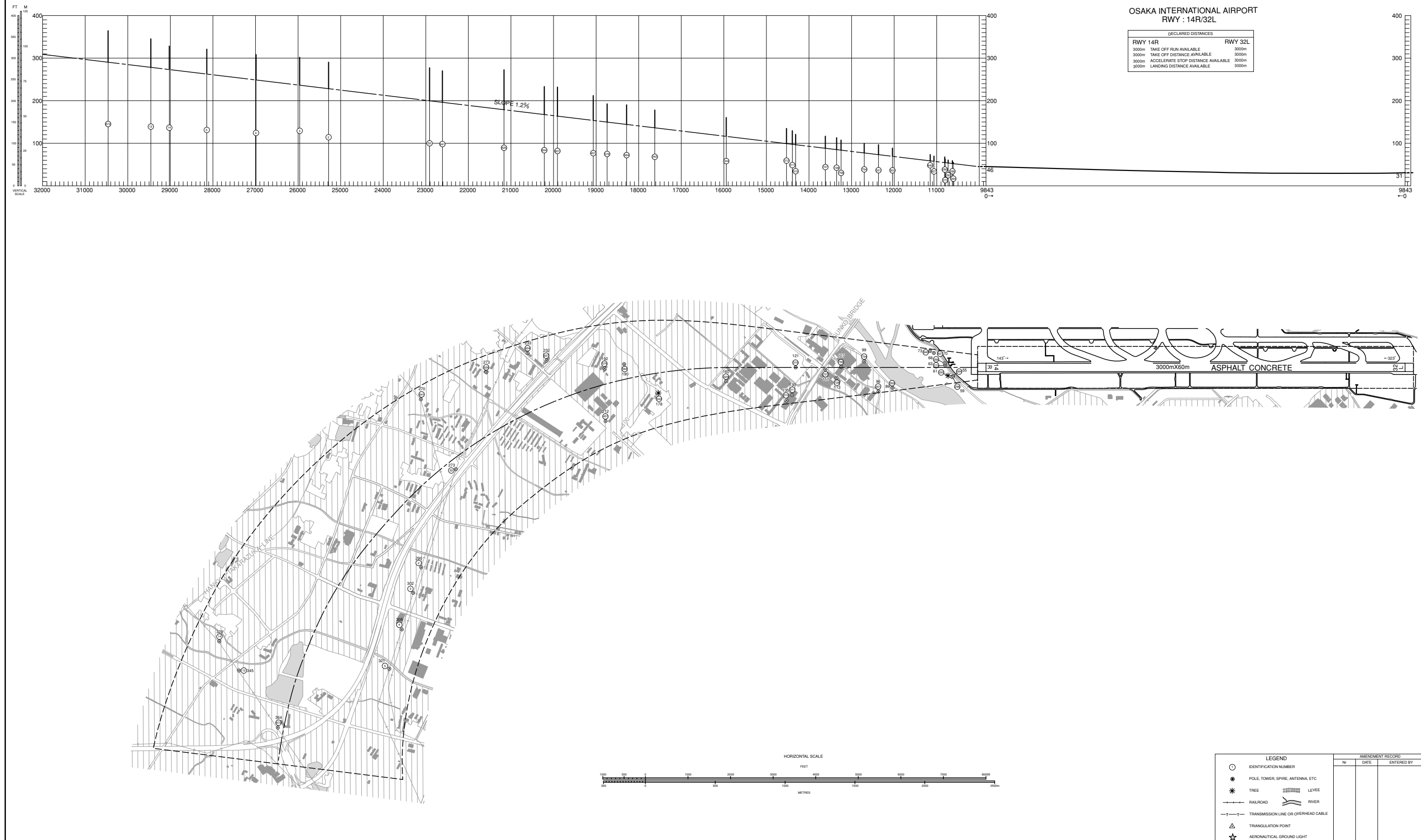

AERODROME OBSTACLE CHART-ICAO  
TYPE A (OPERATING LIMITATIONS)

DIMENSIONS AND ELEVATIONS IN FEET BEARINGS ARE MAGNETIC

MAGNETIC VARIATION 8° W-FEB 2017

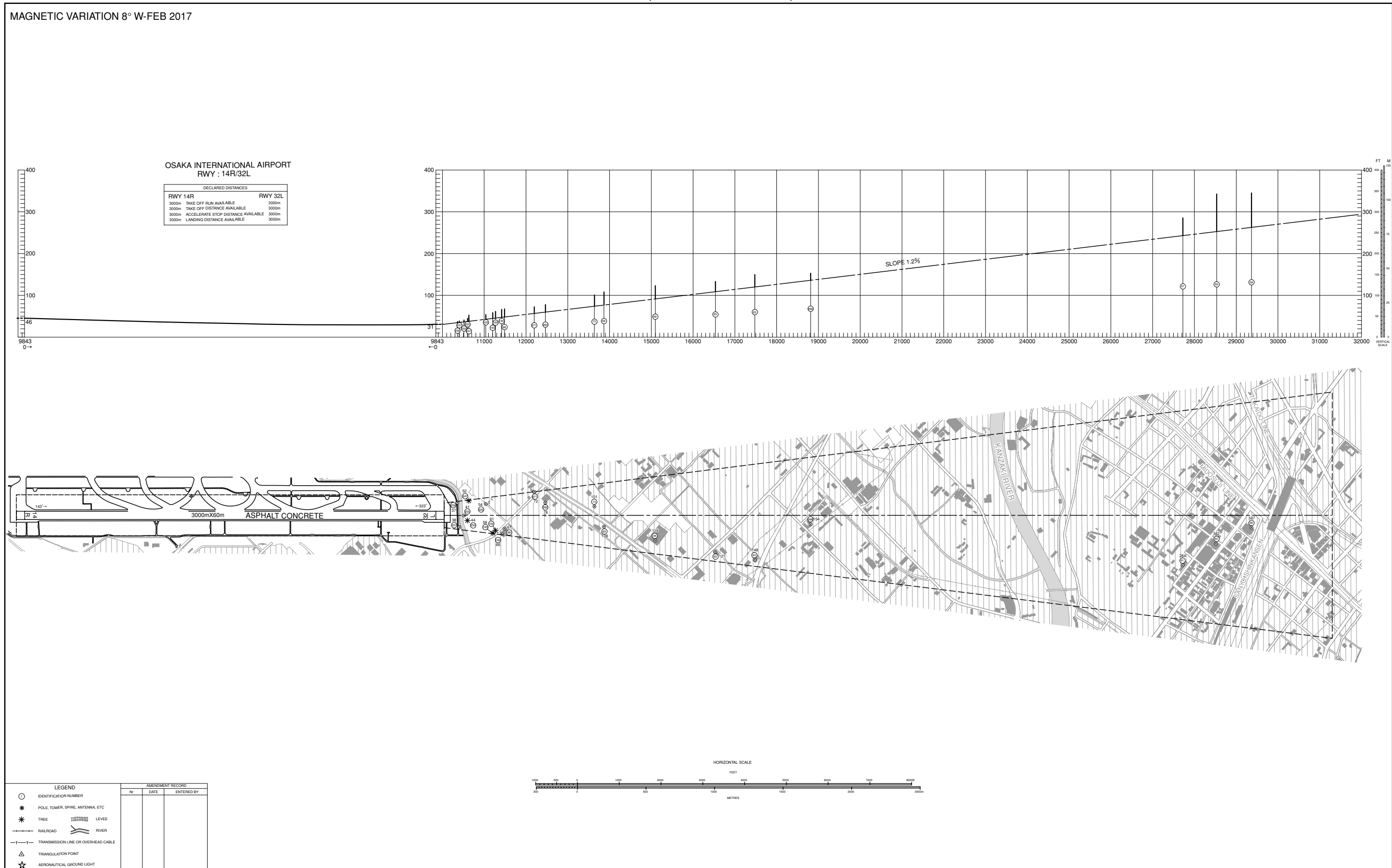

AERODROME OBSTACLE CHART-ICAO  
TYPE B

DIMENSIONS AND ELEVATIONS IN FEET BEARINGS ARE MAGNETIC

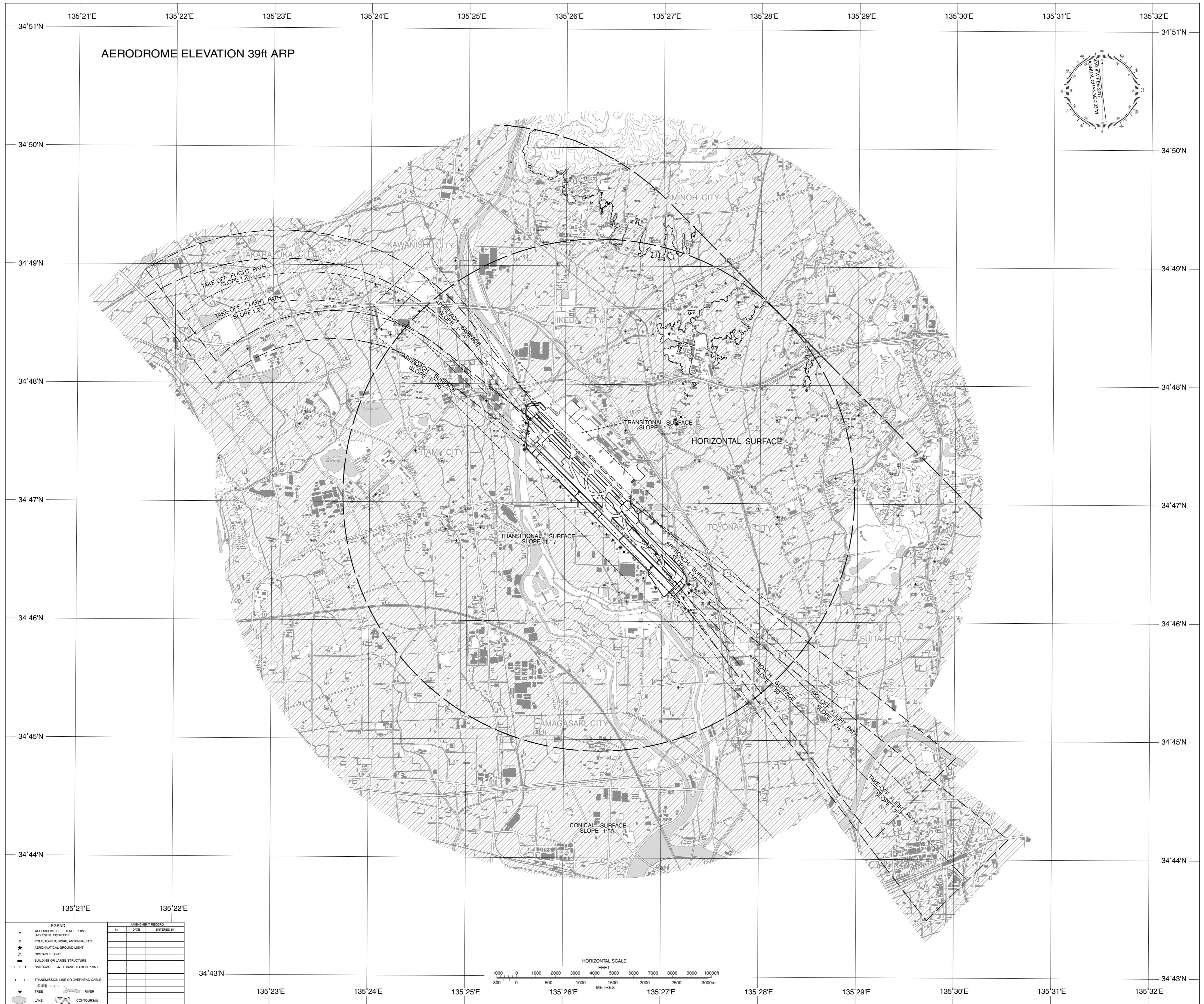



STANDARD DEPARTURE CHART -INSTRUMENT

RJOO / OSAKA INTL

SID

ASUKA FOUR DEPARTURE

RWY 32R/32L : Climb RWY HDG to 500FT or above, turn left within 4NM from RWY end/ITE 2.1DME,...

RWY 14R/14L : Climb RWY HDG to 500FT or above, turn left, ...via ITE R101 to ASUKA.

Cross ASUKA at or above 5000FT.

Note : When take off RWY 14R/14L, following climb gradient should be maintained until 500FT.

Speed (Knots)	60	90	120	150	180	210
Rate (Feet/Min)	300	450	600	750	900	1050

PANAS ONE DEPARTURE

RWY 32R/32L : Climb RWY HDG to 500FT or above, turn left within 4NM from RWY end/ITE 2.1DME,...

RWY 14R/14L : Climb RWY HDG to 500FT or above, turn left, ...via ITE R101 to PANAS.

Note : When take off RWY 14R/14L, following climb gradient should be maintained until 500FT.

Speed (Knots)	60	90	120	150	180	210
Rate (Feet/Min)	300	450	600	750	900	1050

CHANGE: New PROC(PANAS ONE DEPARTURE).

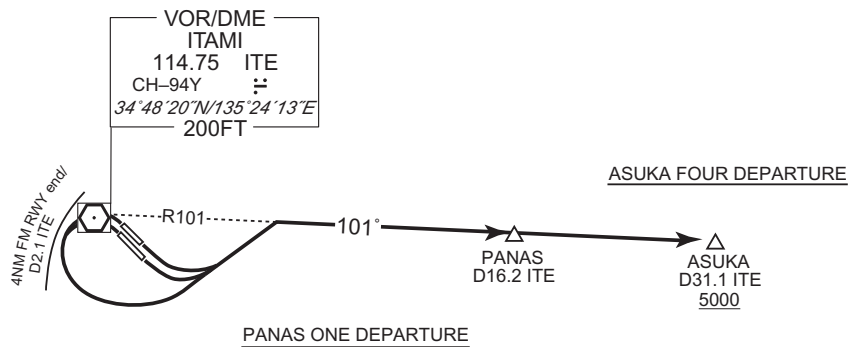

STANDARD DEPARTURE CHART -INSTRUMENT

RJOO / OSAKA INTL

RNAV TRANSITION

KOMAZ TRANSITION		RNAV1
Note 1 ) DME/DME/IRU or GNSS required. 2 ) RADAR service required.	Critical DME	-
	DME GAP	-
	Inappropriate Nav aids	See AD1.1.6.10.3. Inappropriate NAVAIDs for RNAV1

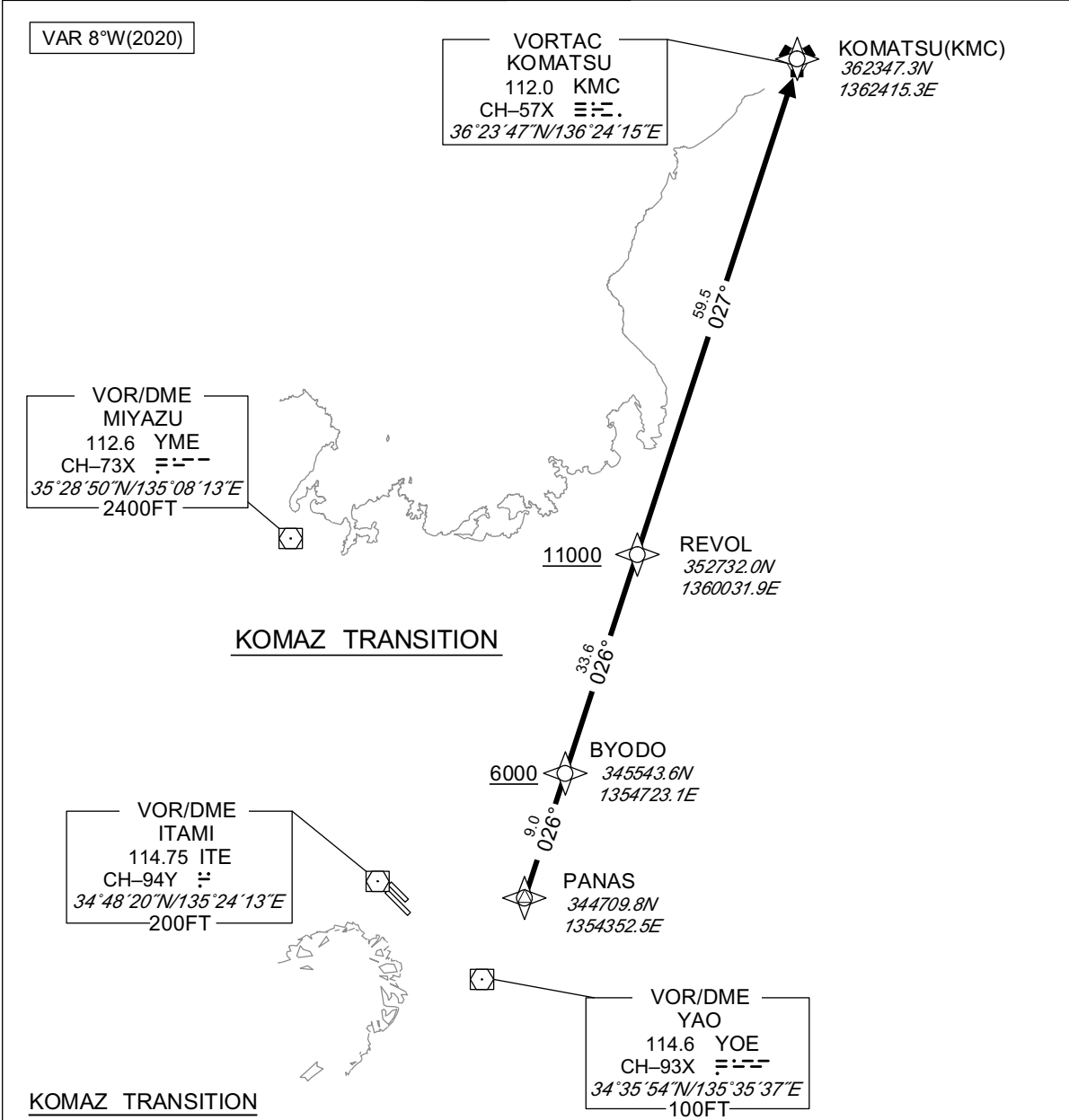

KOMAZ TRANSITION

From PANAS, to BYODO at or above 6000FT, to REVOL at or above 11000FT, to KMC.

Serial Number	Path Descriptor	Waypoint Identifier	Fly Over	Course °M(°T)	Magnetic Variation	Distance (NM)	Turn Direction	Altitude (FT)	Speed (KIAS)	Vertical Angle	Navigation Specification
001	IF	PANAS	-	-	-7.9	-	-	-	-	-	RNAV1
002	TF	BYODO	-	026 (018.6)	-7.9	9.0	-	+6000	-	-	RNAV1
003	TF	REVOL	-	026 (018.6)	-7.9	33.6	-	+11000	-	-	RNAV1
004	TF	KMC	-	027 (018.7)	-7.9	59.5	-	-	-	-	RNAV1

CHANGE: New PROC.

# Airspace for the advisory service concerning low level wind shear

UPPER LIMIT: 1600ft above FIELD ELEV LEVEL  
LOWER LIMIT: FIELD ELEV LEVEL

FIELD ELEV 39ft

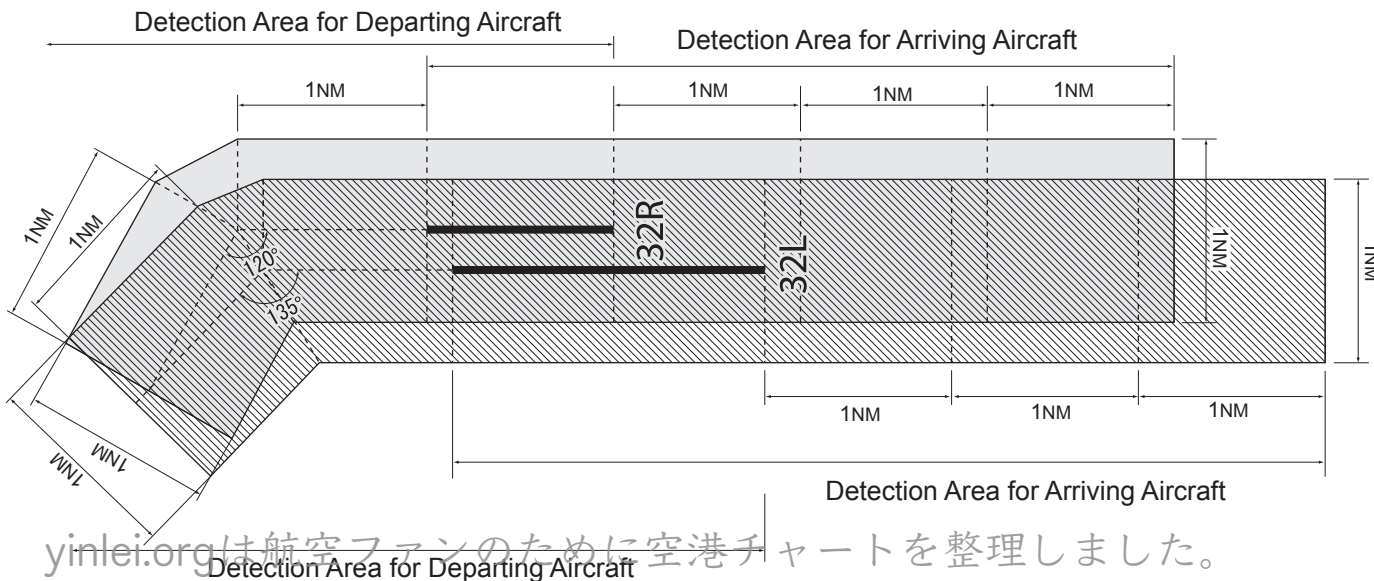
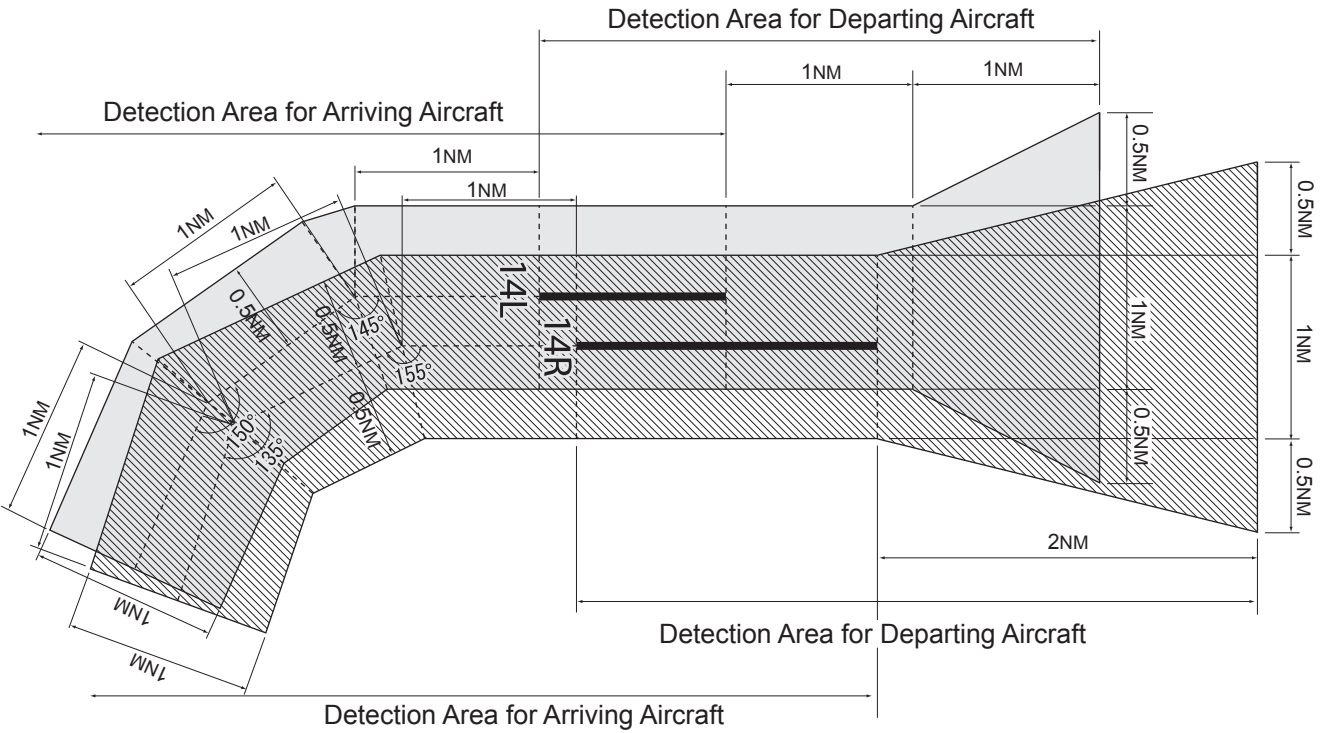

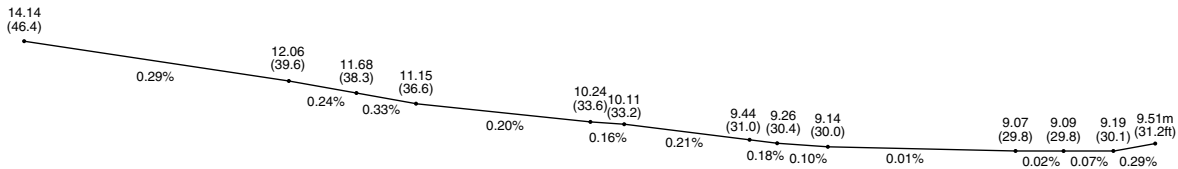

14R

32L

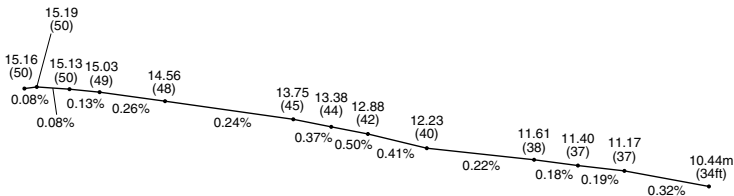
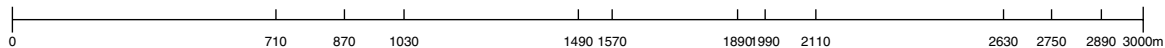

14L

32R

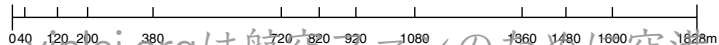

Runway lead-in lighting system for RWY 14 side  
(Nr.1 to Nr.7, Flashing white)

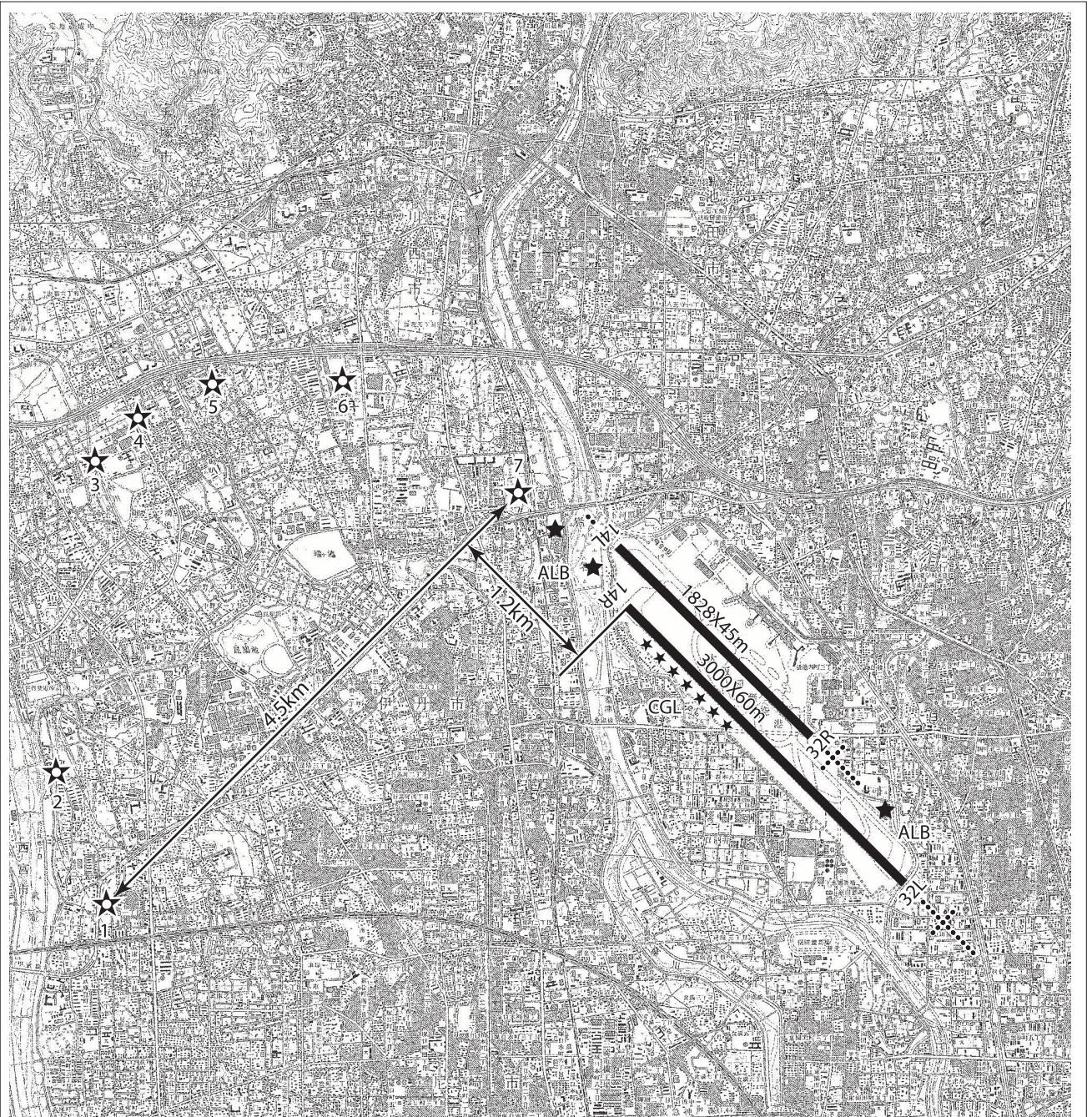

## Usable area of PAPI

Usable area of PAPI for Runway 14L and Runway 14R is within approximately 2.4NM from Runway 14L threshold and approximately 2.6NM from Runway 14R threshold(Hankyu Railway, Takarazuka Line) due to obstruction (mountain).

滑走路14L末端側及び14R末端側進入角指示灯（PAPI）の使用範囲は、障害物（山）のため滑走路14L末端及び14R末端からそれぞれ2.4NM及び2.6NM（阪急宝塚線）以内とする。

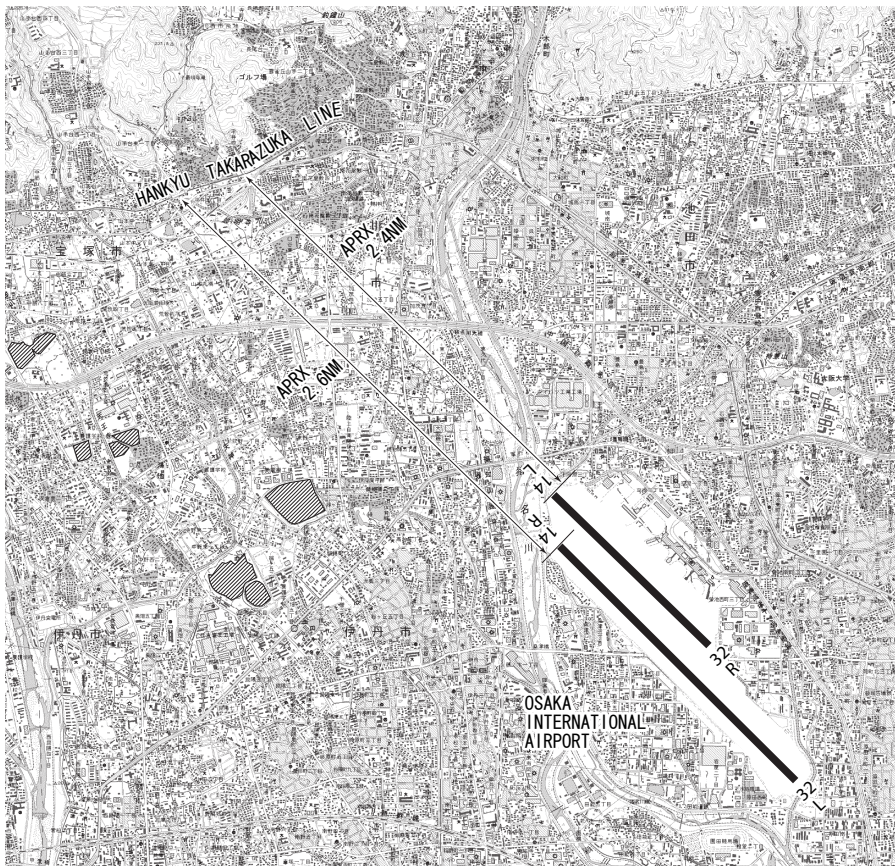

SCALE

1000 0 1000 3000 ft  
500 0 500 1000 m

大阪特別管制区  
Osaka Positive Control Area

OSAKA CTR

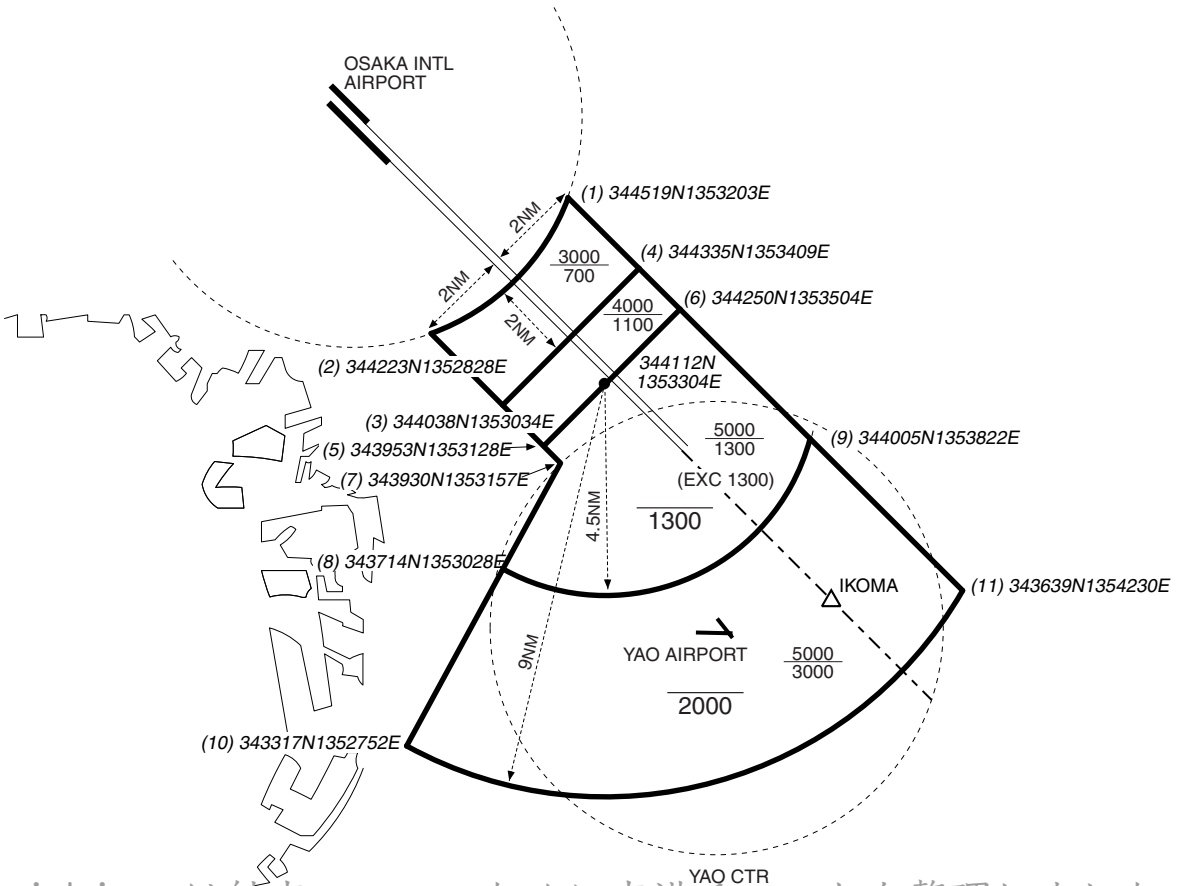

# ILS for RWY 32L

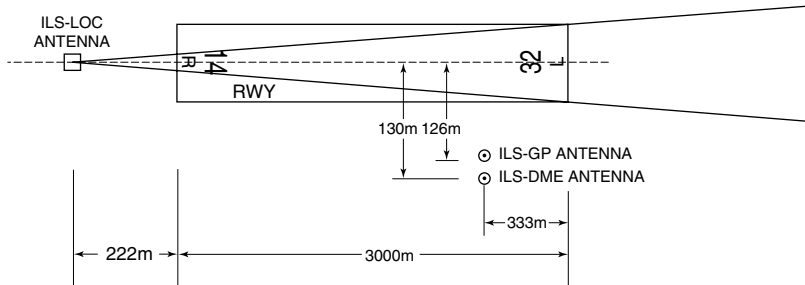

REMARKS : 1. ILS-LOC beam BRG(MAG)	322°
2. HGT of ILS REF datum	16.5m (54 ft)
3. ILS-GP Angle	3.0°
4. ELEV of ILS-DME	14.6m (48ft)



# Guide line and Guidance sign of TWY C1 & W10

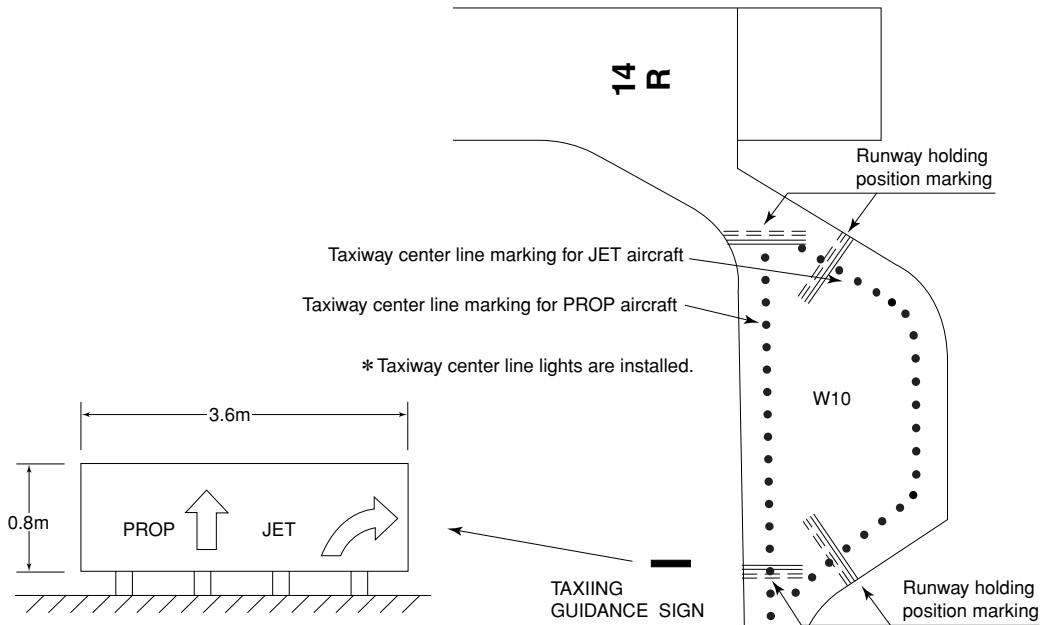
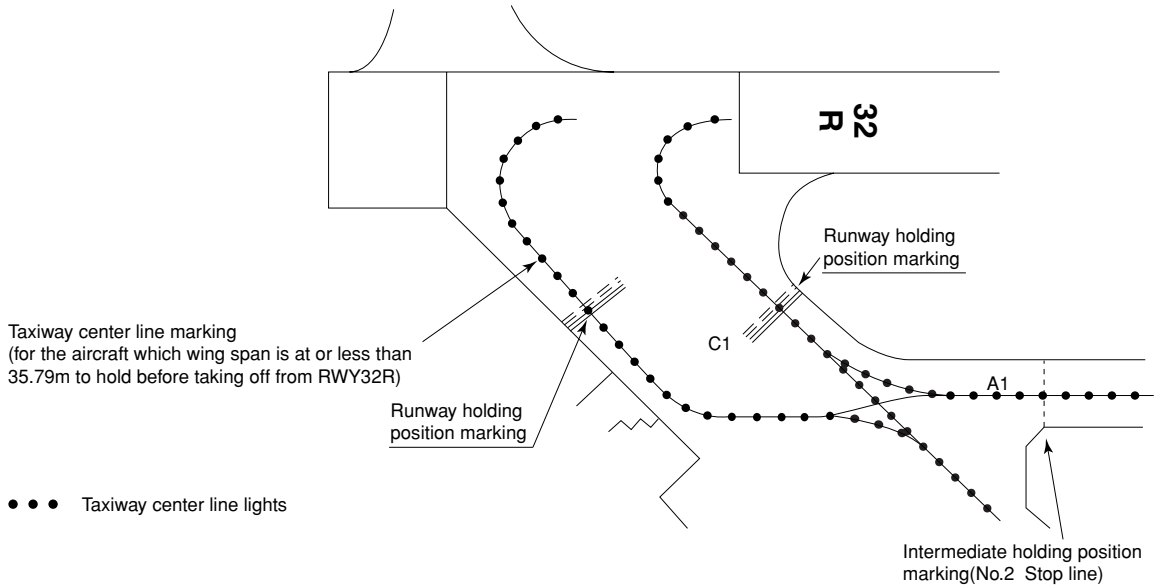

# Intermediate holding position marking (No.2 Stop line) on Taxiway A

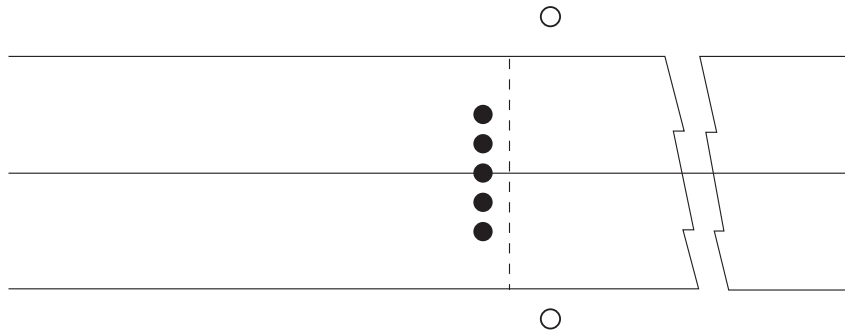

No.2

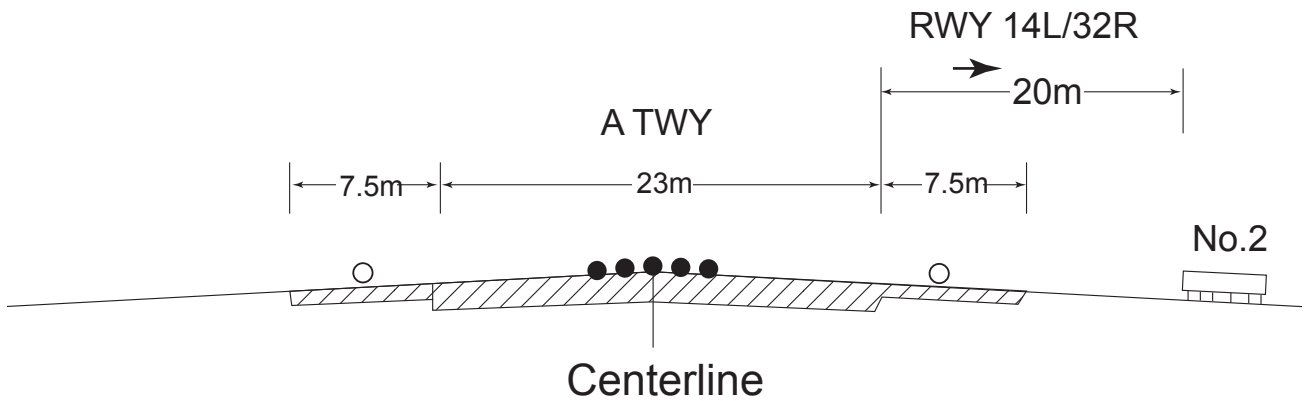

- Legend:
- Intermediate holding position light
  - Taxiway edge light
  - ▭ No.2 Taxiing guidance sign
  - Intermediate holding position marking

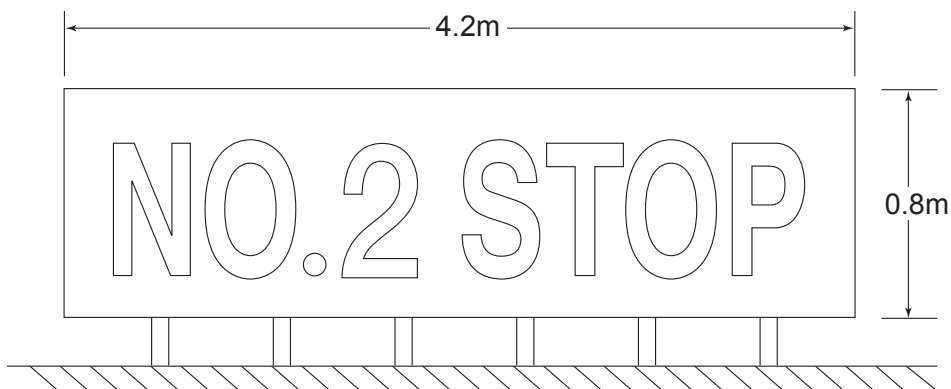

# Intermediate holding position marking (No.1 Stop line) on Taxiway B

No.1

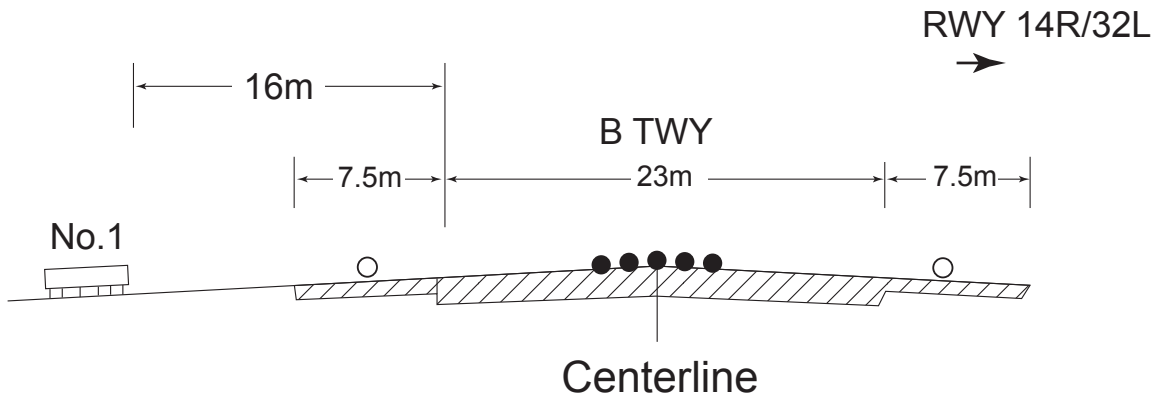
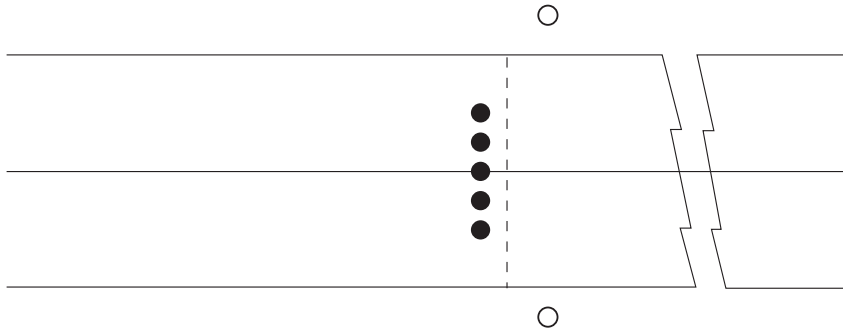

- Legend:
- Intermediate holding position light
  - Taxiway edge light
  - ▭ No.1 Taxiing guidance sign
  - Intermediate holding position marking



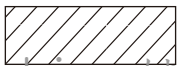
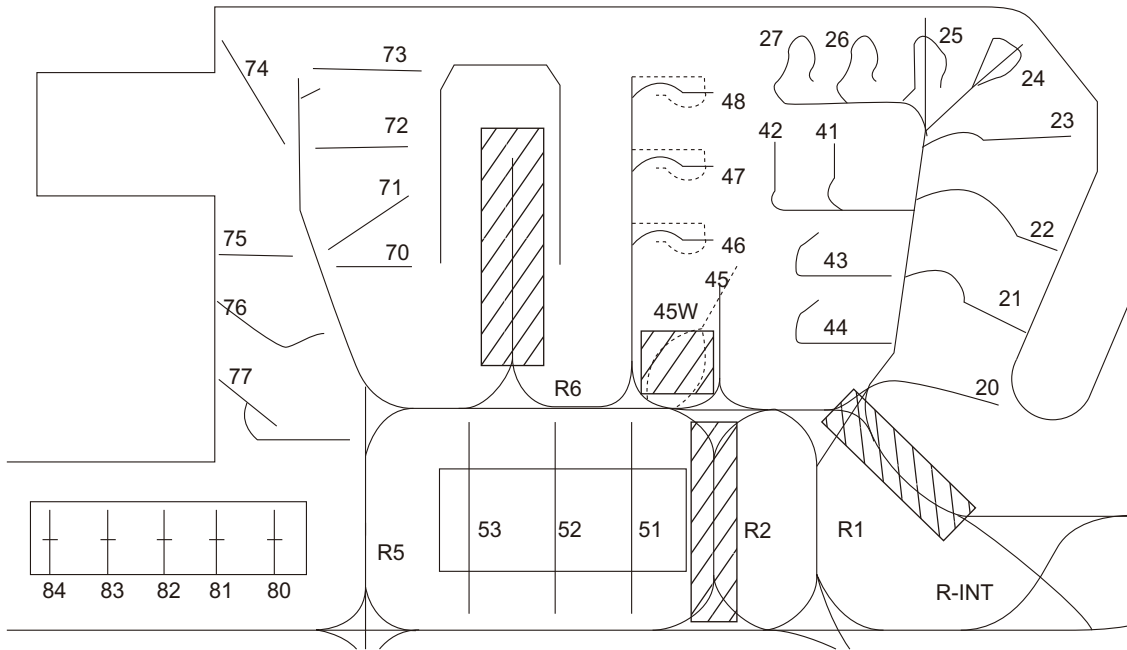

Restricted area

# A350-900における注意して走行すべき誘導路 TWY required to pay special attention for A350-900

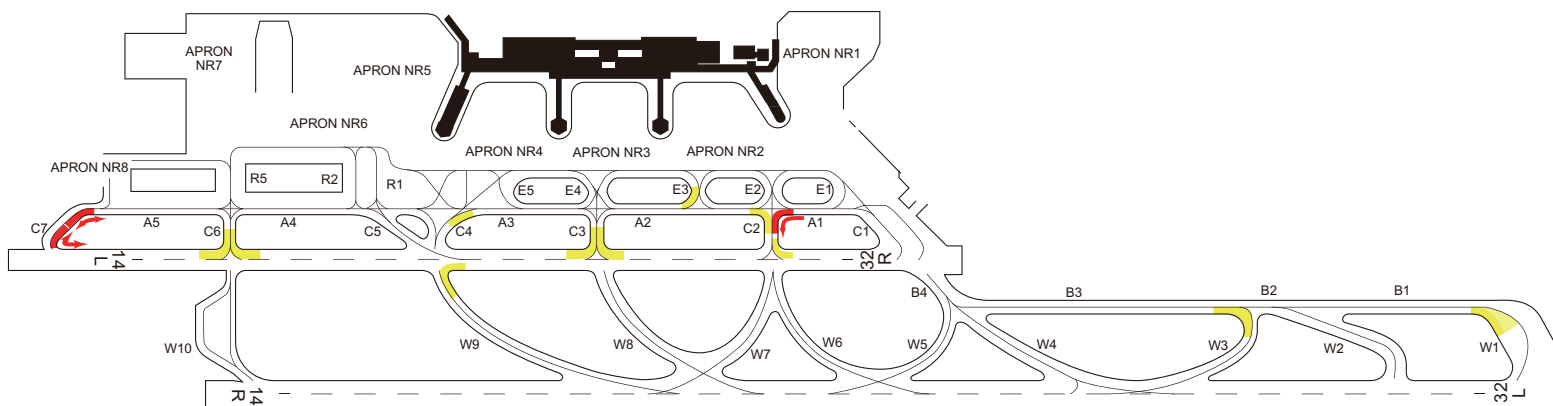

-  走行禁止経路  
Prohibited Course
-  Prohibited Turn Both Way
-  Prohibited Turn One Way  
(Opposite turn available with oversteering)
-  オーステアリング箇所  
Oversteering course

# B767-300における注意して走行すべき誘導路 TWY required to pay special attention for B767-300

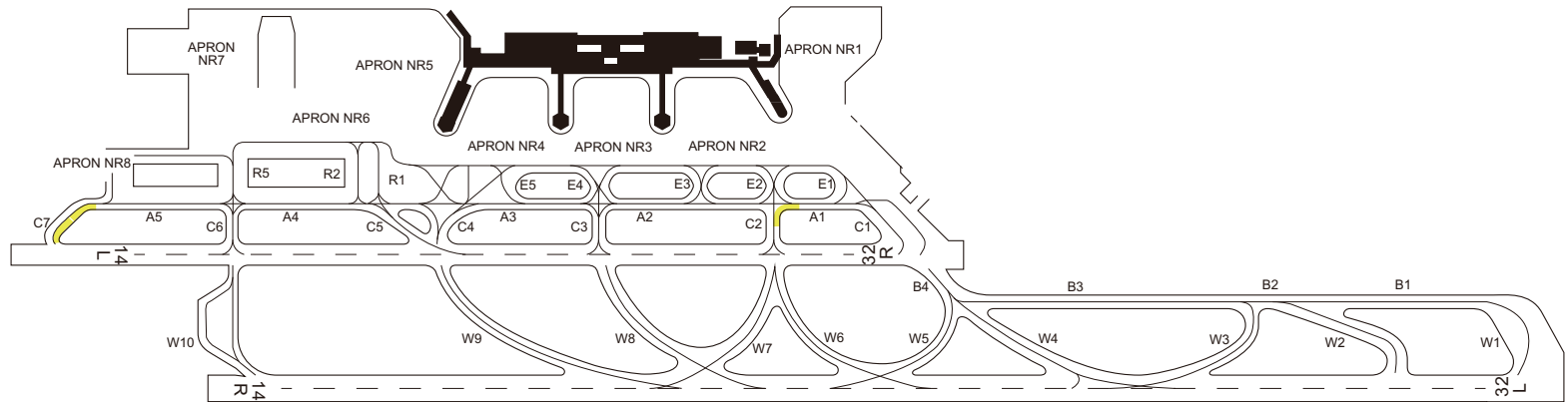

-  走行禁止経路  
Prohibited Course
-  Prohibited Turn Both Way
-  Prohibited Turn One Way  
(Opposite turn available with oversteering)
-  オーバーステアリング箇所  
Oversteering course

# B777-200における注意して走行すべき誘導路

## TWY required to pay special attention for B777-200

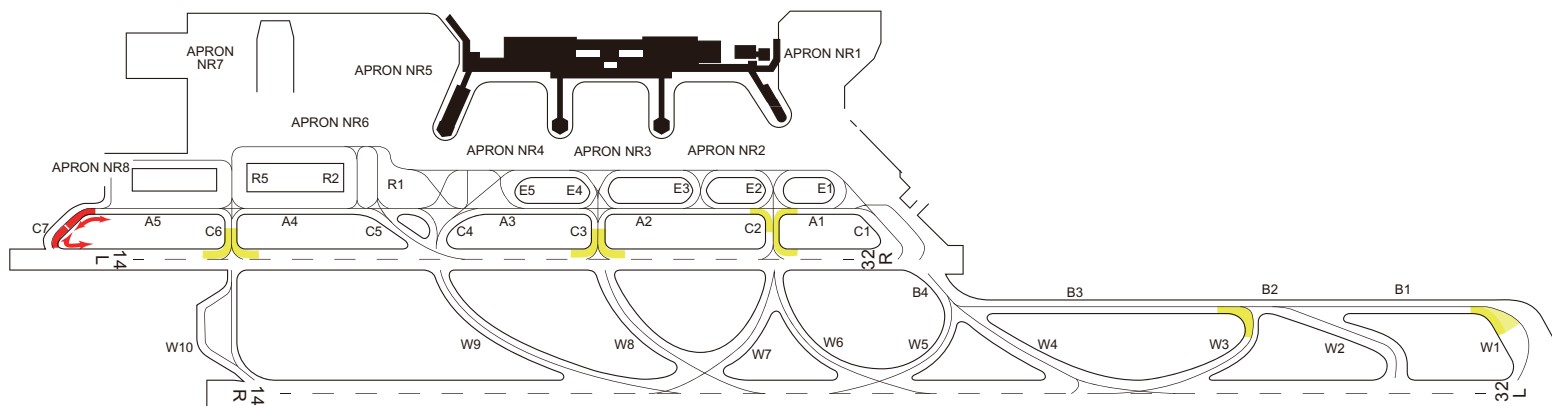

-  走行禁止経路  
Prohibited Course
-  Prohibited Turn Both Way
-  Prohibited Turn One Way  
(Opposite turn available with oversteering)
-  オーバーステアリング箇所  
Oversteering course

# B777-300における注意して走行すべき誘導路

## TWY required to pay special attention for B777-300

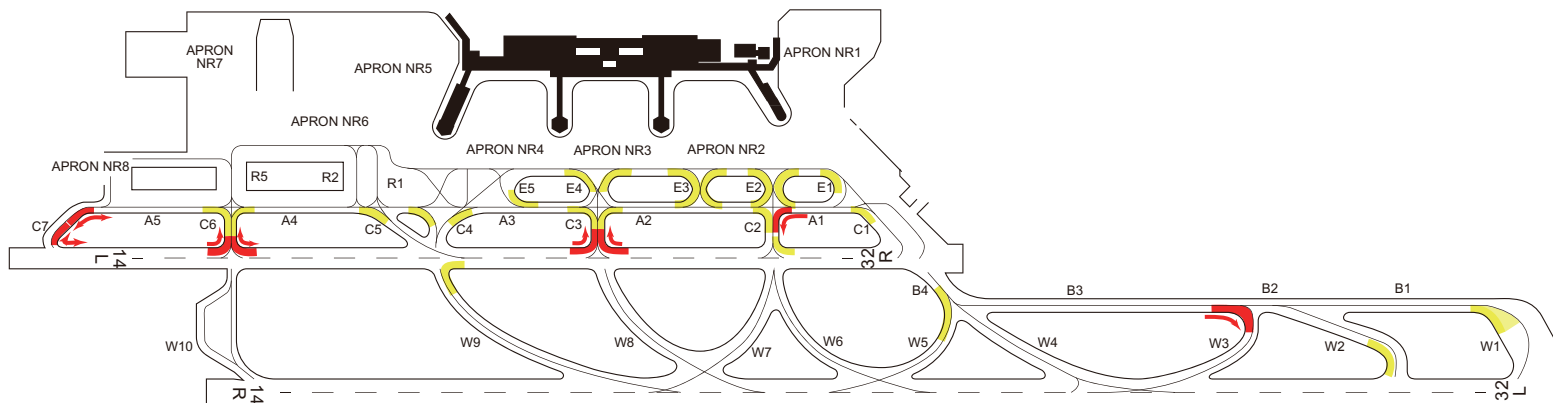

	走行禁止経路
	Prohibited Course
	Prohibited Turn Both Way
	Prohibited Turn One Way (Opposite turn available with oversteering)
	オーバーステアリング箇所
	Oversteering course



# B787-8における注意して走行すべき誘導路 TWY required to pay special attention for B787-8

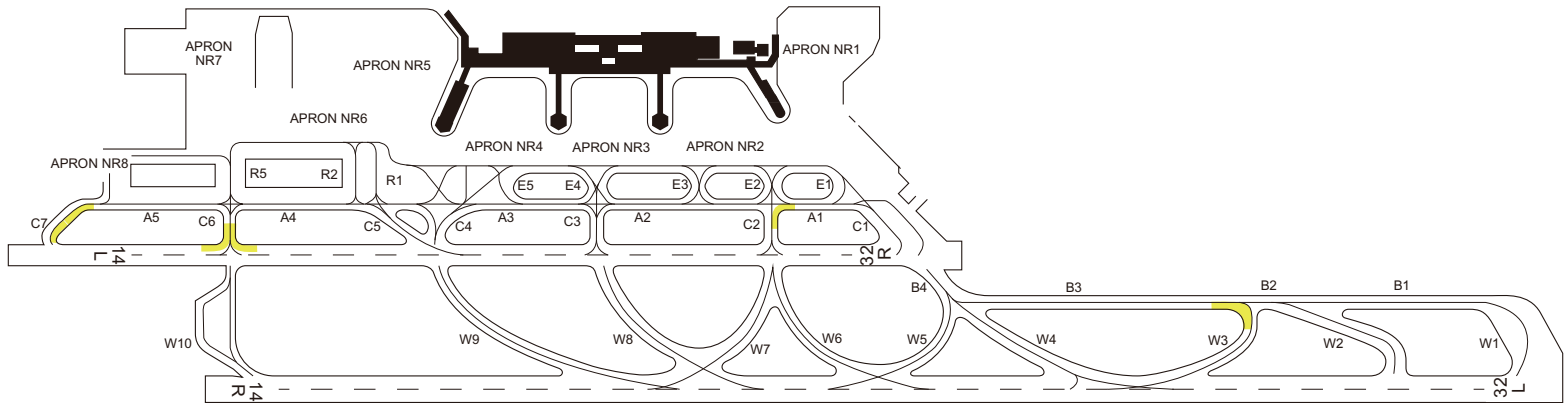

-  走行禁止経路  
Prohibited Course
-  Prohibited Turn Both Way
-  Prohibited Turn One Way  
(Opposite turn available with oversteering)
-  オバーステアリング箇所  
Oversteering course

B787-9における注意して走行すべき誘導路  
 TWY required to pay special attention for B787-9

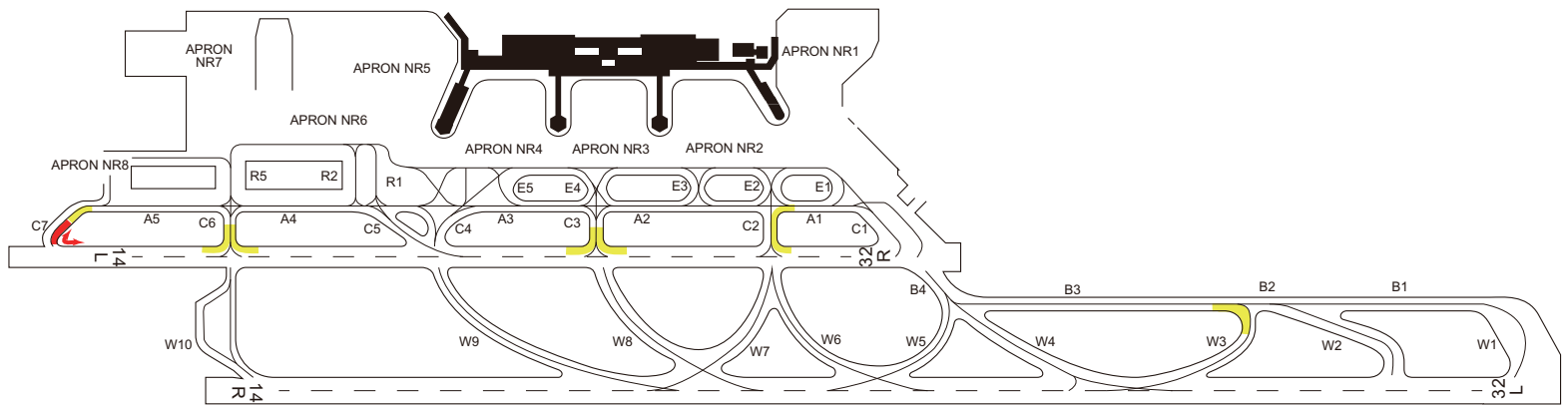

- 走行禁止経路  
Prohibited Course
- Prohibited Turn Both Way
- Prohibited Turn One Way  
(Opposite turn available with oversteering)
- オーバーステアリング箇所  
Oversteering course

# TAXIING HOLDING POSITION ON TWY W2

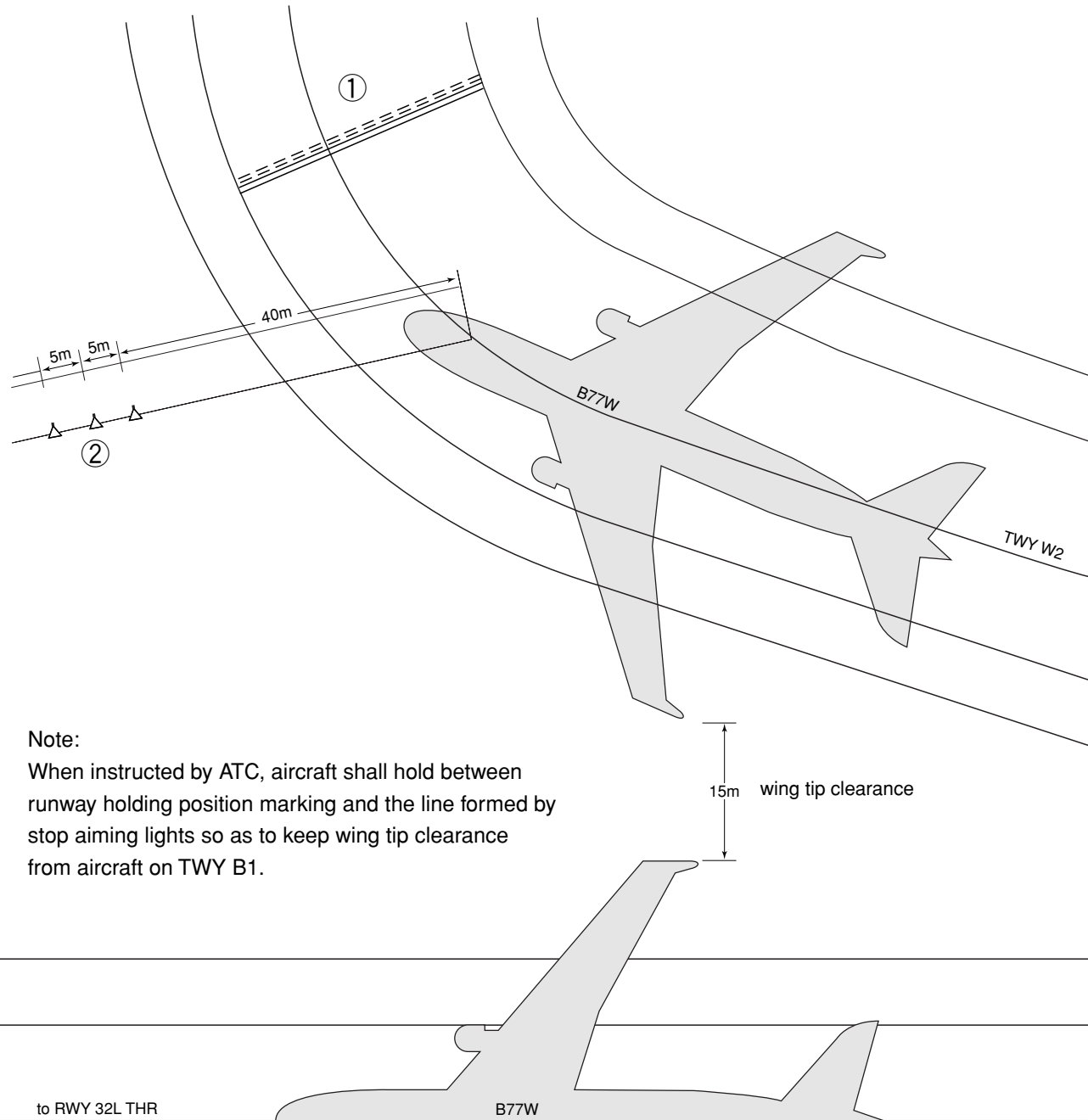

Note:  
When instructed by ATC, aircraft shall hold between runway holding position marking and the line formed by stop aiming lights so as to keep wing tip clearance from aircraft on TWY B1.

Legend: ① ≡≡≡ Runway holding position marking

② △△△ Stop aiming lights (Type : M-1 Red light)

# Taxiing and Taking off Procedure for RWY 32L

Key to the chart below:

- ① Runway holding position marking on TWY W2
- ② 2700m position from RWY 14R THR
- ③ NO.1 Stop line
- ④ PAPI
- ⑤ TKOF power setting position

\*See the back page for more detailed information.

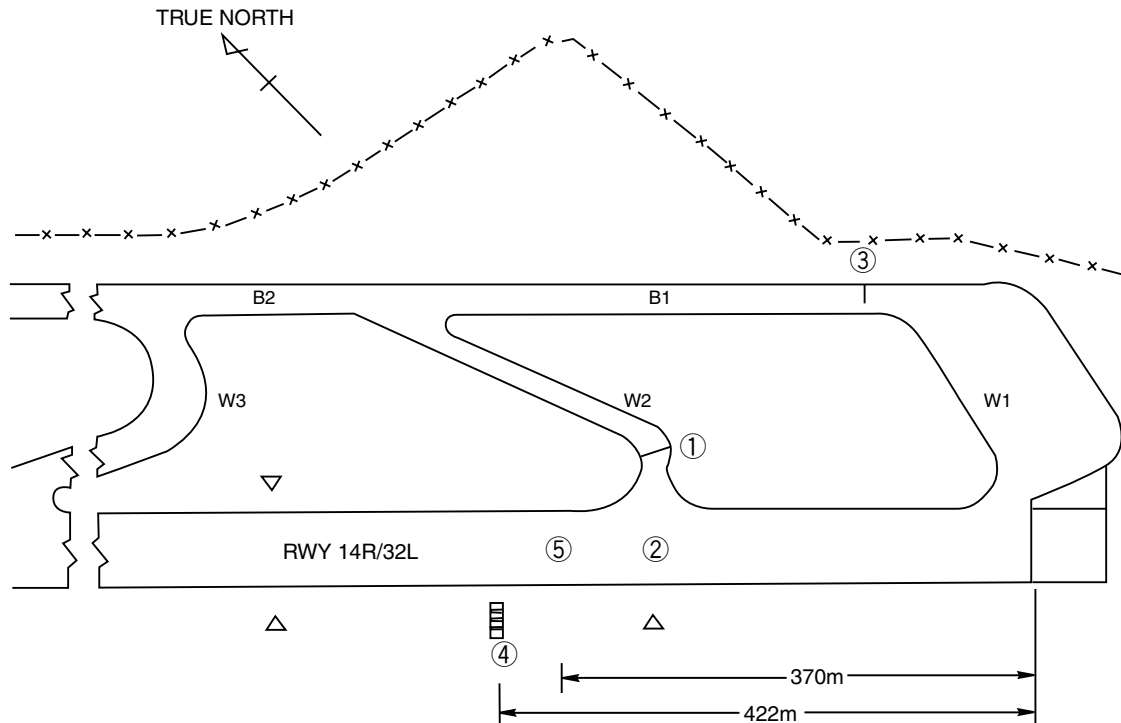

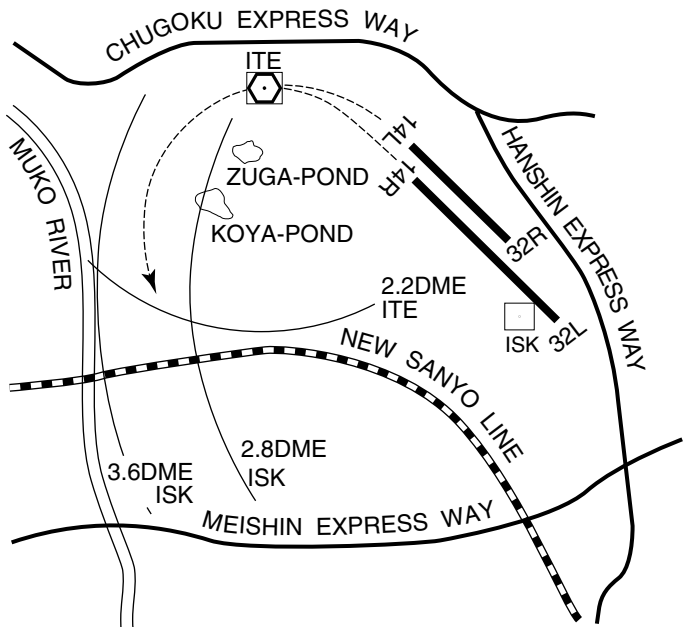

## Avoidance Flight of Mountainous Areas at OSAKA INTL Airport

For the purpose of avoiding collision at the mountainous area shown on the chart, the aircraft taking off from RWY 32 at OSAKA International Airport should turn to the left as soon as possible with due regard to the noise at the time of climbing, but without sacrificing the flight safety.

Note: The areas of hatching are obstructions which are projecting above the plane surface having a 40:1 slope from RWY 14 threshold.

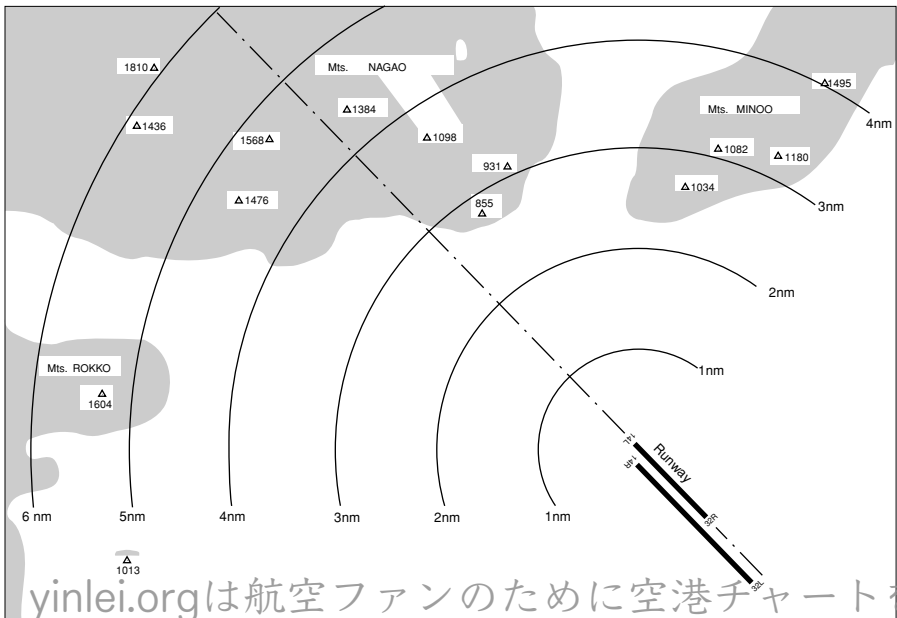

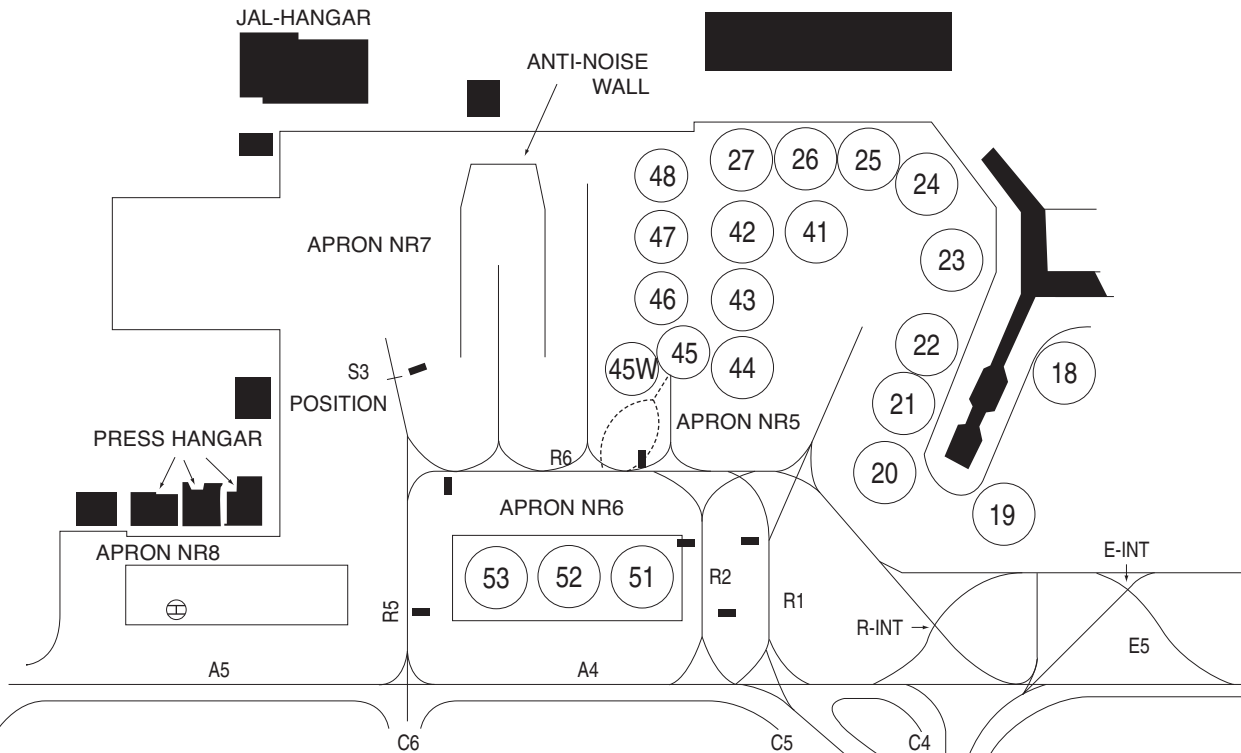

# AIRCRAFT STAND TAXILANE AND PARKING AREAS

R1, R2, R5, R6, apron TWY at Apron NR5, NR6, and NR7 :Aircraft stand taxilane  
 Spots 45, 45W, 46, 47, 48, 51 to 53 and Apron NR7 and NR8 :Parking areas  
 R-INT. and E-INT. :Intersections



# Runway Entrance Lights(REL) and Takeoff Hold Lights(THL)

-  Runway Entrance Lights (REL)
-  Takeoff Hold Lights (THL)
-  RWY HLDG PSN marking

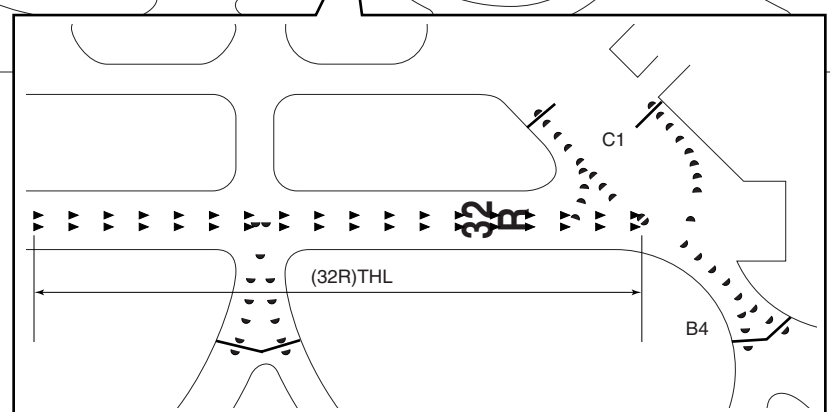
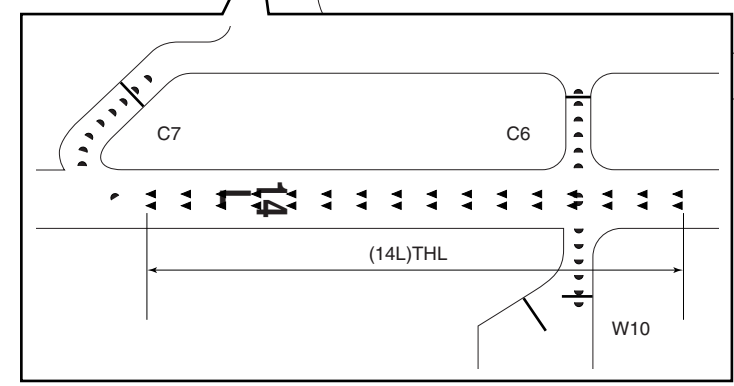
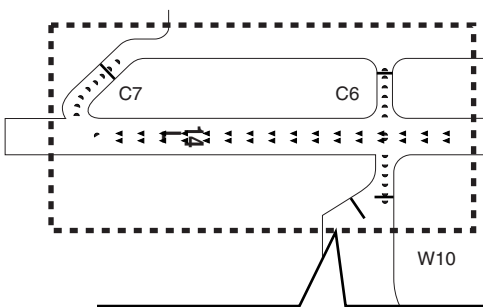
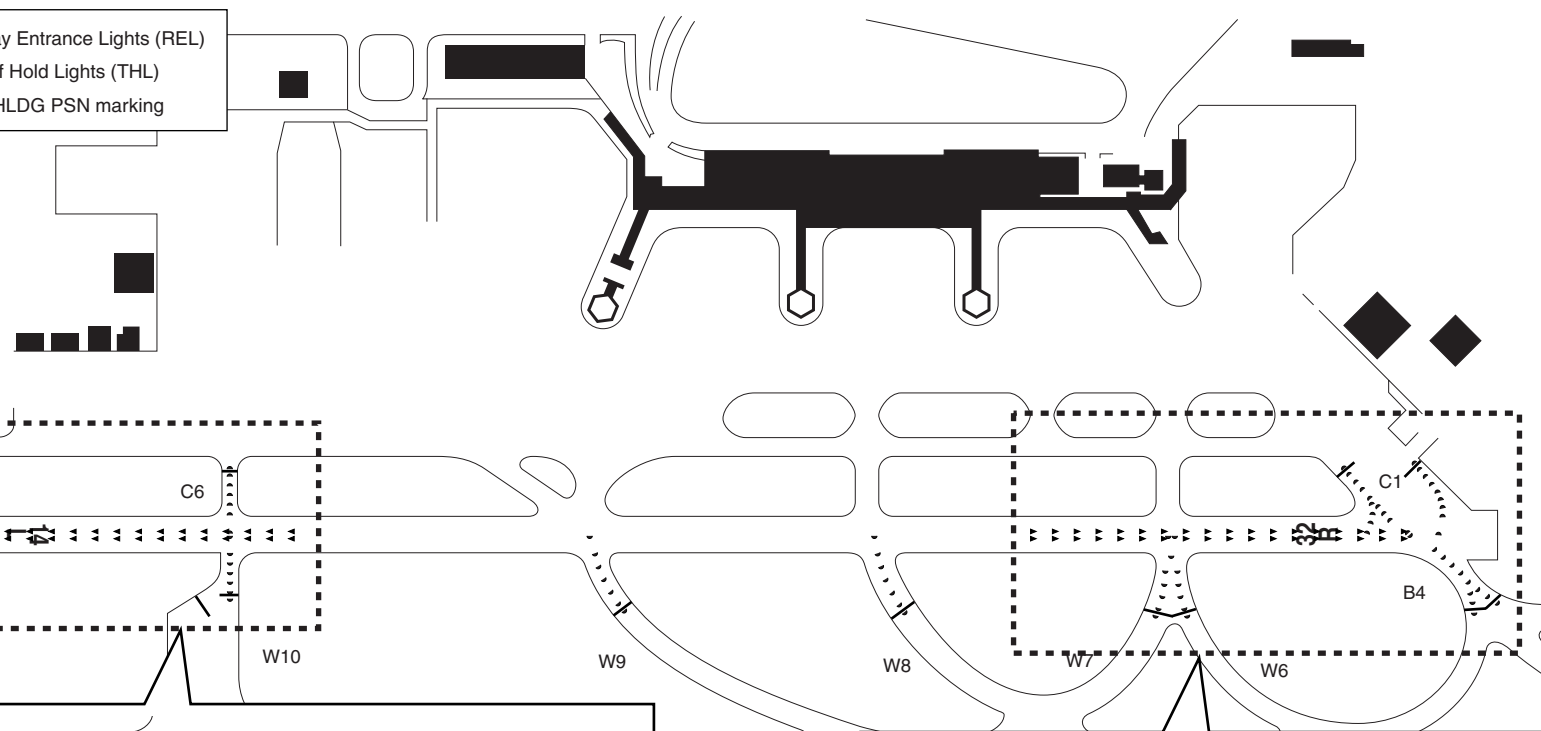

NOTE: The TWY names and RWY HLDG PSN markings in this ATTACHMENT are depicted only for the TWYs where REL are installed.



# Surface Painted Direction Sign and Surface Painted Location Sign

## Type of Surface Painted Markings

### 1.Type of Surface Painted Markings

#### Surface Painted Direction Sign

This type of marking at a taxiway intersection indicates the designation and direction of taxiway leading out of intersection.

Black inscriptions with an arrow with a yellow background.

2.On each of the Taxiway A3, A4, C4, behind APRON NR4, beside SPOT20, R1,R6,W9 and APRON Taxiway between SPOT43 and SPOT44 surface painted markings are provided (refer attached drawing).

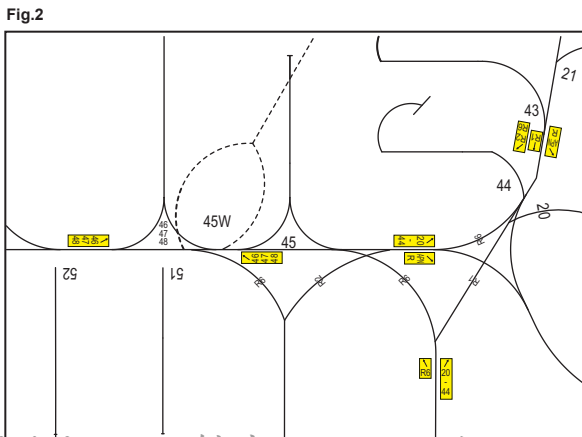
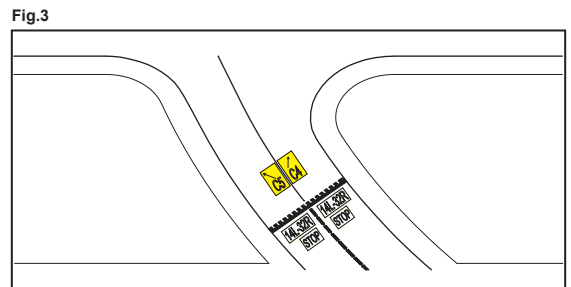
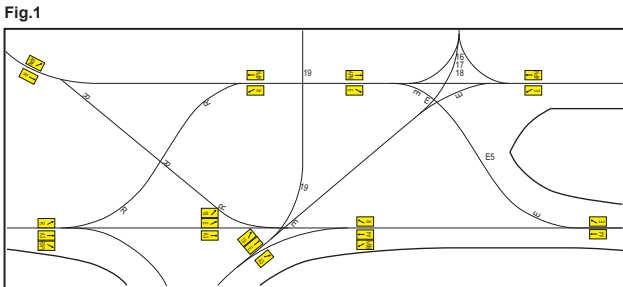
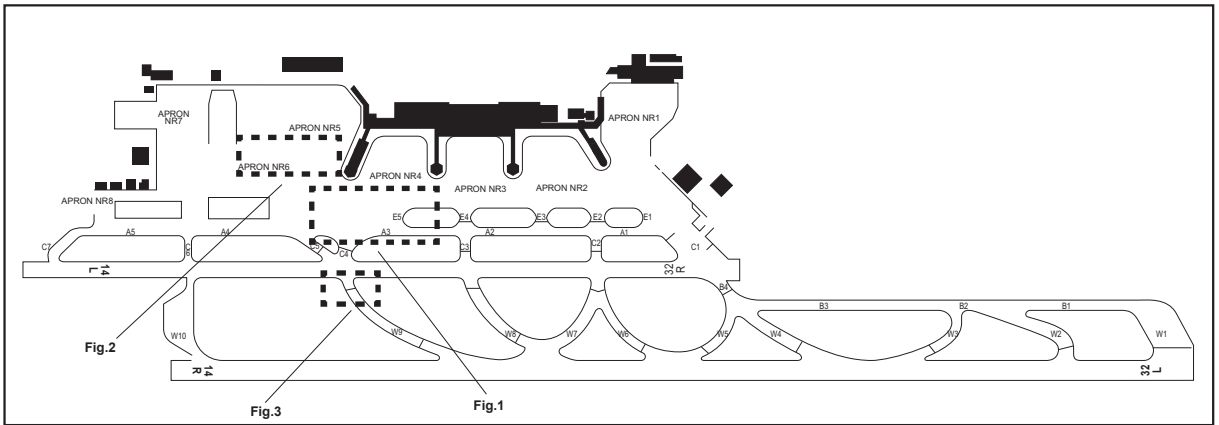

→ Fig.1 → Fig.2 →

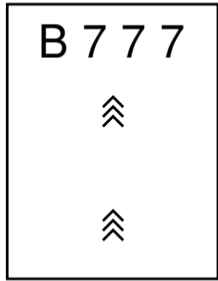

Fig.1

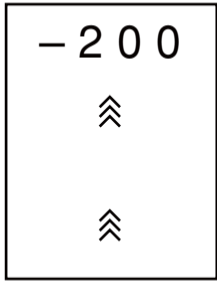

Fig.2

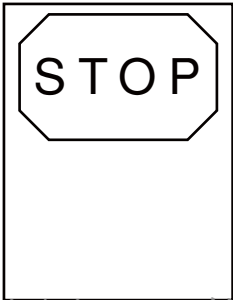

Fig.13

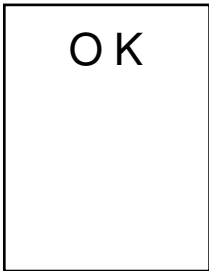

Fig.14

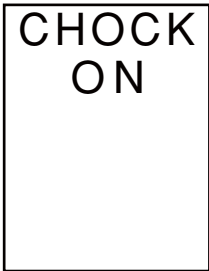

Fig.15

TOO  
FAR

Fig.16

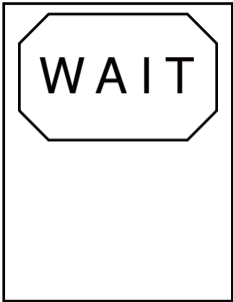

Fig. 17

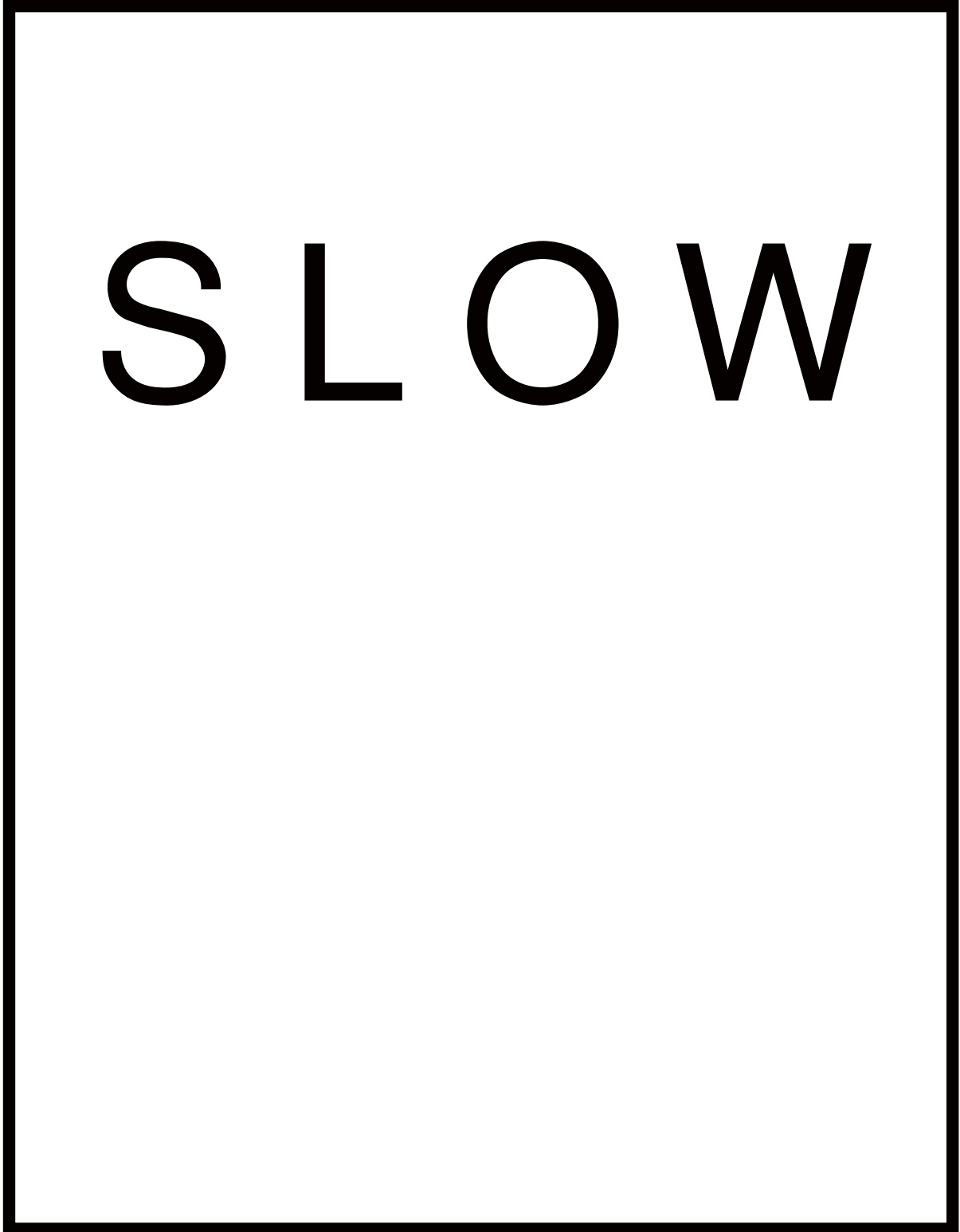

Fig.18

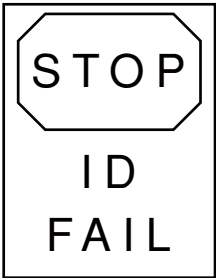

Fig.3



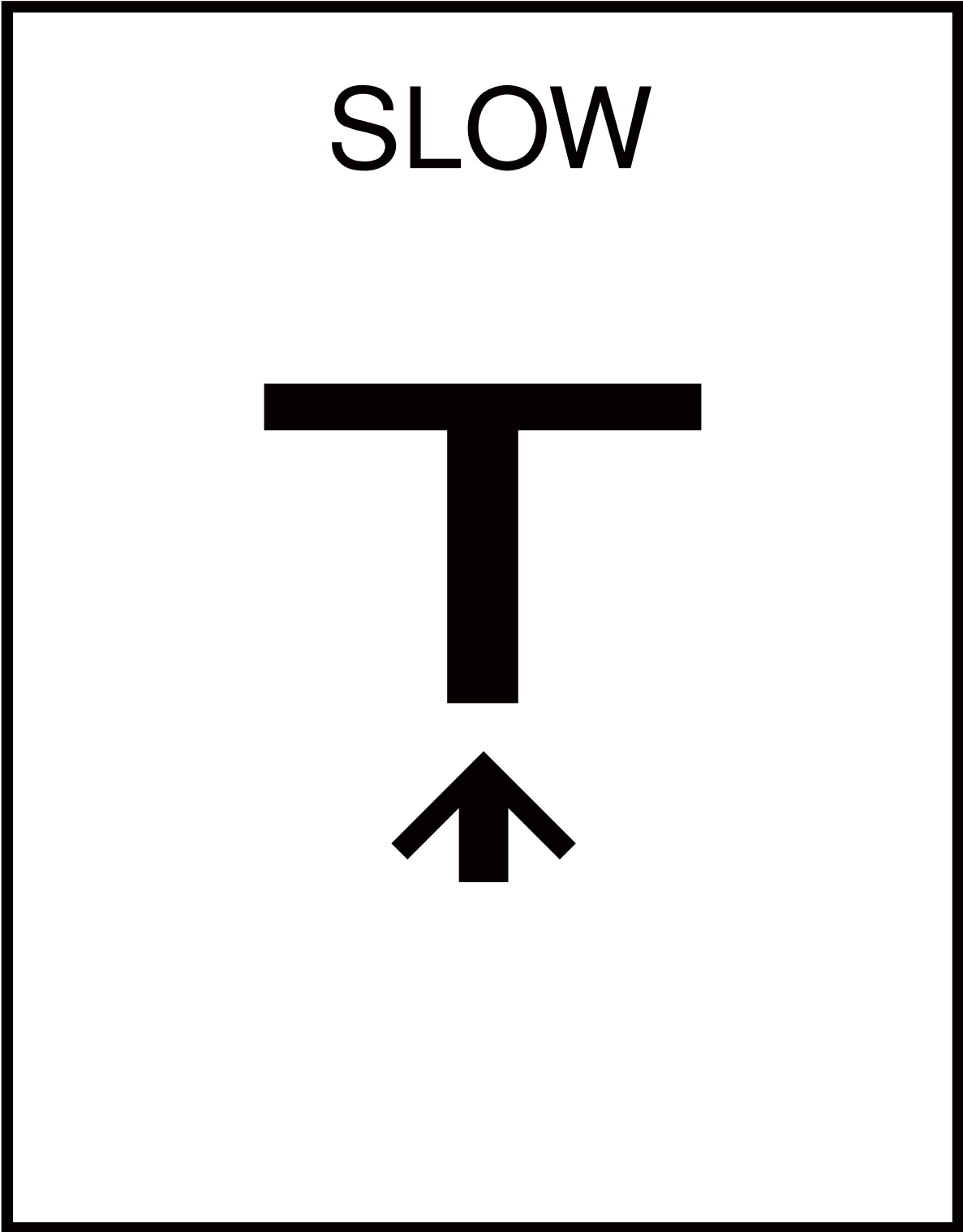

Fig.4

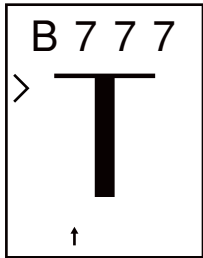

Fig.5

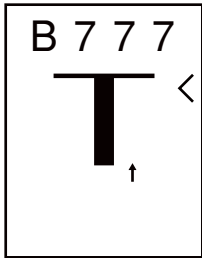

Fig.6

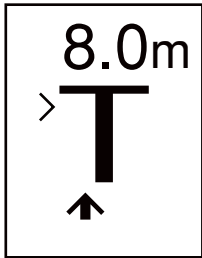

Fig.7

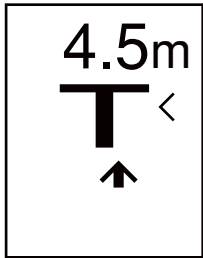

Fig.8

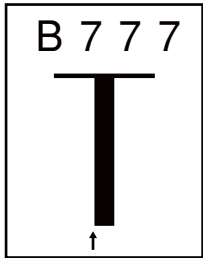

Fig.9

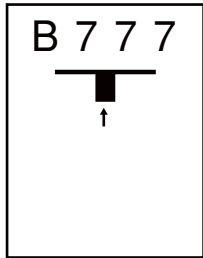

Fig.10

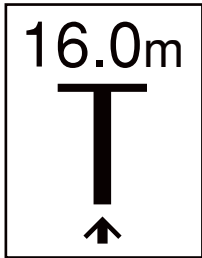

Fig.11

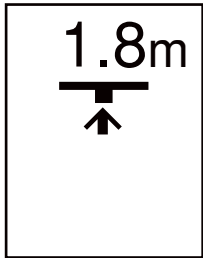

Fig.12