

AD 2 AERODROMES

RJFS AD 2.1 AERODROME LOCATION INDICATOR AND NAME

RJFS - SAGA

RJFS AD 2.2 AERODROME GEOGRAPHICAL AND ADMINISTRATIVE DATA

1	ARP coordinates and site at AD	330859N/1301808E 286° /1.0km FM RWY29 THR
2	Direction and distance from (city)	14.2km(7.6NM) S FM Saga JR station
3	Elevation/ Reference temperature	6.0ft/ 31.8°C(2002-2006)
4	Geoid undulation at AD ELEV PSN	106.34ft
5	MAG VAR/ Annual change	7°W(2006) / 1.5°W
6	AD Administration, address, telephone, telefax, telex, AFS, e-mail and/or Web-site addresses	Saga Pref. 9476-187, Inuido, Kawasoe-machi, Saga-city, Saga Pref. Tel: 0952-46-0150, Fax: 0952-46-0153
7	Types of traffic permitted(IFR/VFR)	IFR/VFR
8	Remarks	Saga Airport Branch(CAB). 9476-187, Inuido, Kawasoe-machi, Saga-city, Saga Pref., Japan Tel: 0952-46-0002, Fax: 0952-46-0004

RJFS AD 2.3 OPERATIONAL HOURS

1	AD Administration	2130 - 1500
2	Customs and immigration	Customs: 2330-0815 Immigration: INTL SKED FLT hours only
3	Health and sanitation	INTL SKED FLT hours only
4	AIS Briefing Office	Nil
5	ATS Reporting Office(ARO)	Nil
6	MET Briefing Office	H24 (FUKUOKA)
7	ATS	2130 - 1500 Remarks:2130-2300 and 1030-1500, Airport Remote Mobile Communication Service provided by Fukuoka FSC.
8	Fuelling	2130 - 1300
9	Handling	2130 - 1300
10	Security	2130 - 1300
11	De-icing	Nil
12	Remarks	Nil

RJFS AD 2.4 HANDLING SERVICES AND FACILITIES

1	Cargo-handling facilities	All the modern institutions that deal with the weight thing to Boeing767 type.
2	Fuel/ oil types	Fuel grades: Jet A1
3	Fuelling facilities/ capacity	Fuel truck / Not limited
4	De-icing facilities	Nil
5	Hangar space for visiting aircraft	Nil
6	Repair facilities for visiting aircraft	Nil
7	Remarks	Nil

RJFS AD 2.5 PASSENGER FACILITIES

1	Hotels	At Saga city
2	Restaurants	At Airport
3	Transportation	Buses and Taxi
4	Medical facilities	First aid, Hospital in Saga city 12km
5	Bank and Post Office	Bank : At Saga City Post Office : 6km North from Airport
6	Tourist Office	At Saga city
7	Remarks	Nil

RJFS AD 2.6 RESCUE AND FIRE FIGHTING SERVICES

1	AD category for fire fighting	CAT 8
2	Rescue equipment	Chemical fire fighting truck × 3 Emergency medical equipments conveyance truck × 1
3	Capability for removal of disabled aircraft	Ask AD administration
4	Remarks	Nil

RJFS AD 2.7 SEASONAL AVAILABILITY-CLEARING

1	Types of clearing equipment	Nil
2	Clearance priorities	Nil
3	Remarks	Nil

RJFS AD 2.8 APRONS, TAXIWAYS AND CHECK LOCATIONS DATA

1	Apron surface and strength	West Apron Surface: Concrete, Strength: PCN 74/R/B/X/T East Apron Surface: Asphalt-Concrete, Strength: PCN 13/F/C/Y/T
2	Taxiway width, surface and strength Asphalt Concrete	TWY T1 Width: 30m, Surface: asphalt-concrete, Strength: PCN 55/F/B/X/T TWY T2 Width: 9m, Surface: asphalt-concrete, Strength: PCN 13/F/C/Y/T
3	ACL and elevation	Not Available
4	VOR checkpoints	Not Available
5	INS checkpoints	(Spot NR) 10 : 330910.32N 1301805.68E 11 : 330910.79N 1301807.45E 12 : 330910.55N 1301809.07E 21 : 330910.25N 1301811.22E 22 : 330909.87N 1301813.98E
6	Remarks	Nil

RJFS AD 2.9 SURFACE MOVEMENT GUIDANCE AND CONTROL SYSTEM AND MARKINGS

1	Use of aircraft stand ID signs, TWY guide lines and Visual docking/ parking guidance system of aircraft stands	ACFT stand ID signs: Spot 12, 21 TWY guide line: T1 Visual docking guidance system: Nil
2	RWY and TWY markings and LGT	RWY: RWY11/29 (Marking) RWY designation, RWY CL, RWY THR, RWY middle point, Aiming point, TDZ, RWY side stripe, RWY turn pad CL, RWY turn pad edge line (LGT) RCLL, REDL, RTHL, RTZL, WBAR, Turning point indicator LGT TWY: T1 (Marking) Intermediate HLDG PSN (LGT) TWY edge LGT, TWY CL LGT, Taxiing guidance sign TWY: T2 (LGT) TWY edge LGT, Taxiing guidance sign
3	Stop bars	Nil
4	Remarks	(Marking) Overrun area, Aircraft parking position, Aircraft stand taxi lane. (LGT) Apron flood LGT

180° TURN ON RWYB767型機用の滑走路180°転回実施要項

1. 滑走路中心線からターニングパッド中心線標識に従って進行する。
2. 転回灯1が一直線に見えるように進行し、転回灯2が一直線に見えたとき転回を開始する。転回時はMAX STEERING ANGLEを使用する。

180°turn procedure on RWY for B767 aircraft

1. Proceed along the RWY Center Line to the starting point of the RWY Turn Pad Centerline Marking ; then
2. Proceed along RWY Turn Pad Center Line Marking to see the Turning Point Indicator Light 1 on a straight line, then commence turn at the spot where you (pilot) can see the Turning Point Indicator Lights 2 on a straight line at an angle of 9 o'clock. When turning, take MAX STEERING ANGLE.

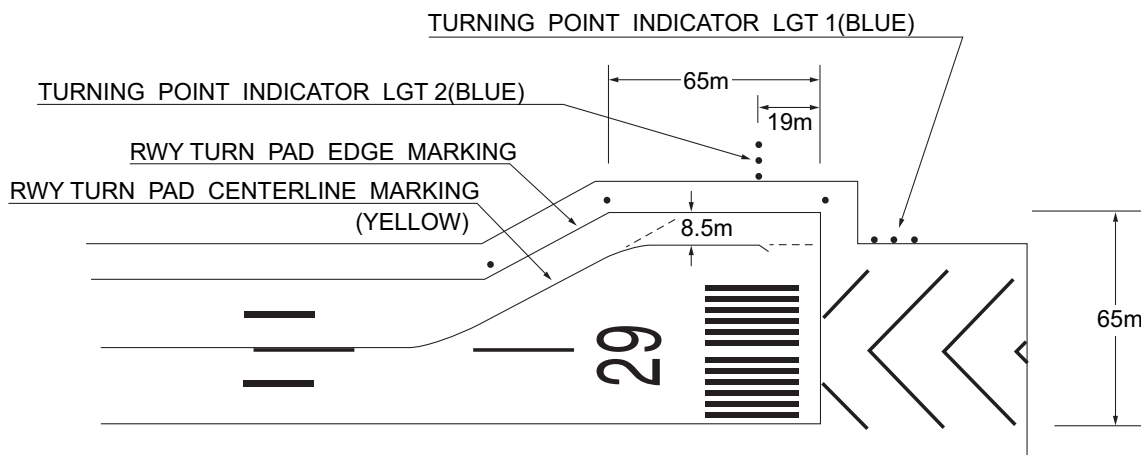
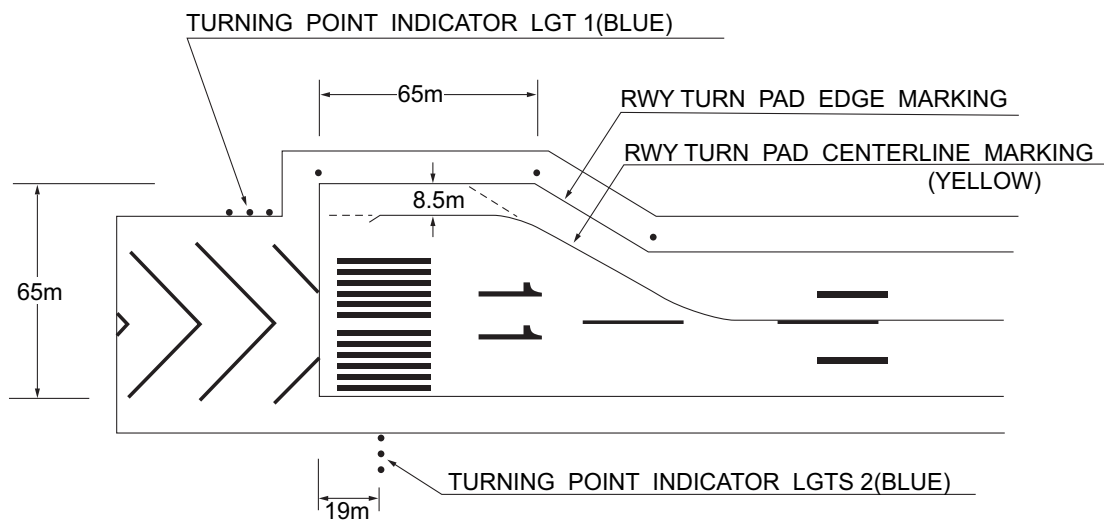
SAGA AP

RJFS AD 2.10 AERODROME OBSTACLES

In Area2 Nil

Other obstacles

OBST ID/designation	Obstacle type	Coordinates	Elevation	Markings/LGT	Remarks
RJFS1	Levee	330915.3N1301706.0E	25ft	- / LIL	Under APCH surface
RJFS2	Levee	330907.7N1301709.0E	25ft	- / LIL	Under APCH surface
RJFS3	Levee	330859.9N1301712.1E	25ft	- / LIL	Under APCH surface

In Area3 To be developed

RJFS AD 2.11 METEOROLOGICAL INFORMATION PROVIDED

1	Associated MET Office	FUKUOKA
2	Hours of service MET Office outside hours	H24 (FUKUOKA)
3	Office responsible for TAF preparation Periods of validity	FUKUOKA 30 Hours
4	Type of landing forecast interval of issuance	Nil
5	Briefing/ consultation provided	Briefing is available upon inquiry at FUKUOKA
6	Flight documentation Language(s) used	C En
7	Charts and other information available for briefing or consultation	S ₆ , U ₈₅ , U ₇ , U ₅ , U ₃ , U ₂₅ , U ₂ /T _r , P _S , P ₅ , P ₃ , P ₂₅ , P _{SWE} , P _{SWF} , P _{SWG} , P _{SWI} , P _{SWM} , P _{SW} (domestic), E, C, W _E , W _F , W _G , W _I , W, N
8	Supplementary equipment available for providing information	Nil
9	ATS units provided with information	RADIO / REMOTE
10	Additional information(limitation of service, etc.)	Nil

RJFS AD 2.12 RUNWAY PHYSICAL CHARACTERISTICS

Designations RWY NR	TRUE BRG	Dimensions of RWY(M)	Strength(PCN) and surface of RWY	THR coordinates THR geoid undulation	THR elevation and highest elevation of TDZ of precision APP RWY
1	2	3	4	5	6
11	099.25°	2000×45	PCN 68/F/C/X/T Asphalt-Concrete	330904.20N 1301729.91E	THR ELEV: 6ft
29	279.25°	2000×45	PCN 68/F/C/X/T Asphalt-Concrete	330853.77N 1301846.08E	THR ELEV: 6ft
Slope of RWY and SWY	Strip Dimensions(M)	RESA(Overrun) Dimensions(M)	Remarks		
7	10	11	14		
See below figure	2120 x 300	40x(MNM:247 MAX:300)*	RWY grooving: 2000m x 30m Turning pad installed		
See below figure	2120 x 300	193x(MNM:96 MAX:300)* *For detail, ask airport administrator	RWY grooving: 2000m x 30m Turning pad installed		

RWY 11 **RWY 29**

6ft 6ft 6ft 6ft

LEVEL 0.1% LEVEL

0m 1200m 1400m 2000m

RJFS AD 2.13 DECLARED DISTANCES

RWY Designator	TORA (m)	TODA (m)	ASDA (m)	LDA (m)	Remarks
1	2	3	4	5	6
11	2000	2000	2000	2000	Nil
29	2000	2000	2000	2000	Nil

RJFS AD 2.14 APPROACH AND RUNWAY LIGHTING

RWY Designator	APCH LGT type LEN INTST	RTHL Color WBAR	PAPI (VASIS) Angle DIST FM THR MEHT	RTZL LEN	RCLL LEN Spacing Color INTST	REDL LEN Spacing Color INTST	RENL Color WBAR	STWL LEN Color
1	2	3	4	5	6	7	8	9
11	SALS (*1) 420m LIH	Green Green	PAPI 3.0°/LEFT 366.2M 61ft	-	2,000m 30m Coded color (White/Red)	2,000m 60m Coded color (White/Yellow)	Red	Nil (*2)
29	PALS (CATI) 900m LIH	Green Green	PAPI 3.0°/LEFT 374.6M 61ft	900m	2,000m 30m Coded color (White/Red)	2,000m 60m Coded color (White/Yellow)	Red	Nil (*2)
Remarks								
10								
SALS with APCH LGT beacon(600m and 900m FM RWY 11 THR)(*1) Overrun area edge LGT(LEN:60m Color:Red)(*2) CGL for RWY 11 and RWY 29								

RJFS AD 2.15 OTHER LIGHTING, SECONDARY POWER SUPPLY

1	ABN/IBN location, characteristics and hours of operation	ABN: 330918N/1301806E, White/Green EV4.3sec, HO
2	LDI location and LGT Anemometer location and LGT	Nil RWY 11, RWY29/LGTD
3	TWY edge and center line lighting	TWY edge and center line lights installed, see AD2.9
4	Secondary power supply/ switch-over time	Within 1 sec : REDL, RTHL, WBAR, RCLL, Overrun area edge LGT, Turning point indicator LGT Within 15 sec : Other LGT
5	Remarks	WDI LGT

RJFS AD 2.16 HELICOPTER LANDING AREA

Nil

RJFS AD 2.17 ATS AIRSPACE

Designation and lateral limits		Vertical limits (ft)	Airspace classification	ATS unit call sign Language	Remarks
1		2	3	4	6
SAGA Information zone	Area within a radius of 5nm of SAGA ARP (3309N/13018E).	3000	E	SAGA RADIO, SAGA REMOTE(1) En	(1):2130-2300, 1030-1500

RJFS AD 2.18 ATS COMMUNICATION FACILITIES

Service designation	Call sign	Frequency	Hours of operation	Remarks
1	2	3	4	5
A/G	Saga Radio	118.025MHz(1) 126.2MHz	2300 - 1030	APP service provided by Fukuoka RADAR (1)Primary
A/G	Saga Remote	118.025MHz	2130 - 2300 1030 - 1500	RAG controlled by Fukuoka FSC APP service provided by 1) Kobe ACC : 2130 - 2145 and 1315 - 1500 2) Fukuoka RADAR : 2145 - 2300 and 1030 - 1315

RJFS AD 2.19 RADIO NAVIGATION AND LANDING AIDS

Type of aid (VOR declination)	ID	Frequency	Hours of operation	Site of transmitting antenna coordinates	Elevation DME transmitting antenna	Remarks
1	2	3	4	5	6	7
VOR (7°W/2013)	SGE	114.75MHz	H24	330855.03N 1301734.43E		
DME	SGE	1055MHz (CH-94Y)	H24	330855.03N 1301734.43E	40ft	
ILS-LOC 29 (CAT-I)	ISG	110.15MHz	2130 - 1500	330905.42N 1301721.02E		BRG(MAG)286° 233m(764ft) away FM RWY11 THR
ILS-GP 29		334.25MHz	2130 - 1500	330851.56N 1301833.39E		GP angle 3.0° HGT of ILS Ref datum 16.5m(54ft). 315m(1034ft) inside FM RWY29 THR 120m(394ft) S of RCL
ILS-DME 29	ISG	1125MHz	2130 - 1500	330851.33N 1301832.99E	22ft	323m(1060ft) inside FM RWY29 THR 129m(423ft) S of RCL
MSAS		1575.42MHz	H24			Transmitting antennas are satellite based.

ILS

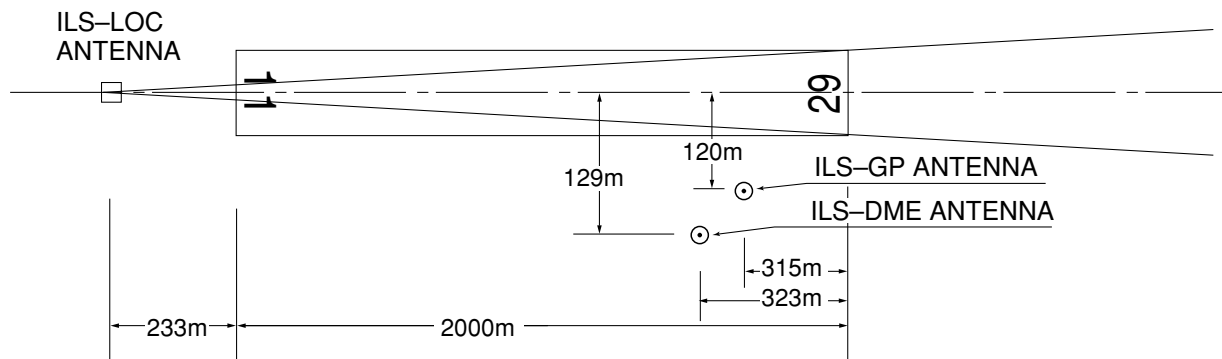

- REMARKS : 1. LOC beam BRG(MAG) 286°
 2. HGT of ILS REF datum 16.5m(54ft)
 3. GP Angle 3.0°
 4. ELEV of ILS-DME 6.6m(22ft)

RJFS AD 2.20 LOCAL TRAFFIC REGULATIONS

1. Airport regulations

Nil

2. Taxiing to and from stands

Nil

3. Parking area for small aircraft(General aviation)

Nil

4. Parking area for helicopters

Nil

5. Apron - taxiing during winter conditions

Nil

6. Taxiing - limitations

コード C 以上（翼端が 30m 以上）の航空機は原則としてターニングパッドを使用すること。	Aircraft with Wing span 30m or longer should use turning pads in principle.
--	---

7. School and training flights - technical test flights - use of runways

Nil

8. Helicopter traffic - limitation

Nil

9. Removal of disabled aircraft from runways

Nil

RJFS AD 2.21 NOISE ABATEMENT PROCEDURES

計器進入方式および標準計器出発方式の使用
(SEE AD1.1.6.5)

Use of Instrument Approach Procedure(IAP) & Standard Instrument Departure(SID) (SEE AD1.1.6.5)

すべての航空機を対象に、午後 10 時以降、午前 0 時までの間においては、空港周辺における航空機騒音軽減のため、緊急またはやむを得ない状況にある場合を除き、以下の計器進入方式及び標準計器出発方式によるものとする。

For all aircraft, between 2200JST(1300UTC) and 0000JST(1500UTC), in order to reduce aircraft noise in the vicinity of airport, except in emergency or unavoidable situation, pilots are requested to fly via the following SID and IAP.

(1) 到着 : VOR RWY11, RNAV(RNP) RWY11, RNAV(RNP) RWY29, VOR A, VOR C

(1) For arrivals : VOR RWY11, RNAV(RNP) RWY11, RNAV(RNP) RWY29, VOR A, VOR C

(2) 出発 : ARIAKE REVERSAL DEPARTURE, SOIGI DEPARTURE

(2) For departures : ARIAKE REVERSAL DEPARTURE, SOIGI DEPARTURE

注) 以下の方式は当該時間帯に限り使用される方式である。

Note) Following procedures should be used only between 2200JST(1300UTC) and 0000JST(1500UTC)

(1) 到着 : VOR RWY11

(1) For arrivals : VOR RWY11

(2) 出発 : ARIAKE REVERSAL DEPARTURE, SOIGI DEPARTURE

(2) For departures : ARIAKE REVERSAL DEPARTURE, SOIGI DEPARTURE

RJFS AD 2.22 FLIGHT PROCEDURES

TAKE OFF MINIMA

	RWY	ACFT CAT	REDL & RCLL		REDL or RCLL or RCL Marking		NIL (DAYTIME ONLY)	
			RVR	VIS	RVR	VIS	RVR	VIS
Multi-Engine ACFT with TKOF ALTN AP FILED	11	A,B,C,D	-	400m	-	400m	-	500m
	29	A,B,C,D	400m	400m	400m	400m	-	500m
OTHER	11	A,B,C,D	AVBL LDG MINIMA					
	29	A,B,C,D						

RJFS AD 2.23 ADDITIONAL INFORMATION

1. 空港を使用する場合は、あらかじめ佐賀空港事務所へ調整すること。

1. Prior notification should be required with AD Admsnistration when using the Airport.

RJFS AD 2.24 CHARTS RELATED TO AN AERODROME

- Aerodrome/Heliport Chart
- Standard Departure Chart - Instrument (SAGA, ARIAKE)
- Standard Departure Chart - Instrument (KIKYU)
- Standard Departure Chart - Instrument (BALLOON - RNAV)
- Standard Departure Chart - Instrument (SOIGI - RNAV)
- Standard Arrival Chart - Instrument (IRPIN NORTH, IRPIN SOUTH)
- Instrument Approach Chart (ILS or LOC RWY29)
- Instrument Approach Chart (VOR RWY29)
- Instrument Approach Chart (VOR RWY11)
- Instrument Approach Chart (RNAV(RNP) RWY29)
- Instrument Approach Chart (RNAV(RNP) RWY11)
- Instrument Approach Chart (VOR A)
- Instrument Approach Chart (VOR B)
- Instrument Approach Chart (VOR C)
- Other Chart (Visual REP)
- Other Chart (BALLOON)
- Other Chart (MVA CHART)

INTENTIONALLY LEFT BLANK

RJFS / SAGA

AD CHART

CHANGE : Spot NR renamed(11→10, 12→11, 13→12).

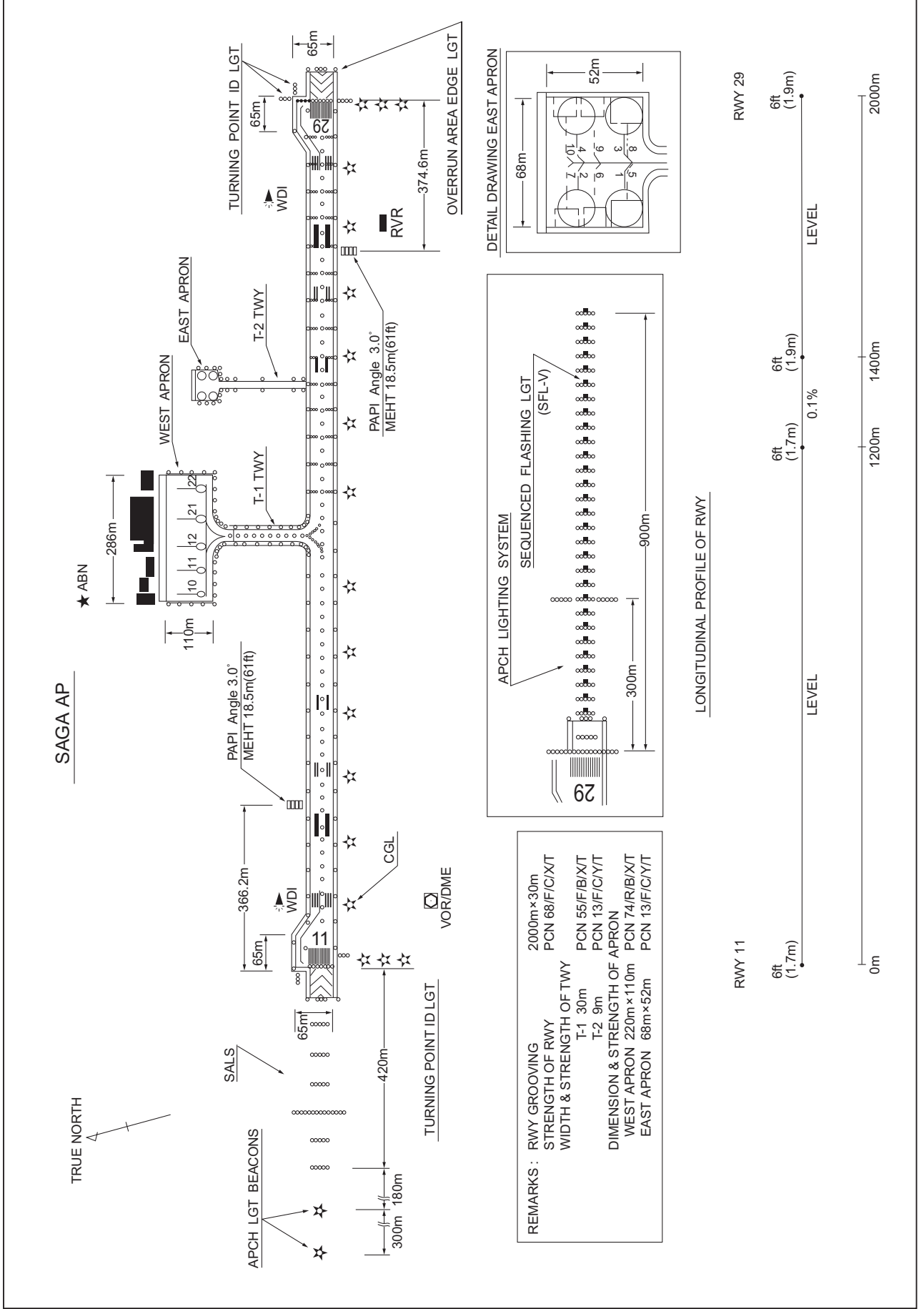

INTENTIONALLY LEFT BLANK

STANDARD DEPARTURE CHART - INSTRUMENT

RJFS / SAGA

RNAV SID

BALLOON ONE DEPARTURE

Basic RNP1

Note GNSS required.

VAR 7° W(2016)

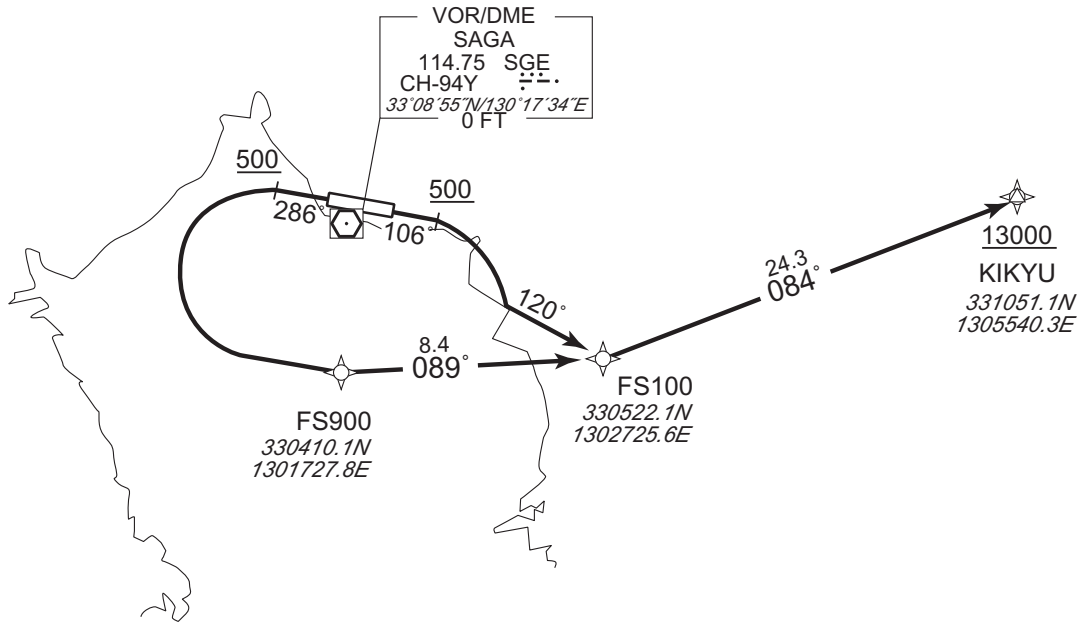

BALLOON ONE DEPARTURE

BALLOON ONE DEPARTURE

RWY11 : Climb on HDG106° at or above 500FT, turn right to FS100 on track 120°, to KIKYU at or above 13000FT.

RWY29 : Climb on HDG286° at or above 500FT, turn left direct to FS900, to FS100, to KIKYU at or above 13000FT.

NOTE RWY29 : 3.5% climb gradient required up to 500FT.

STANDARD DEPARTURE CHART - INSTRUMENT

RJFS / SAGA

RNAV SID

BALLOON ONE DEPARTURE

RWY11

Serial Number	Path Descriptor	Waypoint Identifier	Fly Over	Course °M(°T)	Magnetic Variation	Distance (NM)	Turn Direction	Altitude (FT)	Speed (KIAS)	Vertical Angle	Navigation Specification
001	VA	—	—	106 (099.3)	-7.2	—	—	+500	—	—	Basic RNP1
002	CF	FS100	—	120 (113.2)	-7.2	—	—	—	—	—	Basic RNP1
003	TF	KIKYU	—	084 (076.8)	-7.2	24.3	—	+13000	—	—	Basic RNP1

RWY29

Serial Number	Path Descriptor	Waypoint Identifier	Fly Over	Course °M(°T)	Magnetic Variation	Distance (NM)	Turn Direction	Altitude (FT)	Speed (KIAS)	Vertical Angle	Navigation Specification
001	VA	—	—	286 (279.3)	-7.2	—	—	+500	—	—	Basic RNP1
002	DF	FS900	—	—	-7.2	—	L	—	—	—	Basic RNP1
003	TF	FS100	—	089 (081.8)	-7.2	8.4	—	—	—	—	Basic RNP1
004	TF	KIKYU	—	084 (076.8)	-7.2	24.3	—	+13000	—	—	Basic RNP1

STANDARD DEPARTURE CHART - INSTRUMENT

RJFS / SAGA

RNAV SID

SOIGI ONE DEPARTURE

Basic RNP1

Note GNSS required.

VAR 7° W(2016)

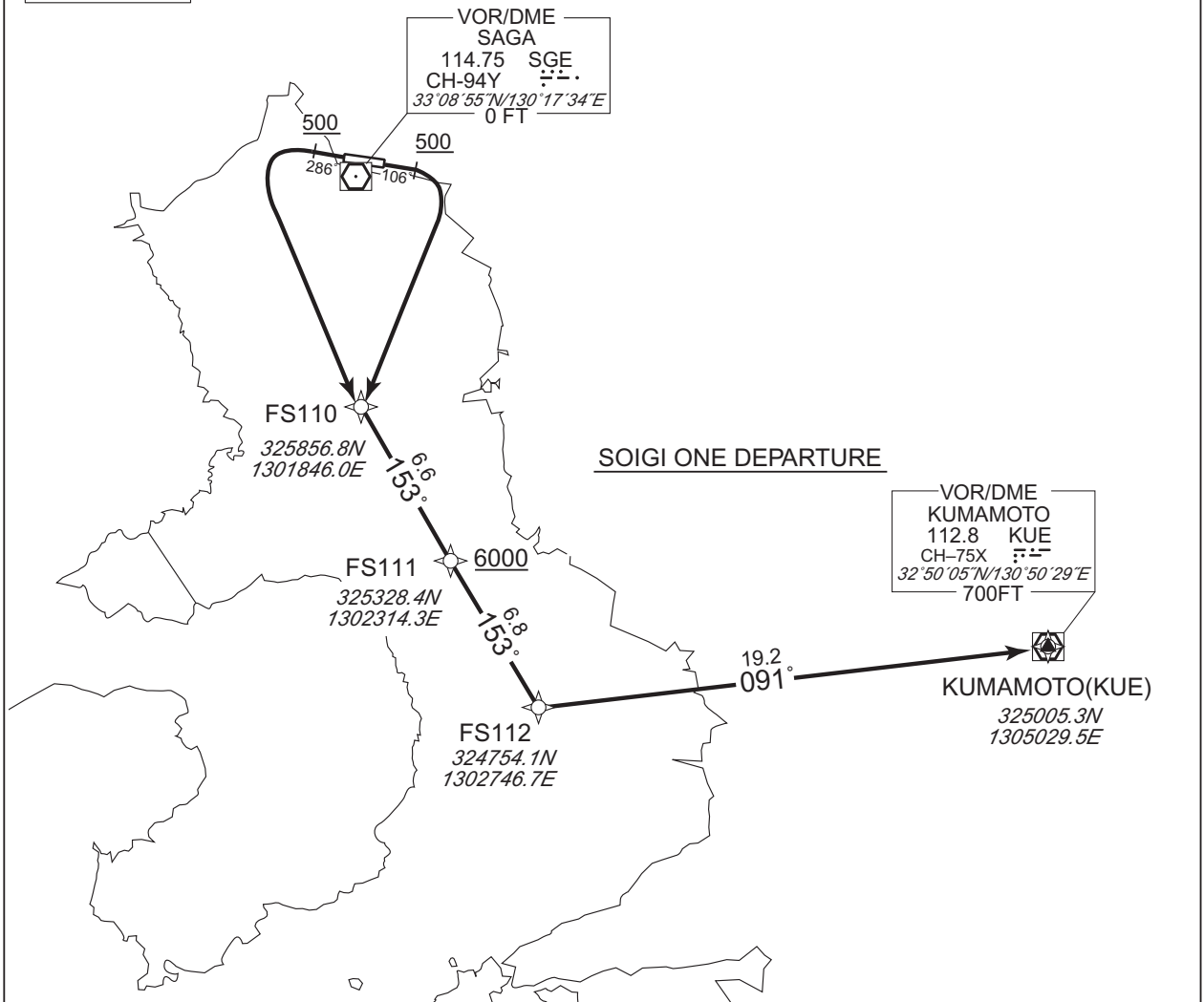

SOIGI ONE DEPARTURE

RWY11 : Climb on HDG106° at or above 500FT, turn right direct to FS110, to FS111 at or above 6000FT, to FS112, to KUE.

RWY29 : Climb on HDG286° at or above 500FT, turn left direct to FS110, to FS111 at or above 6000FT, to FS112, to KUE.

NOTE RWY29 : 3.5% climb gradient required up to 500FT.

STANDARD DEPARTURE CHART - INSTRUMENT

RJFS / SAGA

RNAV SID

SOIGI ONE DEPARTURE

RWY11

Serial Number	Path Descriptor	Waypoint Identifier	Fly Over	Course °M(°T)	Magnetic Variation	Distance (NM)	Turn Direction	Altitude (FT)	Speed (KIAS)	Vertical Angle	Navigation Specification
001	VA	—	—	106 (099.3)	-7.2	—	—	+500	—	—	Basic RNP1
002	DF	FS110	—	—	-7.2	—	R	—	—	—	Basic RNP1
003	TF	FS111	—	153 (145.5)	-7.2	6.6	—	+6000	—	—	Basic RNP1
004	TF	FS112	—	153 (145.6)	-7.2	6.8	—	—	—	—	Basic RNP1
005	TF	KUE	—	091 (083.4)	-7.2	19.2	—	—	—	—	Basic RNP1

RWY29

Serial Number	Path Descriptor	Waypoint Identifier	Fly Over	Course °M(°T)	Magnetic Variation	Distance (NM)	Turn Direction	Altitude (FT)	Speed (KIAS)	Vertical Angle	Navigation Specification
001	VA	—	—	286 (279.3)	-7.2	—	—	+500	—	—	Basic RNP1
002	DF	FS110	—	—	-7.2	—	L	—	—	—	Basic RNP1
003	TF	FS111	—	153 (145.5)	-7.2	6.6	—	+6000	—	—	Basic RNP1
004	TF	FS112	—	153 (145.6)	-7.2	6.8	—	—	—	—	Basic RNP1
005	TF	KUE	—	091 (083.4)	-7.2	19.2	—	—	—	—	Basic RNP1

INSTRUMENT APPROACH CHART

RJFS / SAGA

RNAV(RNP) RWY11

FUKUOKA RADAR 119.7 – 279.2	GNSS and RF required.	SAGA RADIO 118.025 – 126.2	(2130–2300(UTC) 1030–1500 SAGA REMOTE 118.025	NO RADAR
--------------------------------	-----------------------	-------------------------------	--	----------

For uncompensated Baro-VNAV systems, procedure not authorized below -10°C / above 45°C

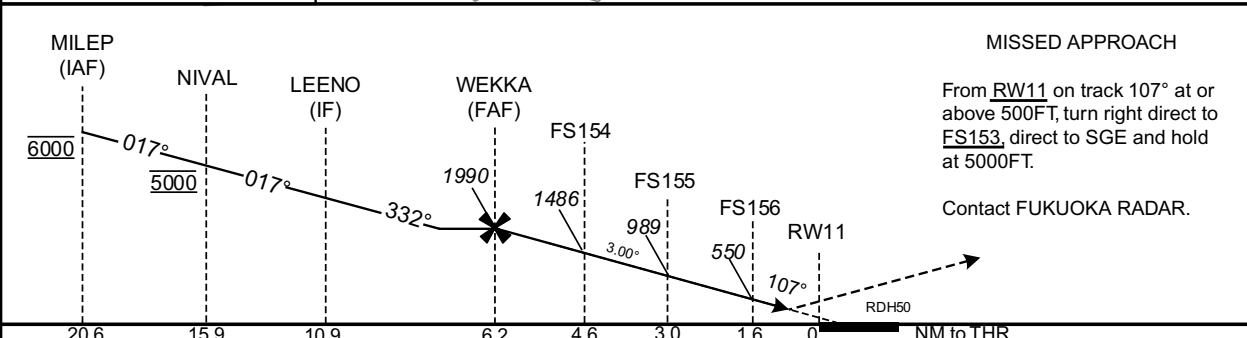
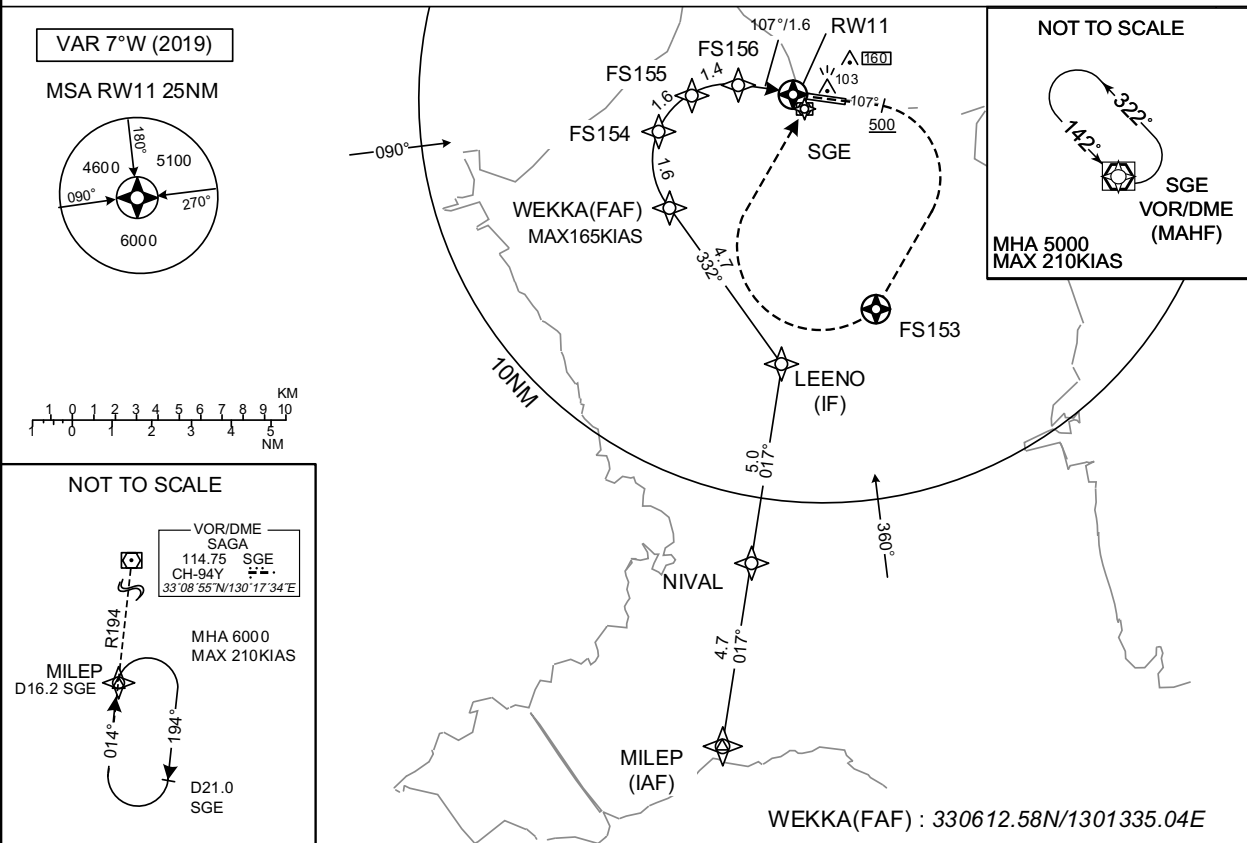

Missed APCH climb gradient MNM 3.0%

MINIMA	THR elev.6	AD elev.6
RNP 0.30		
CAT	DA(H)	CMV
A	-	-
B	-	-
C	306 (300)	1400
D		1600

RNP AR
Special Authorization Required

MINIMA with Missed APCH climb gradient of 2.5% are not established.

CHANGE : ATC callsign changed (FUKUOKA DEP→FUKUOKA RADAR). ATC FREQ changed.

INSTRUMENT APPROACH CHART

RJFS / SAGA

RNAV(RNP) RWY11

RNAV(RNP) RWY11

Coding Table

Serial Number	Path Descriptor	Waypoint Identifier	Fly Over	Course °M(°T)	Magnetic Variation	Distance (NM)	Turn Direction	Altitude (FT)	Speed (KIAS)	VPA/RDH (°/FT)	RNP Value
001	IF	MILEP	-	-	-7.5	-	-	6000	-	-	-
002	TF	NIVAL	-	017 (009.2)	-7.5	4.7	-	5000	-	-	0.3
003	TF	LEENO	-	017 (009.2)	-7.5	5.0	-	-	-	-	0.3
004	TF	WEKKA	-	332 (324.3)	-7.5	4.7	-	1990	-165	-	0.3
005	RF Center: FSRF5 r=2.02NM	FS154	-	-	-7.5	1.6	R	1486	-	-3.00	0.3
006	RF Center: FSRF6 r=1.98NM	FS155	-	-	-7.5	1.6	R	989	-	-3.00	0.3
007	RF Center: FSRF7 r=1.77NM	FS156	-	-	-7.5	1.4	R	550	-	-3.00	0.3
008	TF	RW11	Y	107 (099.3)	-7.5	1.6	-	56	-	-3.00/50	0.3
009	FA	-	-	107 (099.3)	-7.5	-	-	+500	-	-	1.0
010	DF	FS153	Y	-	-7.5	-	R	-	-	-	1.0
011	DF	SGE	-	-	-7.5	-	R	5000	-	-	1.0

Waypoint Coordinates

Waypoint Identifier	Coordinates	RF Arc Center Identifier	Coordinates
MILEP	325250.49N/1301501.22E	FSRF5	330723.51N/1301531.82E
NIVAL	325726.55N/1301554.33E	FSRF6	330723.80N/1301529.68E
LEENO	330223.31N/1301651.53E	FSRF7	330735.05N/1301520.05E
WEKKA	330612.58N/1301335.04E		
FS154	330742.91N/1301309.63E		
FS155	330900.65N/1301406.71E		
FS156	330919.21N/1301540.15E		
RW11	330904.20N/1301729.91E		
FS153	330340.13N/1301934.46E		
SGE	330855.03N/1301734.43E		

CHANGE: Update

INSTRUMENT APPROACH CHART

RJFS / SAGA

RNAV(RNP) RWY29

FUKUOKA RADAR 119.7 – 279.2	GNSS and RF required.	SAGA RADIO 118.025 – 126.2	2130–2300(UTC) 1030–1500 SAGA REMOTE 118.025	NO RADAR
--------------------------------	-----------------------	-------------------------------	---	----------

For uncompensated Baro-VNAV systems, procedure not authorized below -10°C / above 45°C

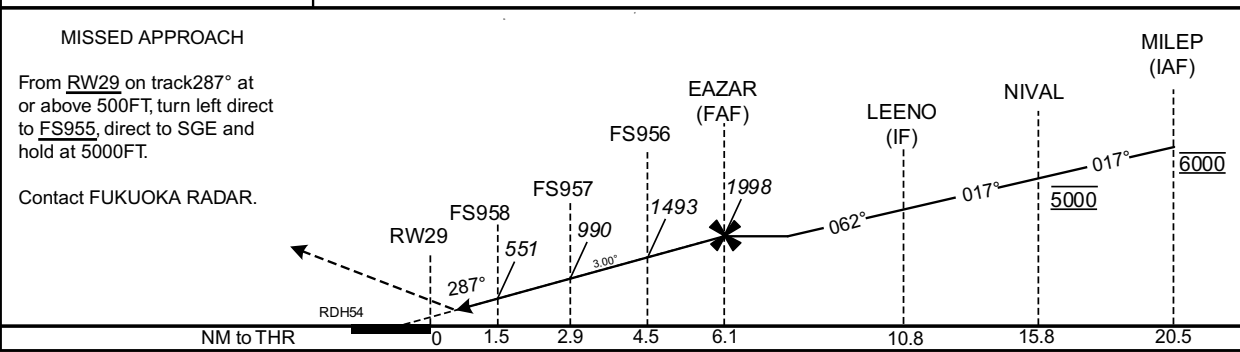
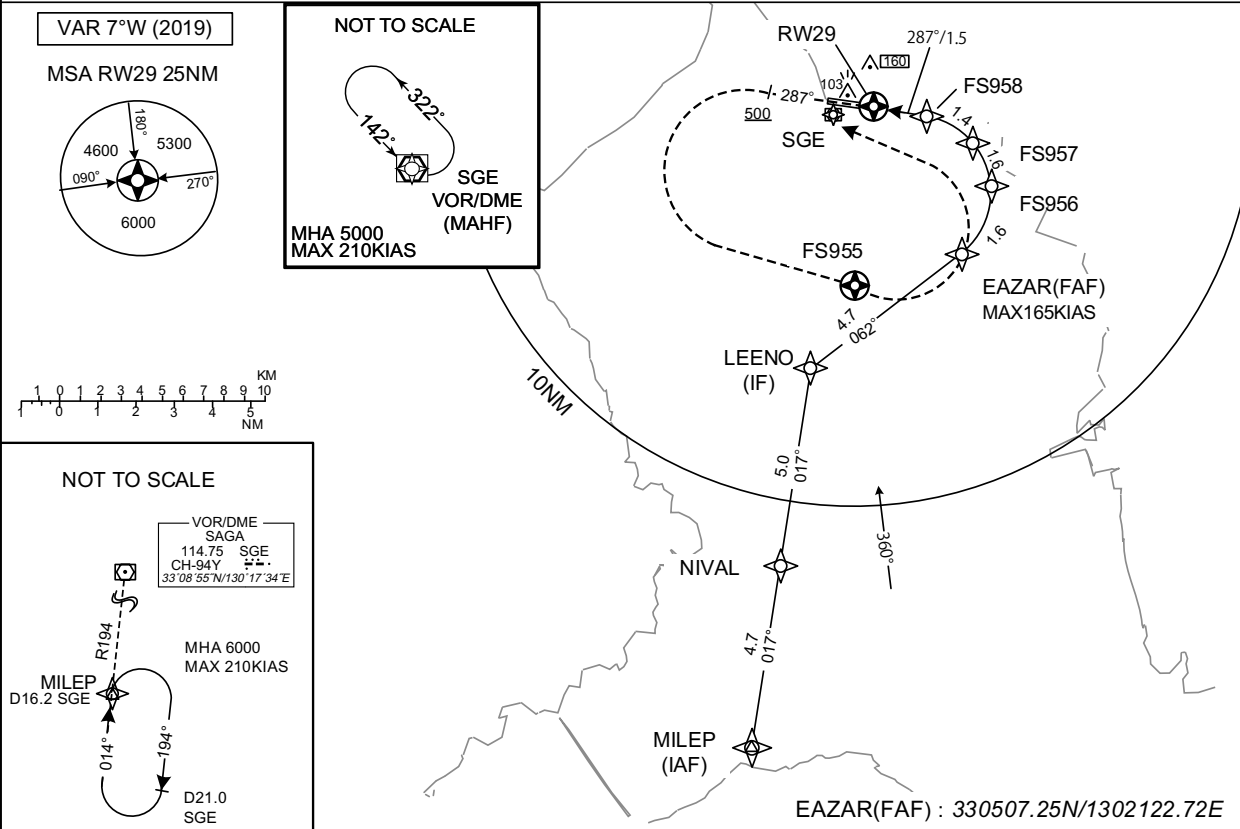

MINIMA	THR elev.6	AD elev.6
CAT	RNP 0.30	
	DA(H)	RVR/CMV
A	—	—
B	—	—
C	306 (300)	1000
D	—	1400

RNP AR
Special Authorization Required

CHANGE : ATC callsign changed (FUKUOKA DEP→FUKUOKA RADAR). ATC FREQ changed.

INSTRUMENT APPROACH CHART

RJFS / SAGA

RNAV(RNP) RWY29

RNAV(RNP) RWY29

Coding Table

Serial Number	Path Descriptor	Waypoint Identifier	Fly Over	Course °M(°T)	Magnetic Variation	Distance (NM)	Turn Direction	Altitude (FT)	Speed (KIAS)	VPA/RDH (°/FT)	RNP Value
001	IF	MILEP	-	-	-7.5	-	-	6000	-	-	-
002	TF	NIVAL	-	017 (009.2)	-7.5	4.7	-	5000	-	-	0.3
003	TF	LEENO	-	017 (009.2)	-7.5	5.0	-	-	-	-	0.3
004	TF	EAZAR	-	062 (054.2)	-7.5	4.7	-	1998	-165	-	0.3
005	RF Center: FSRF8 r=2.02NM	FS956	-	-	-7.5	1.6	L	1493	-	-3.00	0.3
006	RF Center: FSRF9 r=1.98NM	FS957	-	-	-7.5	1.6	L	990	-	-3.00	0.3
007	RF Center: FSRF0 r=1.75NM	FS958	-	-	-7.5	1.4	L	551	-	-3.00	0.3
008	TF	RW29	Y	287 (279.3)	-7.5	1.5	-	60	-	-3.00/54	0.3
009	FA	-	-	287 (279.3)	-7.5	-	-	+500	-	-	1.0
010	DF	FS955	Y	-	-7.5	-	L	-	-	-	1.0
011	DF	SGE	-	-	-7.5	-	L	5000	-	-	1.0

Waypoint Coordinates

Waypoint Identifier	Coordinates	RF Arc Center Identifier	Coordinates
MILEP	325250.49N/1301501.22E	FSRF8	330645.72N/1301958.78E
NIVAL	325726.55N/1301554.33E	FSRF9	330646.63N/1302001.15E
LEENO	330223.31N/1301651.53E	FSRF0	330654.73N/1302014.52E
EAZAR	330507.25N/1302122.72E		
FS956	330626.19N/1302220.91E		
FS957	330756.35N/1302156.32E		
FS958	330838.87N/1302034.72E		
RW29	330853.77N/1301846.08E		
FS955	330424.77N/1301815.75E		
SGE	330855.03N/1301734.43E		

CHANGE: Update

STANDARD ARRIVAL CHART-INSTRUMENT

RJFS / SAGA

STAR

IRPIN NORTH ARRIVAL

From over IRPIN, via OLE R102 to MILEP, via SGE R194 to SGE VOR/DME via UGAMU.
Cross MILEP at 6000FT, cross SGE VOR/DME at or above 5000FT.

IRPIN SOUTH ARRIVAL

From over IRPIN, via OLE R102 to MILEP.
Cross MILEP at 6000FT.

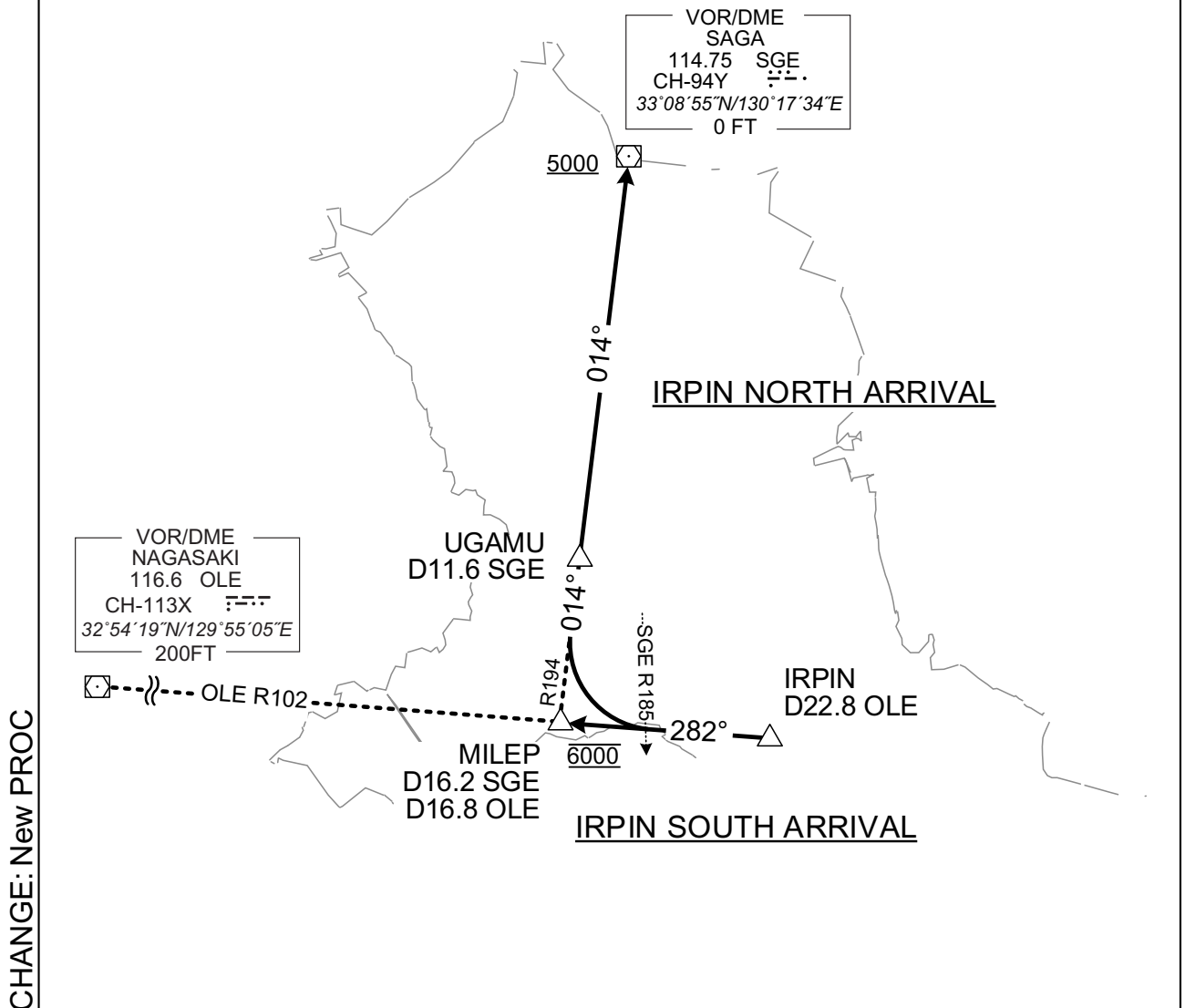

INTENTIONALLY LEFT BLANK

INSTRUMENT APPROACH CHART

RJFS/SAGA

VOR A

FUKUOKA RADAR 119.7 – 279.2	SAGA VOR/DME 114.75 SGE CH-94Y 33°08'55"N/130°17'34"E	SAGA RADIO 118.025 – 126.2 SAGA REMOTE 118.025	(2130–2300(UTC) 1030–1500)	NO RADAR
--------------------------------	--	---	-------------------------------	----------

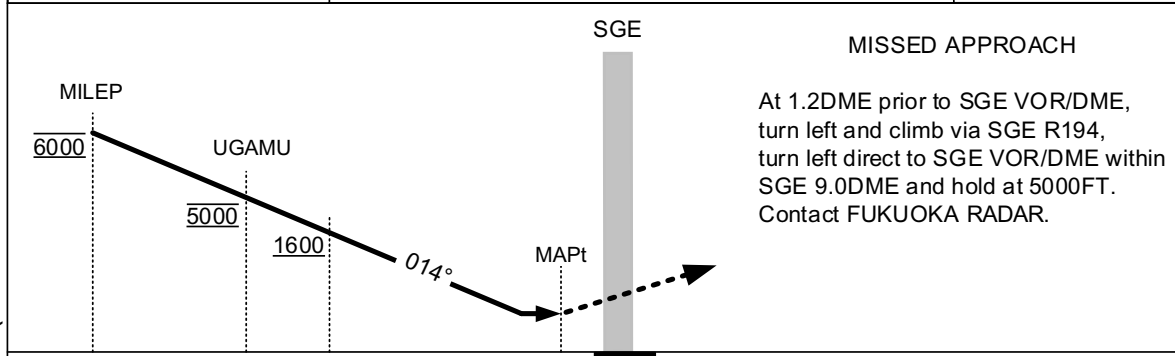
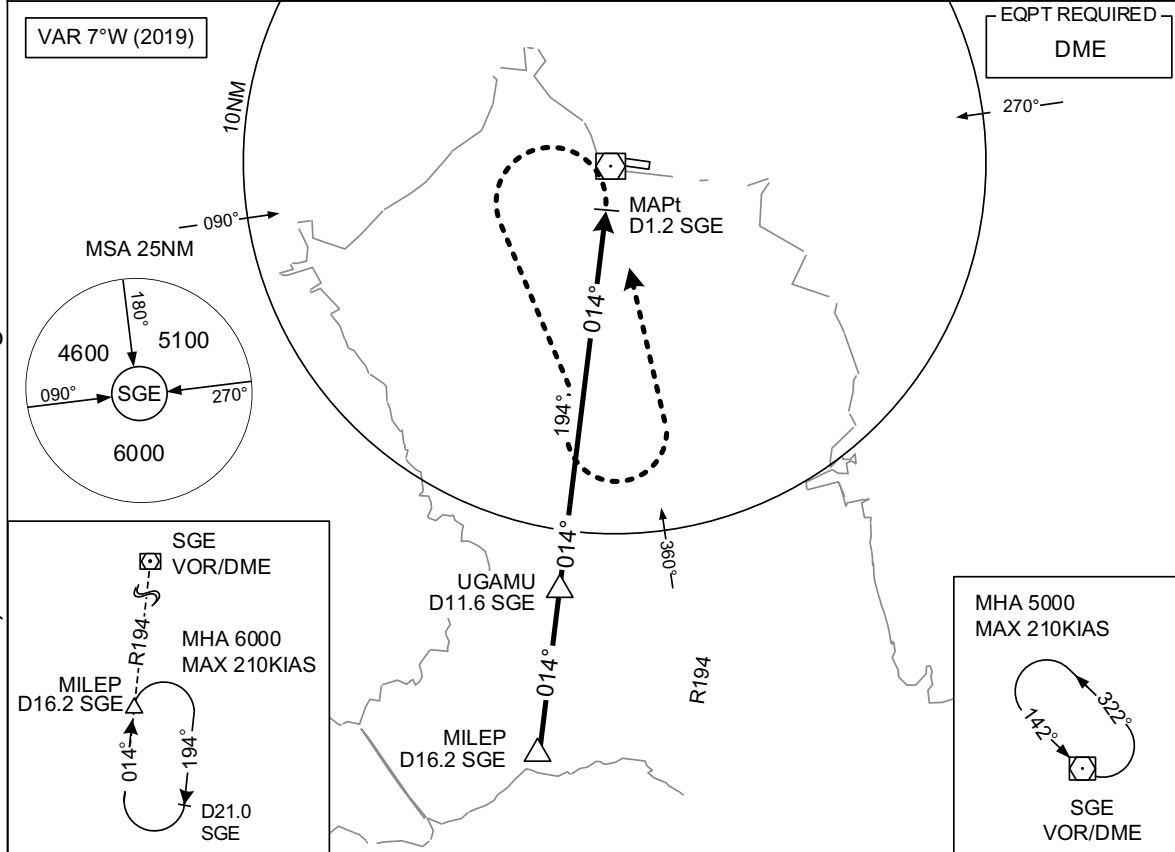

MINIMA		AD elev. 6	
CAT	CIRCLING		
	MDA(H)	VIS	
A	360(354)	1600	
B	460(454)	2400	
C		2400	
D	560(554)	3200	

Circling to SOUTH side of RWY only.

CHANGE : ATC callsign changed (FUKUOKA DEP→FUKUOKA RADAR). ATC FREQ changed.

INSTRUMENT APPROACH CHART

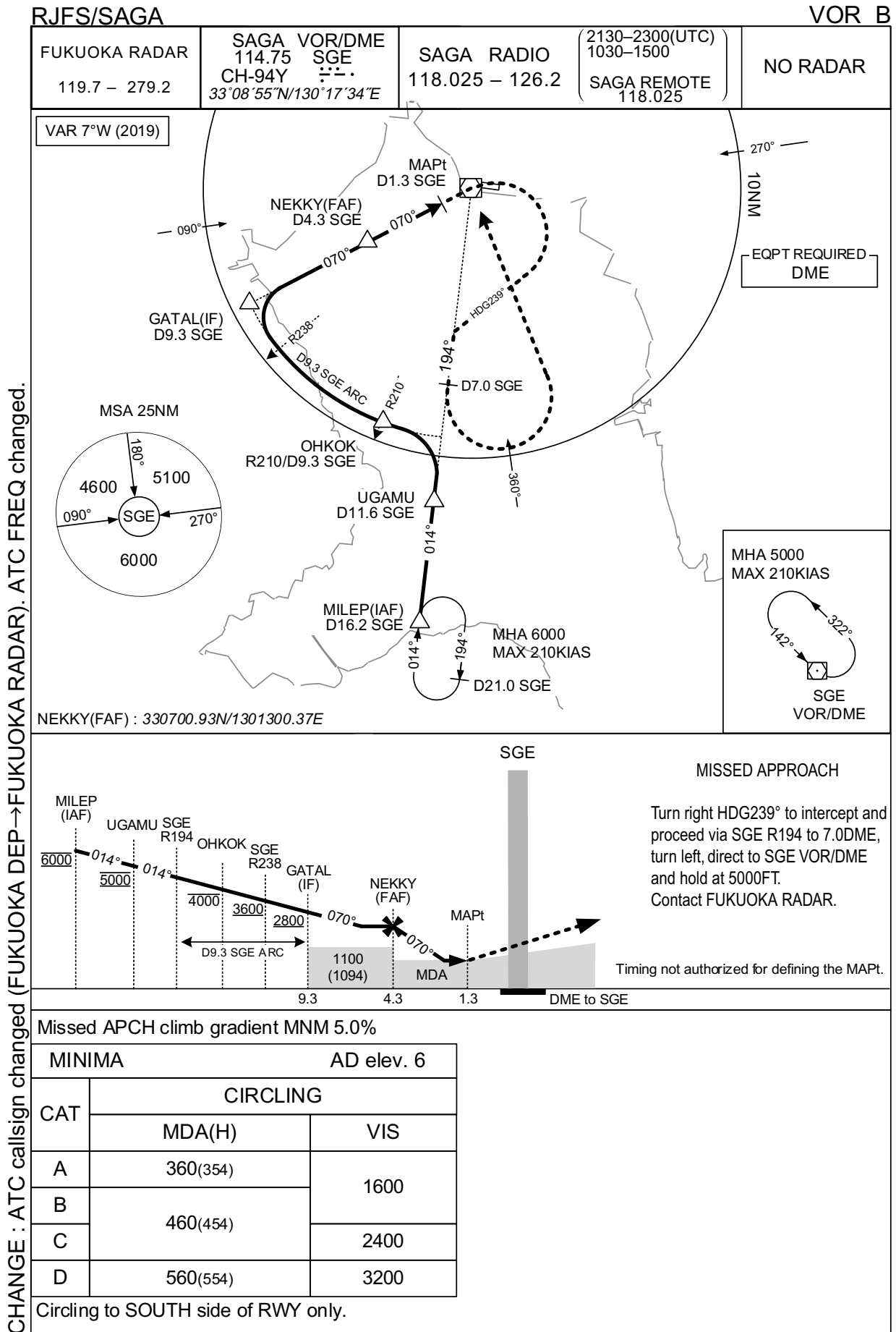

INSTRUMENT APPROACH CHART

RJFS/SAGA

VOR C

FUKUOKA RADAR 119.7 – 279.2	SAGA VOR/DME 114.75 SGE CH-94Y 33°08'55"N/130°17'34"E	SAGA RADIO 118.025 – 126.2	(2130–2300(UTC) 1030–1500 SAGA REMOTE 118.025	NO RADAR
--------------------------------	--	-------------------------------	--	----------

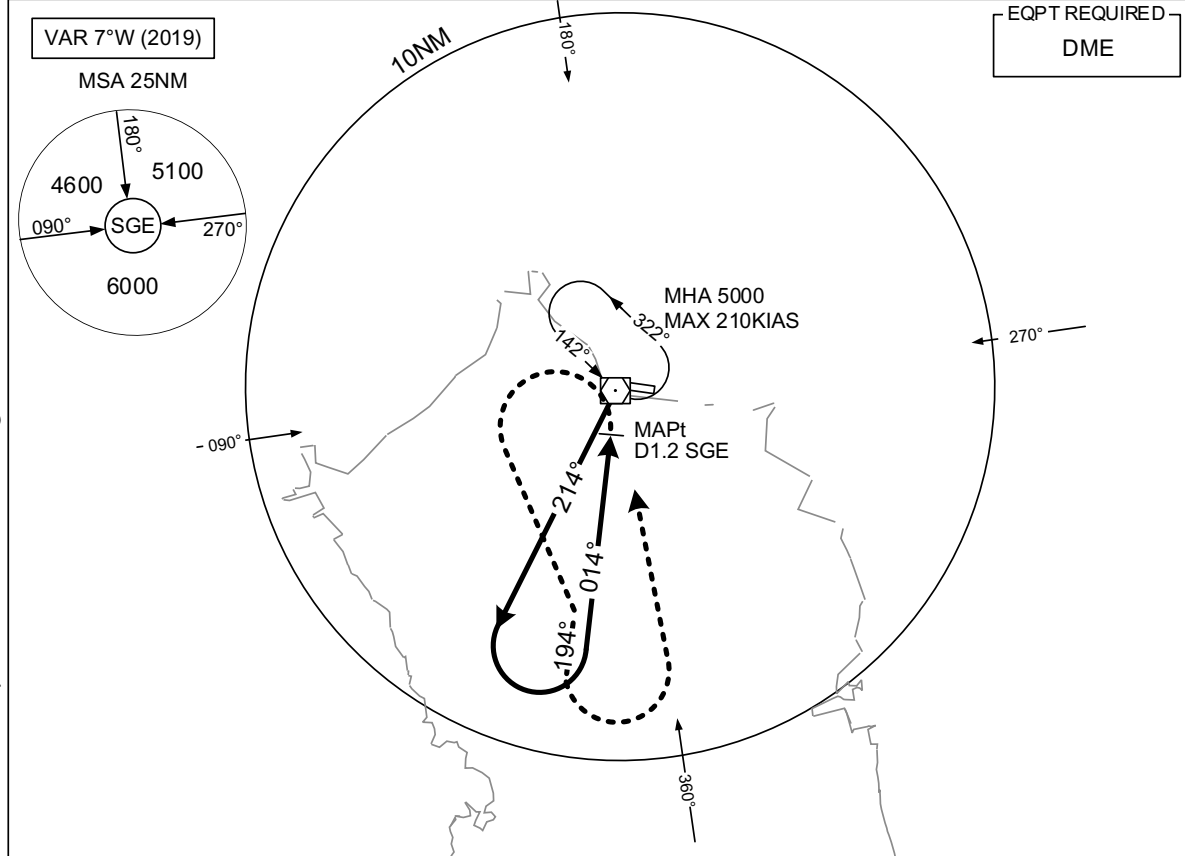

EQPT REQUIRED
DME

CHANGE : ATC callsign changed (FUKUOKA DEP→FUKUOKA RADAR). ATC FREQ changed.

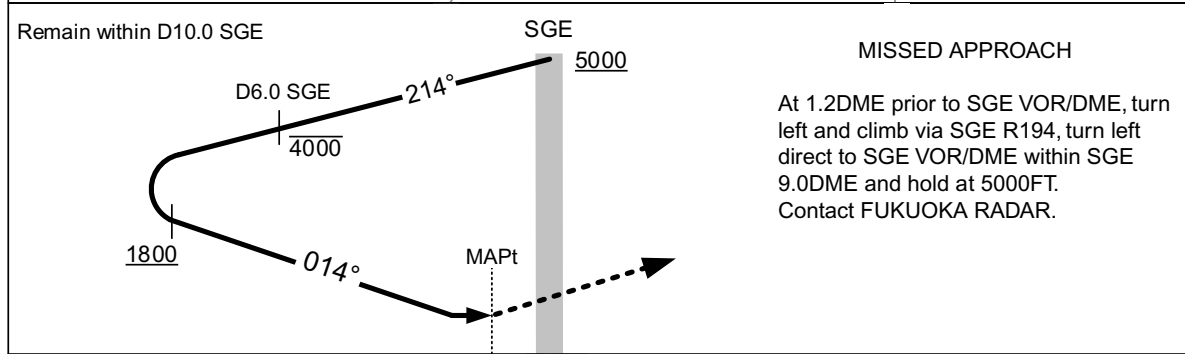

MISSED APPROACH

At 1.2DME prior to SGE VOR/DME, turn left and climb via SGE R194, turn left direct to SGE VOR/DME within SGE 9.0DME and hold at 5000FT. Contact FUKUOKA RADAR.

MINIMA		AD elev. 6	
CAT	CIRCLING		
	MDA(H)	VIS	
A	360(354)	1600	
B	460(454)		
C		2400	
D	560(554)	3200	

Circling to SOUTH side of RWY only.

STANDARD DEPARTURE CHART - INSTRUMENT

RJFS / SAGA

SID

SAGA REVERSAL TWO DEPARTURE

RWY11 : Climb RWY HDG to 500FT, turn right,...
RWY29 : Climb RWY HDG to 500FT, turn left HDG 090° to intercept and proceed...
...via SGE R135 to 9.0DME, turn left, direct to SGE VOR/DME.
Cross SGE VOR/DME at 6000FT.

Note RWY29 : 3.5% climb gradient required up to 500FT.

ARIAKE REVERSAL TWO DEPARTURE

RWY11 : Climb RWY HDG to 500FT, turn right HDG 288° ...
RWY29 : Climb RWY HDG to 500FT, turn left HDG 198° ...
...to intercept and proceed via SGE R243 to 7.0DME, turn right, direct to SGE VOR/DME.
Cross SGE VOR/DME at or above 6000FT.

Note RWY29 : 3.5% climb gradient required up to 500FT.

ARIAKE REVERSAL
TWO DEPARTURE

SAGA REVERSAL
TWO DEPARTURE

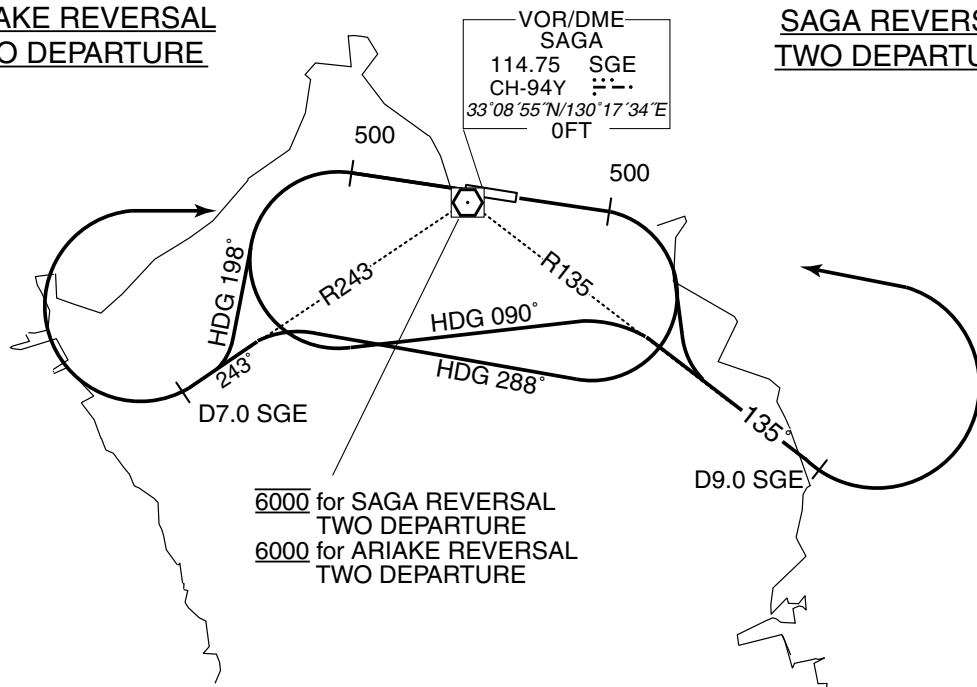

STANDARD DEPARTURE CHART - INSTRUMENT

RJFS / SAGA

TRANSITION

KUMAMOTO TRANSITION

From over SGE VOR/DME, via SGE R195 to 18.0DME, turn left, via KUE R271 to KUE VOR/DME.

Cross SGE R195/6.0DME at 6000FT, cross SGE R195/18.0DME at or above 10000FT.

NAGASAKI TRANSITION

From over SGE VOR/DME, via SGE R195 to 18.0DME, turn right, direct to OLE VOR/DME.

Cross SGE R195/6.0DME at 6000FT, cross SGE R195/18.0DME at or above 10000FT.

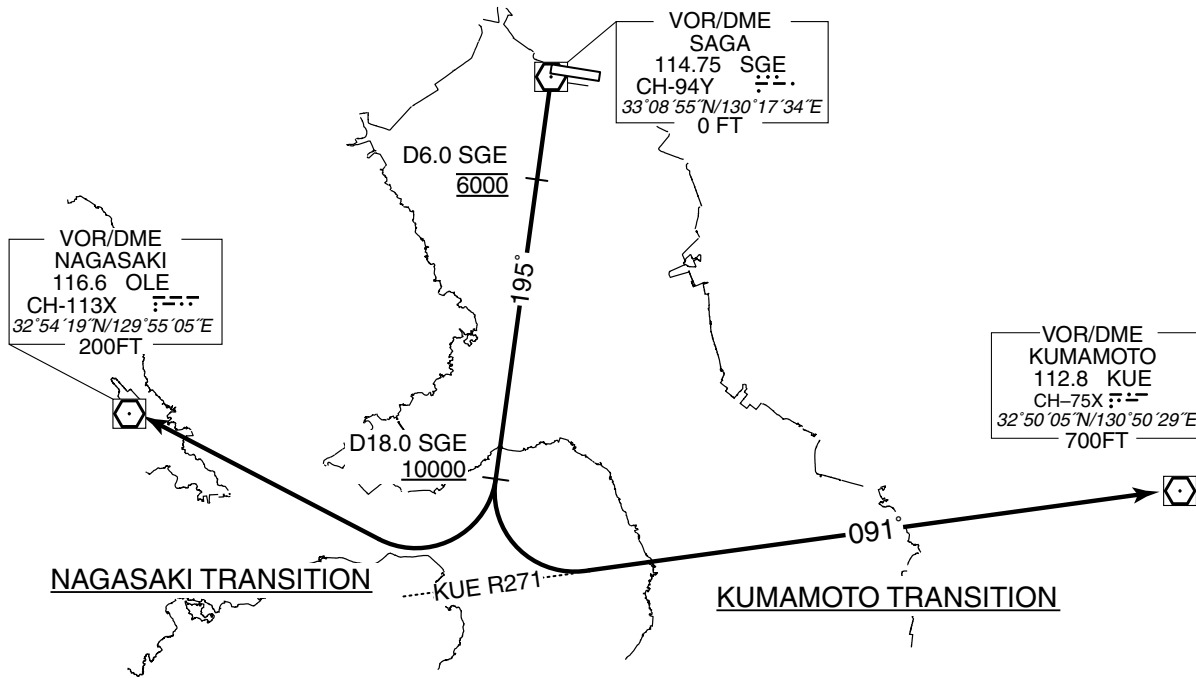

STANDARD DEPARTURE CHART - INSTRUMENT

RJFS / SAGA

SID

KIKYU FIVE DEPARTURE

RWY11 : Climb RWY HDG to 500FT, turn right,...

RWY29 : Climb RWY HDG to 500FT, turn left HDG075° to intercept and proceed...
... via SGE R120 to 9.0DME, turn left HDG048° to intercept
and proceed via SGE R093 to KIKYU.

Cross KIKYU at or above 13000FT.

Note RWY29 : 3.5% climb gradient required up to 500FT.

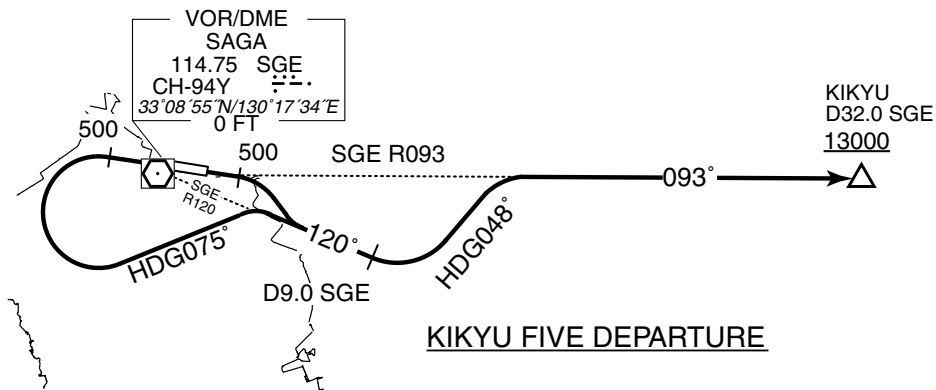

STANDARD DEPARTURE CHART - INSTRUMENT

RJFS / SAGA

TRANSITION

MUSASHI TRANSITION

From over KIKYU, via TFE R253 to TFE VOR/DME.

Cross TFE R253/38.0DME at or above FL140, cross TFE R253/31.0DME at or above FL170.

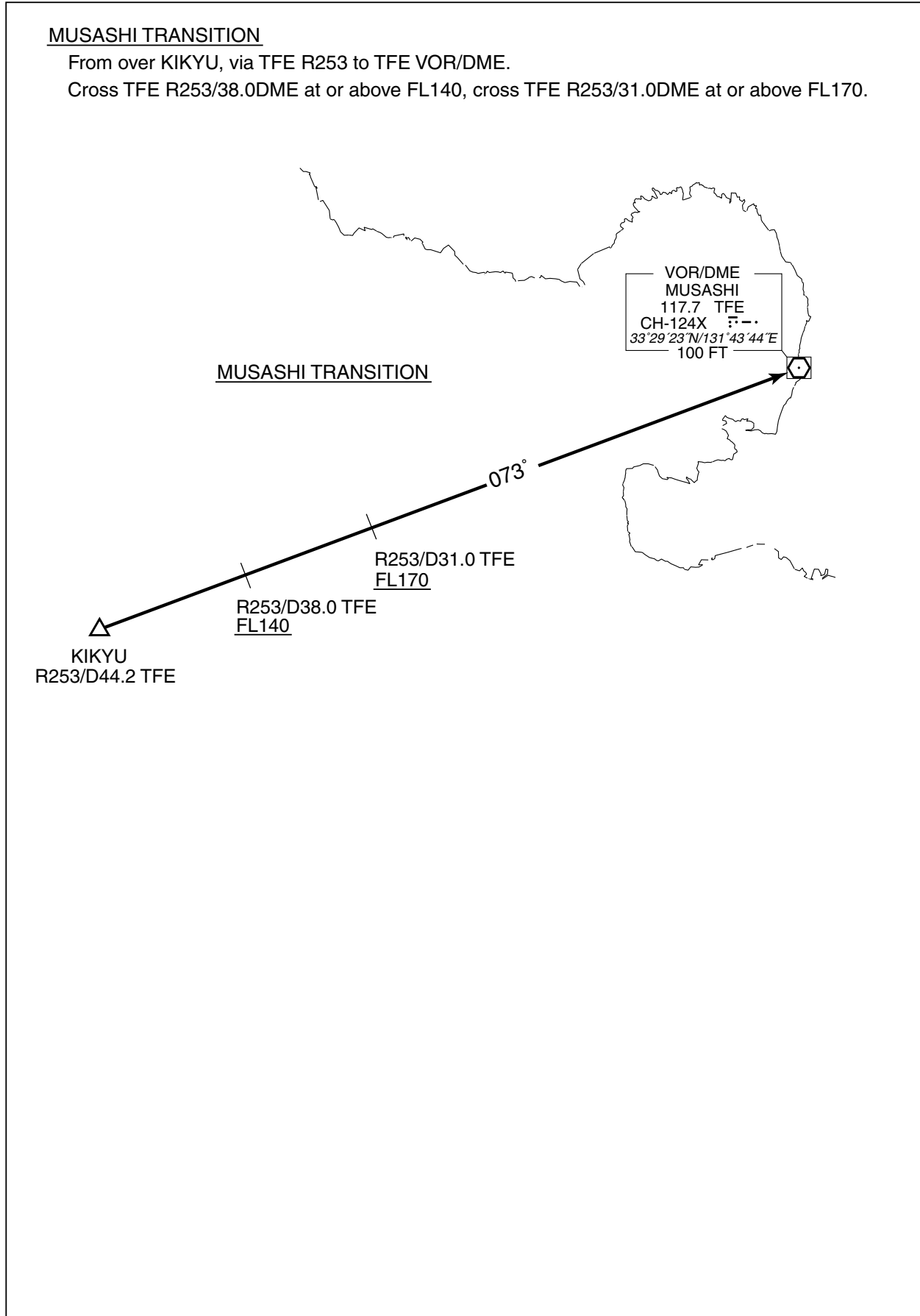

STANDARD DEPARTURE CHART - INSTRUMENT

RJFS / SAGA

RNAV TRANSITION

OOITA TRANSITION		RNAV1
NOTE 1) DME/DME/IRU or GNSS required. 2) RADAR service required.	Critical DME	-
	DME GAP	-
	Inappropriate Navaids	See AD1.1.6.10.3. Inappropriate NAVAIDs for RNAV1

VAR 7° W(2016)

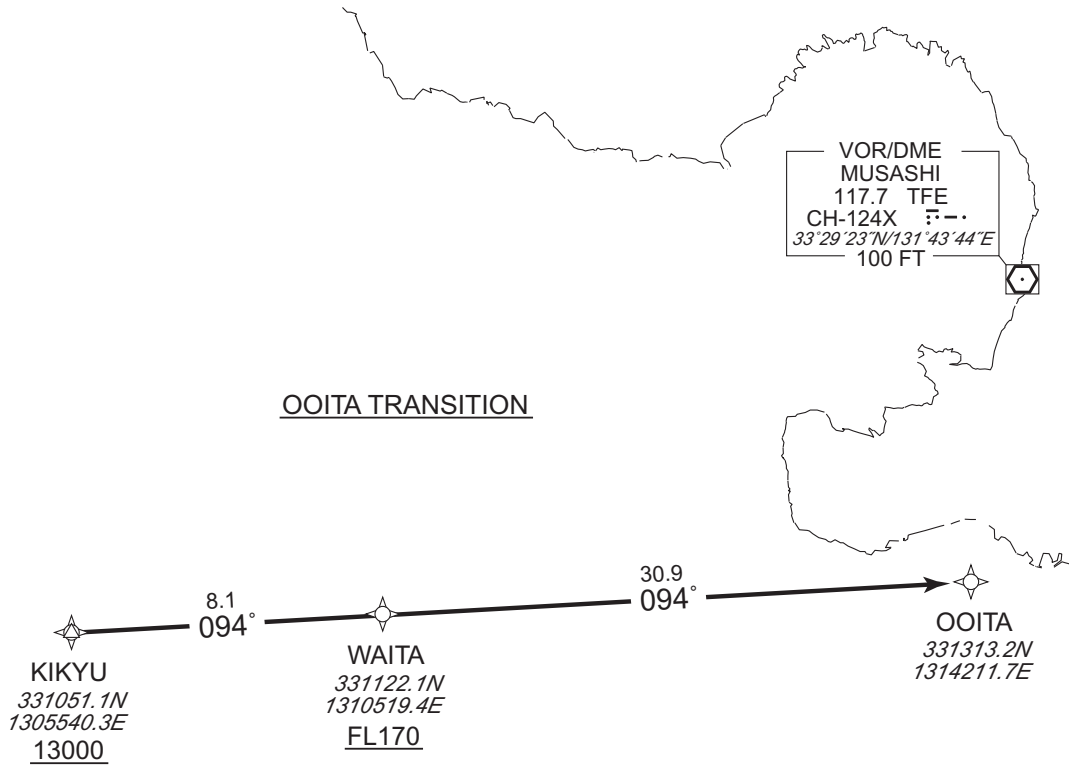

OOITA TRANSITION

From KIKYU at or above 13000FT, to WAITA at or above FL170, to OOITA.

Serial Number	Path Descriptor	Waypoint Identifier	Fly Over	Course °M(°T)	Magnetic Variation	Distance (NM)	Turn Direction	Altitude (FT)	Speed (KIAS)	Vertical Angle	Navigation Specification
001	IF	KIKYU	-	-	-7.2	-	-	+13000	-	-	RNAV1
002	TF	WAITA	-	094 (086.3)	-7.2	8.1	-	+FL170	-	-	RNAV1
003	TF	OOITA	-	094 (086.4)	-7.2	30.9	-	-	-	-	RNAV1

INTENTIONALLY LEFT BLANK

INSTRUMENT APPROACH CHART

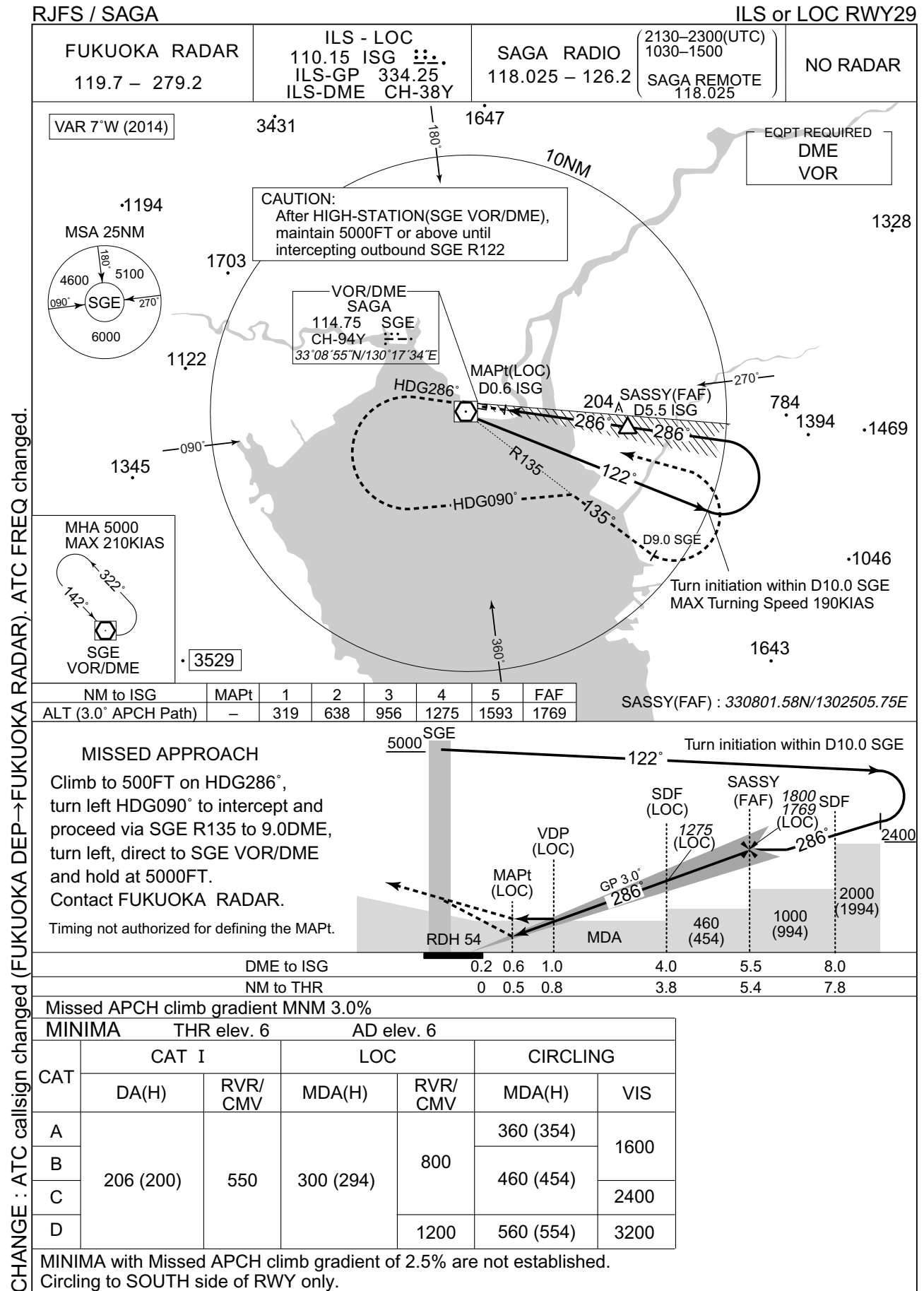

INSTRUMENT APPROACH CHART

RJFS / SAGA

VOR RWY29

FUKUOKA RADAR
119.7 – 279.2

SAGA VOR/DME
114.75 SGE
CH-94Y
33°08'55"N/130°17'34"E

SAGA RADIO (2130-2300(UTC)
1030-1500)
118.025 – 126.2
SAGA REMOTE
118.025

NO RADAR

VAR 7°W (2014)

3431

1647

EQPT REQUIRED
DME

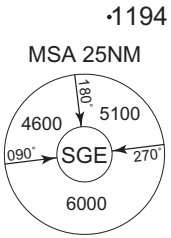

CAUTION:
After HIGH-STATION(SGE VOR/DME),
maintain 5000FT or above until
intercepting outbound SGE R118

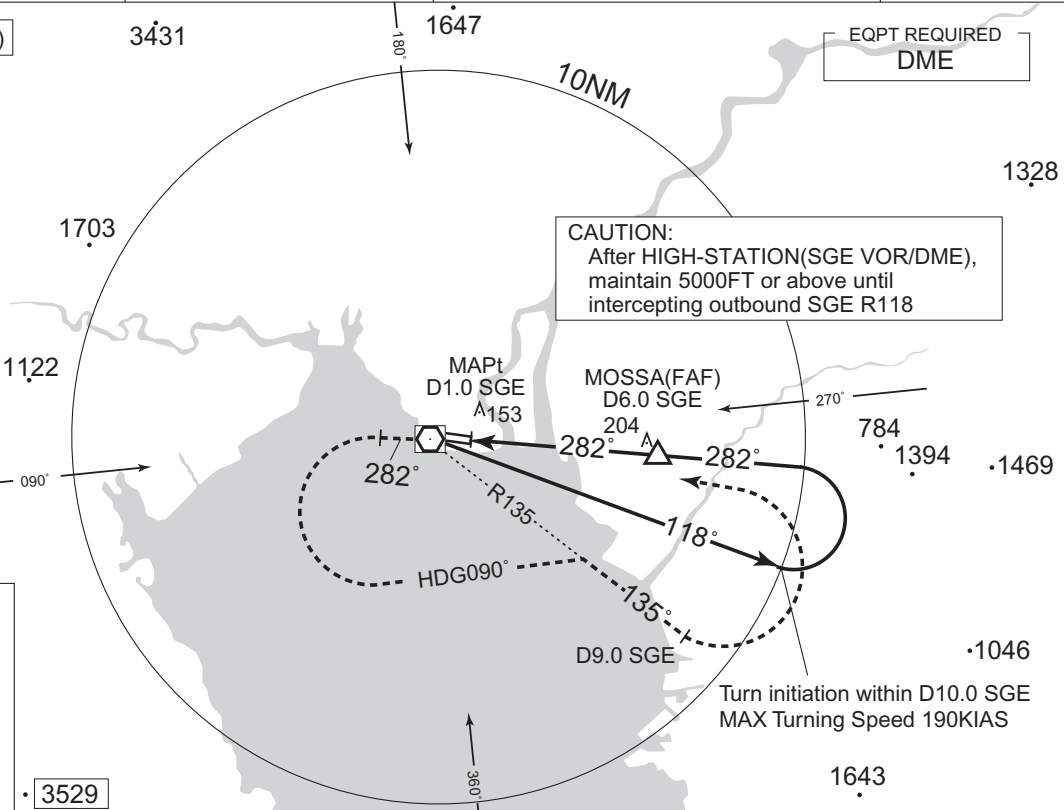
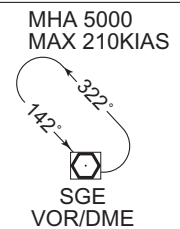

NM to SGE	MAPt	2	3	4	5	FAF
ALT (3.0° APCH Path)	-	374	693	1011	1330	1648

MOSSA(FAF) : 330825.59N/1302441.67E

MISSED APPROACH

Climb to 500FT via SGE R282,
turn left HDG090° to intercept and
proceed via SGE R135 to 9.0DME,
turn left, direct to SGE VOR/DME
and hold at 5000FT.
Contact FUKUOKA RADAR.

Timing not authorized for defining the MAPt.

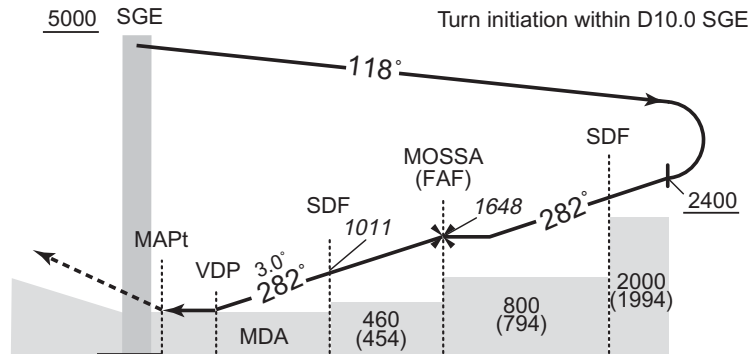

DME to SGE	1.0	1.9	4.0	6.0	9.0
NM to THR	0	0.9	3.0	5.0	8.0

MINIMA		THR elev. 6	AD elev. 6	
CAT			CIRCLING	
	MDA(H)	RVR/ CMV	MDA(H)	VIS
A	320 (314)	900	360 (354)	1600
B		1000	460 (454)	
C			2400	
D			1400	560 (554)

Circling to SOUTH side of RWY only.

CHANGE : ATC callsign changed (FUKUOKA DEP→FUKUOKA RADAR). ATC FREQ changed.

INSTRUMENT APPROACH CHART

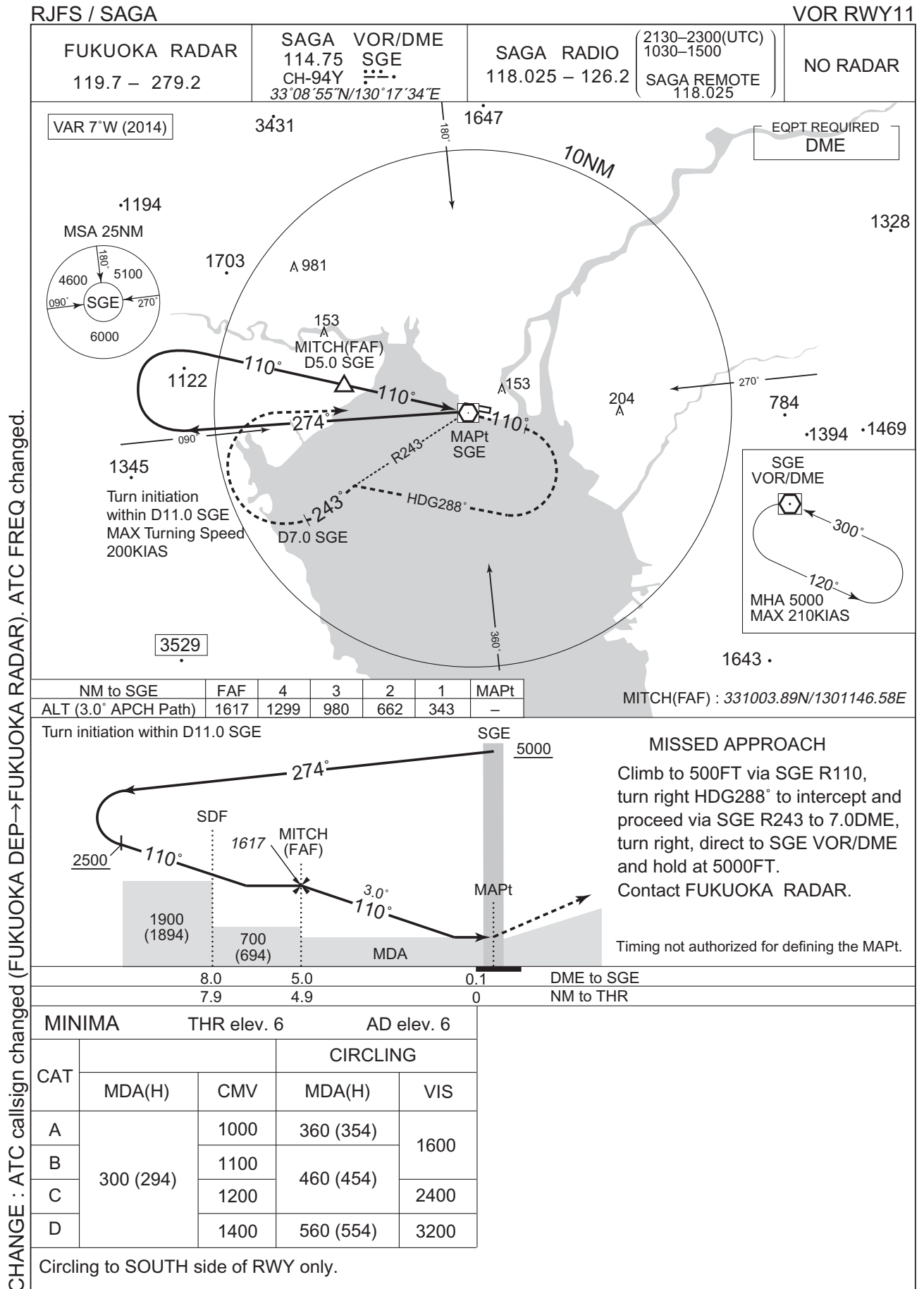

RJFS / SAGA

Minimum Vectoring Altitude CHART

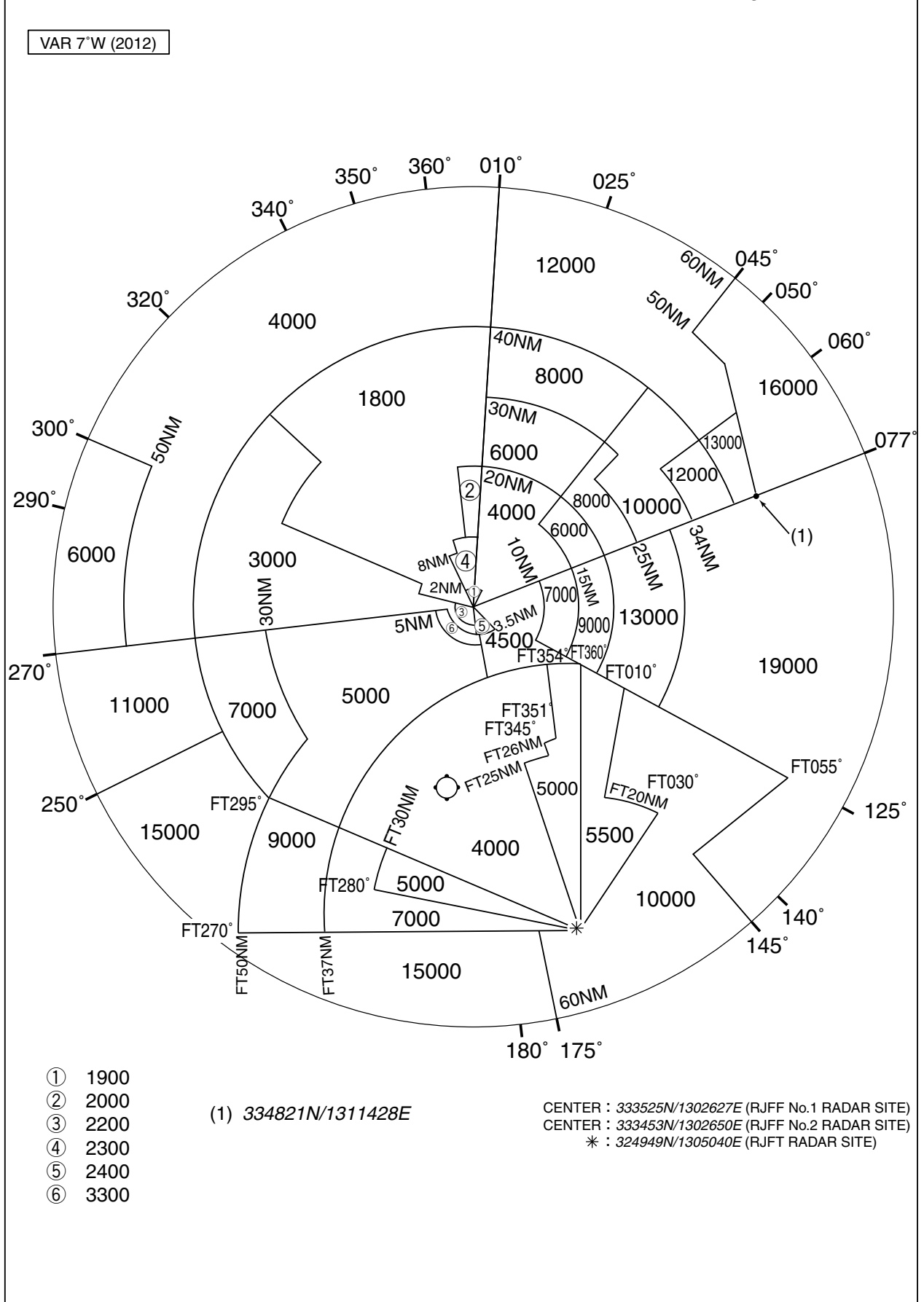

RJFS / SAGA

Visual REP



Call sign	BRG / DIST from ARP	Remarks
鹿島 Kashima	250°/ 9.9NM	新浜大橋 Bridge
竹崎 Takezaki	199°/12.3NM	竹崎港 Harbor
大牟田 Ohmuta	135°/10.1NM	JR大牟田駅 Station
筑後 Chikugo	071°/11.8NM	八女インターチェンジ Interchange
大中島 Ohnakashima	038°/ 5.0NM	筑後川昇開橋 Bridge
久保田 Kubota	329°/ 5.0NM	久保田橋 Bridge
佐賀大和 Sagayamato	354°/10.5NM	佐賀大和インターチェンジ Interchange
南関 Nankan	111°/13.2NM	南関インターチェンジ Interchange
10NM S	180°/10.0NM	海上 Over the sea



RJFS / SAGA

BALLOON

熱気球の飛行が下図区域内で行われる。(期間：5月中旬から6月中旬まで及び10月中旬から2月下旬まで：RJFSノータム参照)

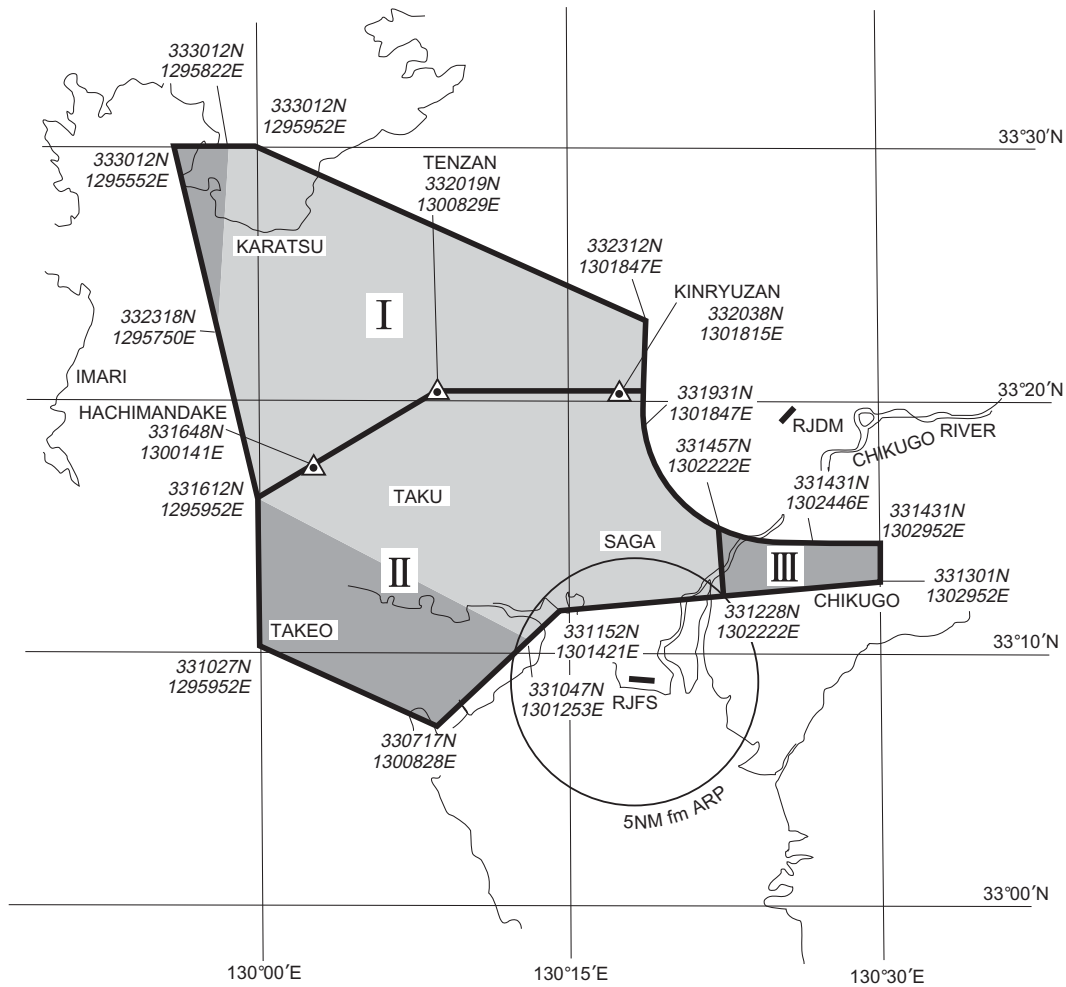
Hot air balloon flight will be conducted within below area.
(Period: from mid MAY to mid JUN and from mid OCT to late FEB: see NOTAM RJFS)



 飛行高度 3000ft 以下 FLT ALT At or below 3000ft	 飛行高度 4000ft 以下 FLT ALT At or below 4000ft
--	--

 Balloon FLT area Nr1	 Balloon FLT area Nr2*	 Balloon FLT area Nr3*
--	---	--

* 佐賀空港を発着する航空機に対し、熱気球に係る情報(飛行空域2及び3内で飛行する気球の概数等)の提供が佐賀メディアまたは佐賀県庁により行われる。
 * The information of hot air balloon(aprx number of balloon etc.in flight area number 2 and 3) will be provided for departing/arriving acft from/to SAGA airport by SAGA RADIO or SAGA REMOTE.
 Example of phraseology:"Two flying balloons reported in balloon flight area number two."

CHANGE : NOTAM location (RJFF→RJFS).

SAGA AP

ILS

ILS-LOC
ANTENNA

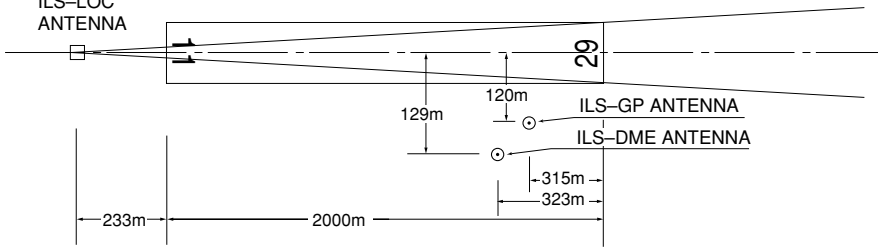

REMARKS	: 1. LOC beam BRG(MAG)	286°
	2. HGT of ILS REF datum	16.5m(54ft)
	3. GP Angle	3.0°
	4. ELEV of ILS-DME	6.6m(22ft)

B767型機用の滑走路180°転回実施要項

1. 滑走路中心線からターニングパッド中心線標識に従って進行する。
2. 転回灯1が一直線に見えるように進行し、転回灯2が一直線に見えたとき転回を開始する。転回時はMAX STEERING ANGLEを使用する。

180°turn procedure on RWY for B767 aircraft

1. Proceed along the RWY Center Line to the starting point of the RWY Turn Pad Centerline Marking ; then
2. Proceed along RWY Turn Pad Center Line Marking to see the Turning Point Indicator Light 1 on a straight line, then commence turn at the spot where you (pilot)can see the Turning Point Indicator Lights 2 on a straight line at an angle of 9 o'clock. When turning, take MAX STEERING ANGLE.

SAGA AP

