

AD 2 AERODROMES

RJFR AD 2.1 AERODROME LOCATION INDICATOR AND NAME

RJFR - KITAKYUSHU

RJFR AD 2.2 AERODROME GEOGRAPHICAL AND ADMINISTRATIVE DATA

1	ARP coordinates and site at AD	335044N/1310206E 170° / 1.25km from RWY 18 THR
2	Direction and distance from (city)	8NM(15km) SE from Kokura Station
3	Elevation/ Reference temperature	21ft / -
4	Geoid undulation at AD ELEV PSN	107ft
5	MAG VAR/ Annual change	7° W (2005) / 0.9'W
6	AD Administration, address, telephone, telefax, telex, AFS, e-mail and/or Web-site addresses	KITAKYUSHU AIRPORT OFFICE (CIVIL AVIATION BUREAU) 6 Kukuokitamachi, Kokuraminami-ward, Kitakyushu-city, Fukuoka Pref. 800-0306 Japan Tel: 093-473-1089, Fax:093-473-9417
7	Types of traffic permitted (IFR/VFR)	IFR/VFR
8	Remarks	Nil

RJFR AD 2.3 OPERATIONAL HOURS

1	AD Administration	H24
2	Customs and immigration	Customs: On request(093-332-8349) Immigration: INTL SKED FLT hours only
3	Health and sanitation	INTL SKED FLT hours only
4	AIS Briefing Office	H24
5	ATS Reporting Office(ARO)	Nil
6	MET Briefing Office	H24 (FUKUOKA)
7	ATS	H24
8	Fuelling	H24
9	Handling	H24
10	Security	H24
11	De-icing	Nil
12	Remarks	Nil

RJFR AD 2.4 HANDLING SERVICES AND FACILITIES

1	Cargo-handling facilities	All the modern institutions that deal with the weight thing to A306 type freighter.
2	Fuel/ oil types	Fuel grades: Jet A1, AVGAS 100LL Oil grades: All grades
3	Fuelling facilities/ capacity	Fuel truck refueling / Not limitation
4	De-icing facilities	Nil
5	Hangar space for visiting aircraft	Nil
6	Repair facilities for visiting aircraft	Nil
7	Remarks	Nil

RJFR AD 2.5 PASSENGER FACILITIES

1	Hotels	At Kitakyushu city
2	Restaurants	At Airport
3	Transportation	Buses and Taxi
4	Medical facilities	First aid treatment, ambulance:Hospital in Kitakyushu city 4km
5	Bank and Post Office	At Kitakyushu city
6	Tourist Office	At Kitakyushu city
7	Remarks	Nil

RJFR AD 2.6 RESCUE AND FIRE FIGHTING SERVICES

1	AD category for fire fighting	CAT 9
2	Rescue equipment	Chemical fire fighting truck × 3 Water-supply truck × 1 Lighting power supply truck × 1 Emergency medical equipments conveyance truck × 1
3	Capability for removal of disabled aircraft	Nil
4	Remarks	Nil

RJFR AD 2.7 SEASONAL AVAILABILITY-CLEARING

1	Types of clearing equipment	Snow remove equipments: Motor grader × 4
2	Clearance priorities	1) RWY18/36 TWY T1, T6, P1, P2, P3, P4, P5 2) TWY T2, T5 3) North Apron, South Apron (Small Aircraft Apron)
3	Remarks	Snow removal will be commenced, if the RWY are covered with a depth of 3cm snow or more.

RJFR AD 2.8 APRONS, TAXIWAYS AND CHECK LOCATIONS DATA

1	Apron surface and strength	North Apron: Surface: cement-concrete, Strength: PCN 74/R/B/X/T South Apron (Small Aircraft Apron): Surface: asphalt-concrete, Strength: PCN 14/F/C/Y/T
2	Taxiway width, surface and strength	TWY T1, T6 Width: 32m, Surface: asphalt-concrete, Strength: PCN 83/F/B/X/T TWY T2, T3, T4, T5 Width: 34m, Surface: asphalt-concrete, Strength: PCN 83/F/B/X/T TWY P1, P2, P3, P5 Width: 30m, Surface: asphalt-concrete, Strength: PCN 83/F/B/X/T TWY P4 Width: 30m, Surface: cement-concrete, Strength: PCN 74/R/B/X/T
3	ACL and elevation	Location: North Apron Elevation: 19ft
4	VOR checkpoints	Not available
5	INS checkpoints	Spot NR 0 : 335028.75N 1310155.57E 5A : 335019.61N 1310159.65E 1 : 335026.94N 1310155.93E 5B : 335018.41N 1310158.92E 2 : 335025.34N 1310156.26E 6 : 335016.67N 1310158.00E 3 : 335023.23N 1310156.69E 7 : 335015.38N 1310158.26E 4 : 335021.12N 1310157.12E 90 : 335033.13N 1310154.17E 5 : 335019.21N 1310157.51E
6	Remarks	Nil

RJFR AD 2.9 SURFACE MOVEMENT GUIDANCE AND CONTROL SYSTEM AND MARKINGS

1	Use of aircraft stand ID signs, TWY guide lines and Visual docking/ parking guidance system of aircraft stands	ACFT stand identification signs: NR 2-4 TWY guide line: Nil Visual docking guidance system: Nil
2	RWY and TWY markings and LGT	RWY: RWY 18/36 (Marking): RWY designation, RWY CL, RWY THR, RWY middle point, Aiming point, TDZ, RWY side stripe (LGT): REDL, RCLL, RTZL, RTHL, RENL, WBAR TWY: T1 - T6 (Marking): TWY CL, RWY HLDG PSN, TWY side stripe, Mandatory instruction marking (LGT): TWY edge LGT, TWY CL LGT, Taxiing guidance sign, RWY guard LGT TWY: P1 - P5 (Marking): TWY CL, TWY side stripe (LGT): TWY edge LGT, TWY CL LGT
3	Stop bars	Stop Bar Lights: T1 - T6 Stop Bar Lights operations 1) Stop Bar Lights are installed at each RWY holding position associated with RWY 18/36. 2) Stop Bar Lights will be operated during operating hours of ATC Service. 3) Stop Bar Lights will be operated when the visibility or the lowest RVR of the RWY 18/36 is at or less than 600m. 4) Stop Bar Lights on TWY T1 and T6 are controlled individually by ATC. 5) Stop Bar Lights on TWY T2 through T5 are not controlled individually by ATC. 6) During the period Stop Bar Lights operated, TWY T2 through T5 are not available for departure aircraft.
4	Remarks	(Marking): Overrun area, ACFT parking position and Aircraft stand taxi lane. (LGT): Apron flood LGT

RJFR AD 2.10 AERODROME OBSTACLES

In approach/TKOF areas

RWY/Area affected	Obstacle type	Coordinates	Elevation	Markings/ LGT	Remarks
See AD2.24 LDG CHART					

In circling area and at AD

Obstacle type	Coordinates	Elevation	Markings/ LGT	Remarks
Bridge	334921N/1310117E	51.1m	-/LIL	

RJFR AD 2.11 METEOROLOGICAL INFORMATION PROVIDED

1	Associated MET Office	FUKUOKA
2	Hours of service MET Office outside hours	H24 (FUKUOKA)
3	Office responsible for TAF preparation Periods of validity	FUKUOKA 30 Hours
4	Trend forecast Interval of issuance	Nil
5	Briefing/ consultation provided	Briefing is available upon inquiry at FUKUOKA
6	Flight documentation Language(s) used	C En
7	Charts and other information available for briefing or consultation	S ₆ , U ₈₅ , U ₇ , U ₅ , U ₃ , U ₂₅ , P _S , P ₅ , P ₃ , P ₂₅ , P _{SWE} , P _{SWF} , P _{SWG} , P _{SWI} , P _{SWM} , P _{SW} , (domestic), U _{2/T} , E, C, W _E , W _F , W _G , W _I , W, N
8	Supplementary equipment available for providing information	Nil
9	ATS units provided with information	TWR / REMOTE
10	Additional information (limitation of service, etc.)	Nil

RJFR AD 2.12 RUNWAY PHYSICAL CHARACTERISTICS

Designations RWY NR	TRUE BRG	Dimensions of RWY(M)	Strength(PCN) and surface of RWY	THR coordinates THR geoid undulation	THR elevation and highest elevation of TDZ of precision APP RWY
1	2	3	4	5	6
18	170.35°	2500×60	PCN 83/F/B/X/T Asphalt-Concrete	335123.92N 1310157.83E 107ft	THR ELEV: 22ft TDZ ELEV: 22ft
36	350.35°	2500×60	PCN 83/F/B/X/T Asphalt-Concrete	335004.08N 1310214.17E 107ft	THR ELEV: 23ft

Slope of RWY	Strip Dimensions (M)	RESA (Overrun) Dimensions(M)	Remarks
7	10	11	14
See Below Chart	2620×300	189 × (MNM:120 MAX:300)*	RWY grooving: 2500m × 40m
See Below Chart	2620×300	42 × (MNM:221 MAX:300)* *For detail, ask airport administrator	RWY grooving: 2500m × 40m

Slope of RWY

RJFR AD 2.13 DECLARED DISTANCES

RWY Designator	TORA (m)	TODA (m)	ASDA (m)	LDA (m)	Remarks
1	2	3	4	5	6
18	2500	2500	2500	2500	Nil
36	2500	2500	2500	2500	Nil

RJFR AD 2.14 APPROACH AND RUNWAY LIGHTING

RWY Designator	APCH LGT type LEN INTST	RTHL Color WBAR	PAPI (VASIS) Angle DIST FM THR MEHT	RTZL LEN	RCLL LEN Spacing Color INTST	REDL LEN Spacing Color INTST	RENL Color WBAR	STWL LEN Color
1	2	3	4	5	6	7	8	9
18	PALS (CAT I) 900m LIH	Green Green	PAPI 3.0°/LEFT 419m 66ft	900m	2,500m 30m Coded color (White/Red) LIH	2,500m 60m Coded color (White/Yellow) LIH	Red	Nil (*2)
36	SALS (*1) 420m LIH	Green -	PAPI 3.0°/LEFT 476m 74ft	-	2,500m 30m Coded color (White/Red) LIH	2,500m 60m Coded color (White/Yellow) LIH	Red	Nil (*2)
Remarks								
10								
SALS with APCH LGT beacon(LEN: 480m)(*1) Overrun area edge LGT(LEN:60m Color: Red)(*2) CGL for RWY 18/36								

RJFR AD 2.15 OTHER LIGHTING, SECONDARY POWER SUPPLY

1	ABN/IBN location, characteristics and hours of operation	ABN: 335039N/1310139E, White/Green EV4.3sec, HO
2	LDI location and LGT Anemometer location and LGT	LDI: Nil Anemometer: 571m FM RWY18 THR/LGTD 247m FM RWY36 THR/LGTD
3	TWY edge and centerline lighting	TWY edge LGT: Blue TWY CL LGT: ALTN Green/Yellow FM RWY leaving Report point, other Green
4	Secondary power supply / switch-over time	Within 1 sec : REDL, RENL, RTHL, WBAR, RCLL, Overrun area edge LGT, Stop bar LGT Within 15 sec : Other LGT
5	Remarks	WDI LGT

RJFR AD 2.16 HELICOPTER LANDING AREA

Nil

RJFR AD 2.17 ATS AIRSPACE

Designation and lateral limits		Vertical limits (ft)	Airspace classification	ATS unit call sign Language	Remarks
1		2	3	4	6
Kitakyushu CTR	Area within a radius of 5nm of Kitakyushu ARP (33° 51'N131° 02'E), excluding the area of TSUIKI CTR.	3000 or below	D	KITAKYUSHU TWR En	

RJFR AD 2.18 ATS COMMUNICATION FACILITIES

Service designation	Call sign	Frequency	Hours of operation	Remarks
1	2	3	4	5
TWR	Kitakyushu Tower	118.85 MHz(1) 126.2MHz 121.5MHz(E) 243.0MHz(E)	2245-1315(*)	(1)Primary
A/G	Kitakyushu Remote	118.85 MHz	1315-2245(*)	Remote air-ground facilities controlled by Fukuoka FSC

*Depending on air traffic situation, ATC service will be provided either from 2230 to 2245 or from 1315 to 1330.

RJFR AD 2.19 RADIO NAVIGATION AND LANDING AIDS

Type of aid (VOR declination)	ID	Frequency	Hours of operation	Position of transmitting antenna coordinates	Elevation of DME transmitting antenna	Remarks
1	2	3	4	5	6	7
VOR (7° W/2019)	SWE	113.85MHz	H24	335123.82N 1310145.84E		VOR Unusable: 230°-250° beyond 30nm BLW 5000ft. 250°-260° beyond 35nm BLW 5000ft. 270°-280° beyond 25nm BLW 5000ft. 280°-310° beyond 30nm BLW 5000ft.
DME	SWE	1046MHz (CH-85Y)	H24	335123.82N 1310145.84E	62.3ft	DME Unusable: 090°-110° beyond 35nm BLW 3000ft. 220°-230° beyond 35nm BLW 5000ft. 230°-240° beyond 30nm BLW 5000ft. 240°-250° beyond 25nm BLW 5000ft. 250°-260° beyond 30nm BLW 5000ft. 260°-270° beyond 35nm BLW 5000ft. 270°-280° beyond 20nm BLW 5000ft. 280°-290° beyond 15nm BLW 5000ft. 290°-300° beyond 20nm BLW 5000ft. 300°-310° beyond 15nm BLW 5000ft.
ILS-LOC 18 (CAT- I)	IKQ	109.15MHz	H24	334956.84N 1310215.91E		BRG(MAG) 177° 235m away FM RWY36 THR
ILS-GP 18		331.25MHz	H24	335115.08N 1310204.71E		GP angle 3.0° HGT of ILS Ref datum 54ft. 315m inside FM RWY18 THR 120m E of RCL
ILS-DME 18	IKQ	1115MHz (CH-28Y)	H24	335115.07N 1310204.91E	45.9ft	315m inside FM RWY18 THR 125m E of RCL
MSAS		1575.42MHz	H24			Transmitting antennas are satellite based

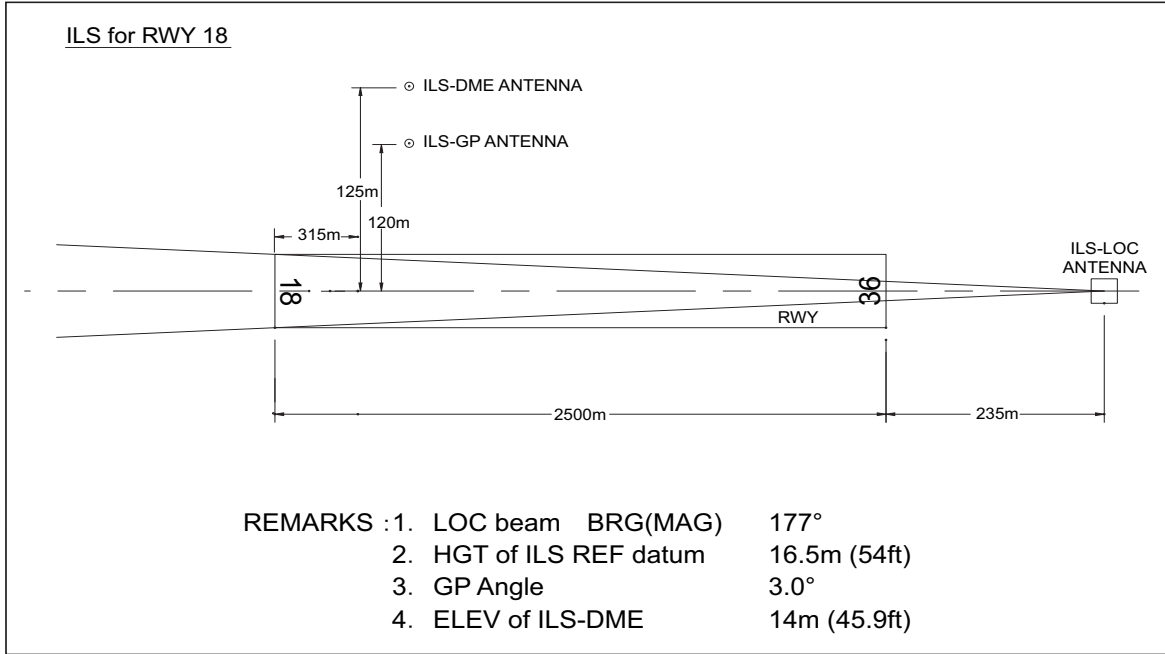

RJFR AD 2.20 LOCAL TRAFFIC REGULATIONS

1. Airport regulations

1.1 Prior notification should be required with AD Administration when using the Airport.

空港を使用する場合は、あらかじめ北九州空港事務所へ調整すること。

1.2 Prior notification should be required with AD Administration for the purpose of getting the permission when crossing Kitakyushu CTR from 1315UTC to 2245UTC.

For further information (0000UTC-0800UTC MON-FRI EXC HOL)

Air Traffic Controller Office, Kitakyushu Airport Office

TEL: 093-475-9086

22時15分から07時45分までの間、北九州管制圏を通過する場合は、当該通過の許可を得るためにあらかじめ北九州空港事務所へ調整すること。

問い合わせ先

北九州空港事務所管制官事務室

(月曜日から金曜日までのうち、9時00分から17時00分までの間。ただし休日を除く。)

TEL: 093-475-9086

2. Special notice to B747-8F operators

B747-8Fに係る運用について

1) Runway

滑走路

B747-8F which land on RWY18/36 should equip and activate Digital Avionics to maintain the precise path during approach. In case of using RWY18/36 by B747-8F, the aircraft with Wing Span 56.4m or larger is not permitted to use TWY P1-P5 simultaneously.

滑走路18/36に着陸するB747-8Fは、正確な進路を維持するためデジタル・アビオニクスを備えかつ作動させること。

B747-8Fが滑走路を使用する場合に、全幅56.4m以上の航空機が誘導路P1-P5を同時使用することを制限する。

2) Taxiways

誘導路

In case of taxiing on TWY P1-P5 by B747-8F, the aircraft with Wing Span 56.4m or larger is not permitted to use runway simultaneously.

B747-8Fが誘導路P1-P5を走行する場合に、全幅56.4m以上の航空機が滑走路を同時使用することを制限する。

3) Parking stand

駐機場

Available aircraft parking stand for B747-8F is NR.0 and NR.90.

駐機可能なスポットは、NR.0及びNR.90である。

2. Taxiing to and from stands

Nil

3. Parking area for small aircraft(General aviation)

Nil

4. Parking area for helicopters

Nil

5. Apron - taxiing during winter conditions

Nil

6. Taxiing - limitations

1. Wing tip clearance at the TWY intersection (REF. AD1.1.6.8)
 誘導路交差点の翼端クリアランス (AD1.1.6.8 参照)

Wing tip clearance at the TWY intersection between the aircraft holding at the stop marking on the TWY and the other aircraft taxiing behind it are as follows.
 誘導路上の停止位置に待機中の航空機と後方の誘導路を走行する航空機の翼端クリアランスは以下のとおりである。

When B744 holding at the stop marking on TWY T2, T3, T4 and T5

Wing Span (WS) of aircraft taxiing on TWY	WS=<6.12m	6.12m<WS=<23.12m	WS>23.12m
Wing tip clearance	*A	*B	*C

Legend:
 *A:wing tip clearance >= 15m
 *B:6.5m =< wing tip clearance < 15m
 *C:wing tip clearance < 6.5m

When B738 holding at the stop marking on TWY T2, T3, T4 and T5

Wing Span (WS) of aircraft taxiing on TWY	WS=<86.12m
Wing tip clearance	*A

When A320 holding at the stop marking on TWY T2, T3, T4 and T5

Wing Span (WS) of aircraft taxiing on TWY	WS=<87.78m
Wing tip clearance	*A

7. School and training flights - technical test flights - use of runways

Nil

8. Helicopter traffic - limitation

Nil

9. Removal of disabled aircraft from runways

Nil

RJFR AD 2.21 NOISE ABATEMENT PROCEDURES

<p>1. 騒音軽減運航方式</p> <p>すべてのジェット機に対して、空港周辺における航空機騒音軽減のため、運航の安全に支障のない範囲で、以下の方式が適用される。</p> <p>(1) 離陸について</p> <p>i) ONGHA DEPARTURE SWE を可能な限り高い高度で通過すること</p> <p>ii) ASARI DEPARTURE(RWY36) 速やかに右旋回を行うこと</p> <p>(2) 着陸について (滑走路 18/36) ディレイド・フラップ進入方式及び低フラップ角着陸方式とする</p> <p>(3) 進入および優先飛行経路について</p> <p>i) 周回進入を行う場合および計器飛行方式を取り下げた場合について</p> <p>a) 空港島の西側および空港北西部の陸域を飛行しないこと (別図参照)</p> <p>b) 場周経路については、可能な限りファイナル・アプローチを短くすること</p> <p>ii) VOR RWY18</p> <p>a) 最終進入経路上において進入灯または滑走路を視認した場合であっても空港北西部の陸域を避けて飛行すること (別図参照)</p> <p>iii) LOC Y RWY18</p> <p>a) 脚下げは海上で行うこと</p> <p>b) ディレイド・フラップ進入方式 1500 フィート通過後、最終フラップ角とすること</p> <p>iv) ILS Z or LOC Z RWY18</p> <p>a) 基礎旋回については騒音軽減のため可能な限り空港北部の住宅地域に配慮した旋回を行うこと</p> <p>b) 2500 フィート通過後、脚下げを行うこと</p> <p>c) ディレイド・フラップ進入方式 1500 フィート通過後、最終フラップ角とすること</p> <p>2. 優先滑走路方式</p> <p>なし</p> <p>3. 優先飛行経路</p> <p>上記、「1 騒音軽減運航方式 (3) 進入および優先飛行経路について」を参照のこと</p> <p>4. リバース・スラスト使用について</p> <p>22 時以降翌朝 6 時までの間、運航の安全に支障のない範囲で、リバース・スラストについてはアイドルまでに制限する。</p>	<p>1. Noise Abatement Operating Procedures (See AIP AD1.1 6.5)</p> <p>For all jet aircraft, in order to reduce aircraft noise in the vicinity of airport, the following procedures shall be applied unless compliance of the procedures adversely affects the safety of aircraft operations.</p> <p>(1) For take-off</p> <p>i) ONGHA DEPARTURE Cross SWE at practically high altitude.</p> <p>ii) ASARI DEPARTURE(RWY36) Commence right turn as soon as practical.</p> <p>(2) For landing(RWY18/36) Execute Delayed Flap Approach Procedure and Reduced Flap Setting Procedure.</p> <p>(3) Approach Procedures and Noise Preferential Routes</p> <p>i) Circling approach and in case of canceling IFR</p> <p>a) Do not fly over the west side of Kitakyushu Airport Island and the land areas located northwest side of the airport (See map).</p> <p>b) In traffic pattern, shorten the final approach course as much as possible (See map).</p> <p>ii) VOR RWY18</p> <p>a) Even if the approach lights and/or the runway are in sight on final approach, do not fly over land areas northwest side of the airport (See map).</p> <p>iii) LOC Y RWY18</p> <p>a) Perform gear down over the sea.</p> <p>b) Delayed Flap Approach Procedure Set final flap after passing 1500feet</p> <p>iv) ILS Z or LOC Z RWY18</p> <p>a) In taking base turn, take notice of reducing the aircraft noise impact on residential areas located north side of the airport.</p> <p>b) Make gear down after passing 2500feet.</p> <p>c) Delayed Flap Approach Procedure Set final flap after passing 1500feet</p> <p>2. Preferential Runways Procedures</p> <p>Nil</p> <p>3. Noise Preferential Routes</p> <p>See upper item 1 Noise Abatement Operating Procedures (3).</p> <p>4. Reverse Thrust</p> <p>Between 1300UTC(2200JST) and 2100UTC(0600JST), the use of reverse thrust is limited to idle except for safety reasons</p>
--	---

5. 計器進入方式の使用について

- (1) 計器進入方式については原則として空港の気象状態により管制機関から指定される。
- (2) 6時から22時まで
 - i) 以下の順位で指定される
 - 第1順位 VOR A または VOR B
 - 第2順位 ILS Z or LOC Z RWY18
 - ii) VOR RWY18 および LOC Y RWY18 については、この時間帯は指定されない
- (3) 22時以降翌朝6時まで

空港の気象状態に加え、空港周辺および空港北部の住宅地域における航空機騒音を軽減するため、以下の順位で指定される

- 第1順位 VOR A または VOR B
- 第2順位 VOR RWY18
- 第3順位 LOC Y RWY18
- 第4順位 ILS Z or LOC Z RWY18

注：RNP AR 進入を行う航空機については、(1)～(3)は適用されない。

5. The use of Instrument Approach Procedures(IAPs)

- (1) In principle, IAPs are assigned by ATC according to the airport weather condition.
- (2) Between 2100UTC(0600JST) and 1300UTC(2200JST)
 - i) According to the airport weather condition, IAPs are assigned in following order.
 - No1. VOR A or VOR B
 - No2. ILS Z or LOC Z RWY18
 - ii) VOR RWY18 and LOC Y RWY18 are not assigned in this time period.

- (3) Between 1300UTC (2200JST) and 2100UTC (0600JST)

In order to avoid aircraft noise impact in the vicinity of airport and residential areas located north side of the airport, IAPs are assigned in following order according to the airport weather condition.

 - No1. VOR A or VOR B
 - No2. VOR RWY18
 - No3. LOC Y RWY18
 - No4. ILS Z or LOC Z RWY18

NOTE: (1)-(3) are not applicable to RNP AR approach.

Noise Abatement Operating Procedures

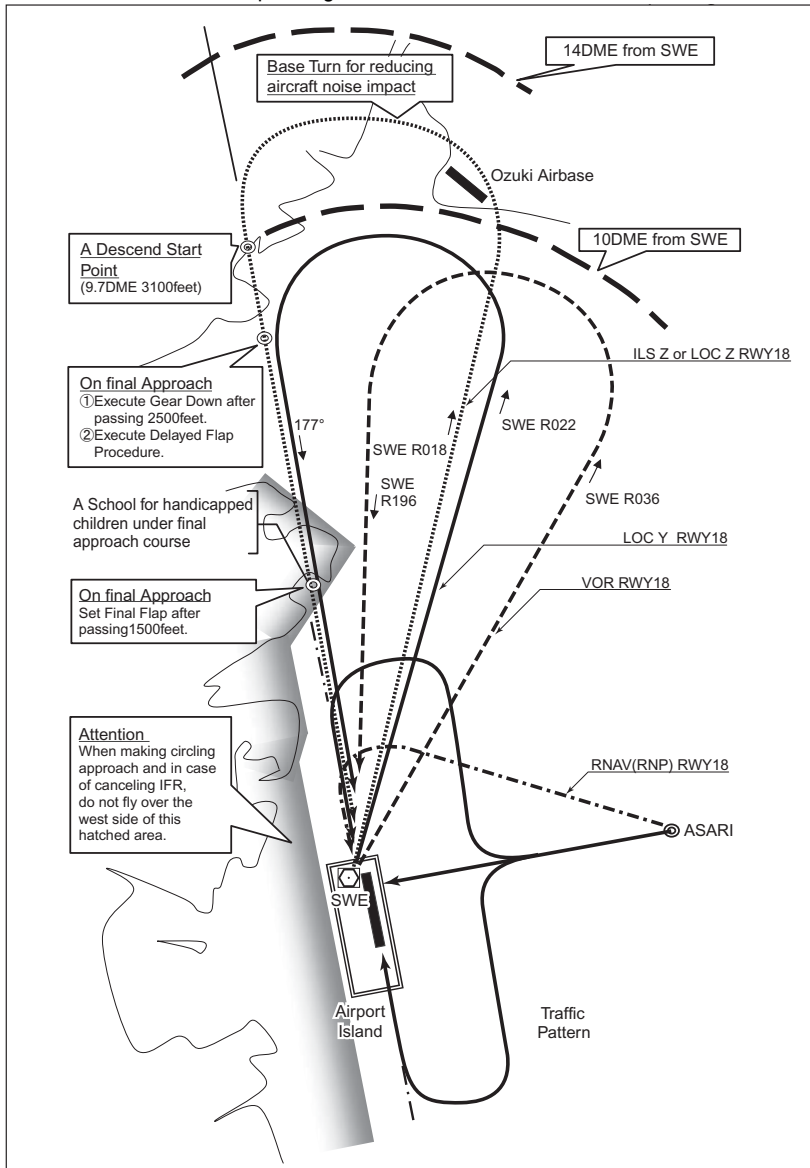

RJFR AD 2.22 FLIGHT PROCEDURES

1. TAKE OFF MINIMA

	RWY	ACFT CAT	REDL & RCLL		REDL or RCLL or RCL marking		NIL (DAYTIME ONLY)	
			RVR	VIS	RVR	VIS	RVR	VIS
Multi-Engine ACFT with TKOF ALTN AP FILED	18	A,B,C,D	400m	400m	400m	400m	-	500m
	36	A,B,C,D	-	400m	-	400m	-	500m
OTHER	18	A,B,C,D	AVBL LDG MINIMA					
	36							

2. Lost communication procedures for arrival aircraft under radar navigational guidance

If radio communications with TSUIKI Radar are lost for 1 minute, squawk Mode A/3 Code 7600 and ;

- (I) 1. Contact Kitakyushu Tower / Kitakyushu Remote.
- 2. If unable, proceed in accordance with Visual Flight Rules.
- 3. If unable, proceed to SWE VOR last assigned altitude or 5,000 feet whichever is higher, and execute VOR B approach.
- (II) Procedures other than above will be issued when situation required.

3. Automated Radar Terminal System(ARTS)

Aircraft flying under control of TSUIKI approach control in the approach control area will be instructed to reply with discrete code on Mode A/3 and Mode C.

If an aircraft with non-discrete code capability is instructed to reply with the discrete code, it shall report a controller accordingly.

築城ターミナル管制所の指示のもとに、当該進入管制区を飛行する航空機は、モード A/3 の二次レーダー個別コード及びモード C による応答を指示される。

二次レーダー個別コードを搭載していない航空機が当該コードによる応答を指示された場合は、管制官に対し、その旨通報すること。

4. Use of Instrument Approach Procedure (IAP)

Between 0600JST (2100UTC) and 2200JST (1300UTC), in principle ILS Z or LOC Z RWY 18 would be applied only when weather condition is below WX MINIMA of VOR A and VOR B.

計器進入方式の使用

6 : 00 ~ 22 : 00 の間、北九州空港の気象状態が VOR A 及び VOR B 進入方式の着陸の最低気象条件未満である場合を除き、原則として ILS Z or LOC Z RWY18 進入方式は許可されない。

5. Use of Simulated Instrument Approach

Simulated approach would not be applied other than VOR A and VOR B.

模擬計器進入

北九州空港における模擬計器進入は VOR A 及び VOR B 進入方式以外は許可されない。

RJFR AD 2.23 ADDITIONAL INFORMATION

1. Vessel will be pass in the vicinity of the airport. (See LDG CHART)
 空港周辺を船舶が通過する。(See LDG CHART)

2. Helicopter Landing Area

Location:

North HELIPAD: On the intersection of PARL TWY and TWY T3

South HELIPAD: On PARL TWY P5

Lighting: Nil

(See AD CHART)

位置:

ノースヘリパッド: 平行誘導路と誘導路 T3 の交差点

サウスヘリパッド: 平行誘導路 P5 上

灯火: 無し

(See AD CHART)

RJFR AD 2.24 CHARTS RELATED TO AN AERODROME

Aerodrome/Heliport Chart
 Standard Departure Chart - Instrument (ASARI)
 Standard Departure Chart - Instrument (ONGHA)
 Standard Departure Chart - Instrument (KOHEI-RNAV)
 Instrument Approach Chart (ILS Z or LOC Z RWY18)*
 Instrument Approach Chart (LOC Y RWY18)*
 Instrument Approach Chart (VOR RWY18)*
 Instrument Approach Chart (VOR A)*
 Instrument Approach Chart (VOR B)*
 Instrument Approach Chart (RNAV(RNP) RWY18)
 Instrument Approach Chart (RNAV(RNP) RWY36)
 Other Chart (Visual REP)
 Other Chart (LDG CHART)
 Other Chart (MVA CHART)

*: Designed in accordance with provisional standards for FLIGHT PROCEDURE DESIGN.

RJFR / KITAKYUSHU

Visual REP

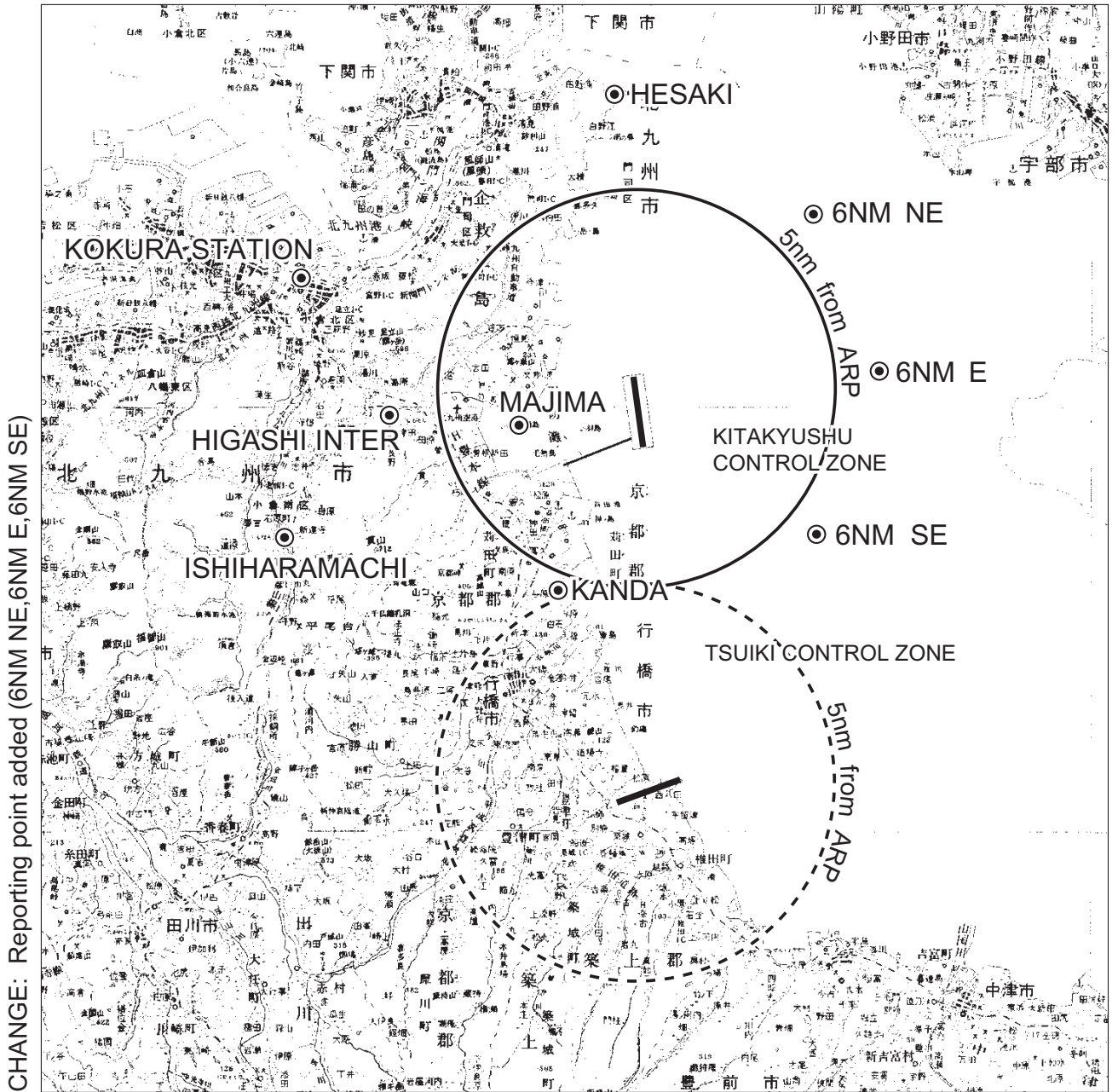

RJFR / KITAKYUSHU

Visual REP

Call sign	BRG / DIST from ARP	Remarks
部 崎 Hesaki	355°/6.8NM	灯台 Lighthouse
6NM NE	045°/6.0NM	海上 Over the sea
6NM E	090°/6.0NM	海上 Over the sea
6NM SE	135°/6.0NM	海上 Over the sea
苅 田 Kanda	202°/5.5NM	日産自動車工場 Automobile manufacturing plant
石 原 町 Ishiharamachi	247°/9.2NM	JR石原町駅 Station
間 島 Majima	252°/3.1NM	島 Island
東インター Higashi Inter	263°/6.2NM	小倉東I.C.(九州自動車道) Interchange
小倉ステーション Kokura Station	288°/8.0NM	JR小倉駅 Station

CHANGE: Reporting point added (6NM NE,6NM E,6NM SE)

RJFR / KITAKYUSHU

LDG CHART

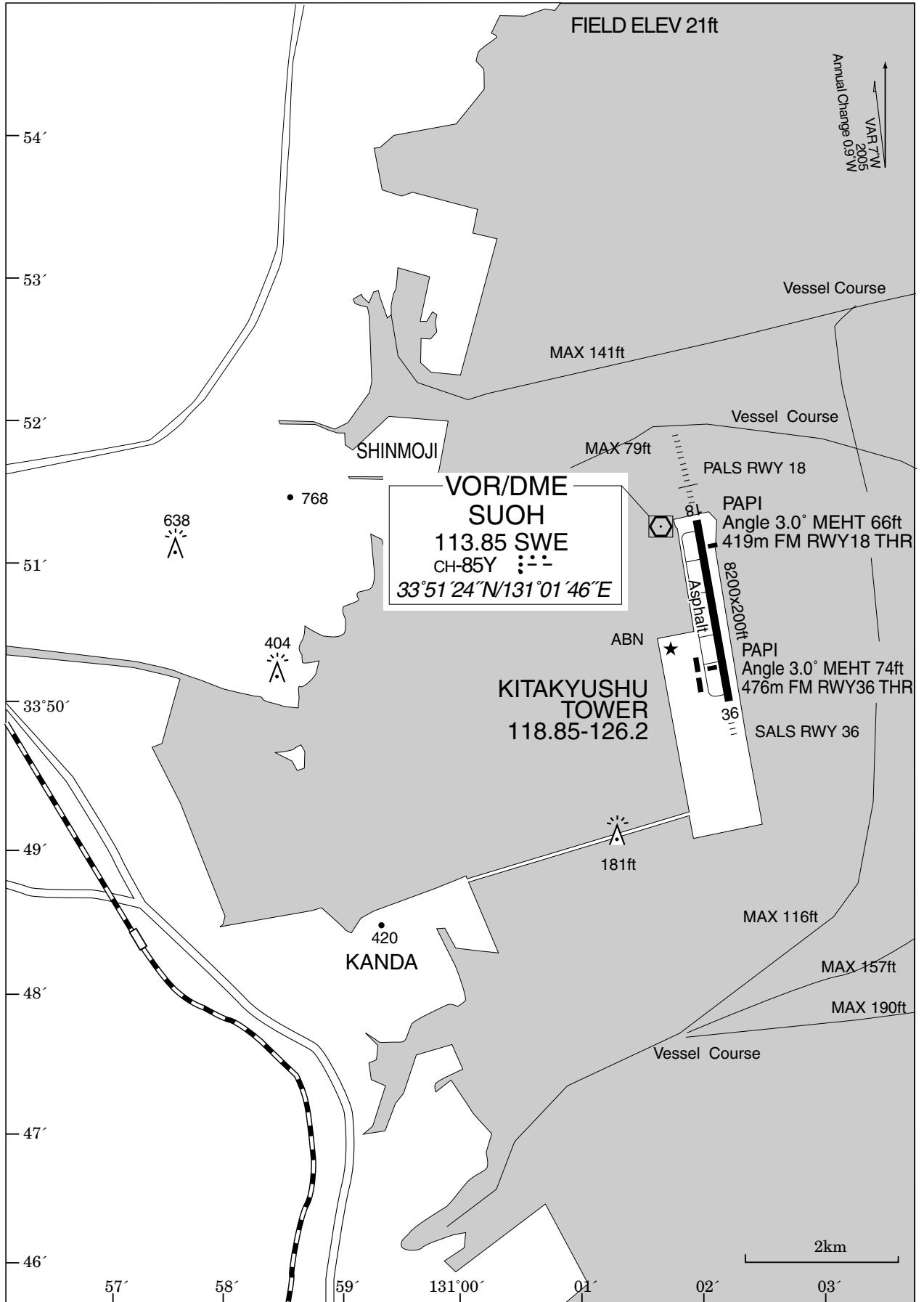

STANDARD DEPARTURE CHART-INSTRUMENT

RJFR / KITAKYUSHU RNAV SID and TRANSITION

KOHEI ONE DEPARTURE DOUGO TRANSITION	RNAV1
<p>Note 1) DME/DME/IRU or GNSS required. ※ The aircraft equipped with only DME/DME/IRU must be able to update its position without delay at the starting point of take-off roll. 2) RADAR service required.</p>	<p>RWY18 : SWE : 2.0NM from DER - 12.0NM to KOHEI UBE : 16.0NM to KOHEI - KOHEI RWY36 : UBE : 12.0NM to KOHEI - KOHEI</p>
Critical DME	
DME GAP	<p>RWY18 : DER - 2.0NM from DER RWY36 : DER - 12.0NM to KOHEI</p>
Inappropriate NavAids	<p>See AD1.1.6.10.3. Inappropriate NAVAIDs for RNAV1</p>

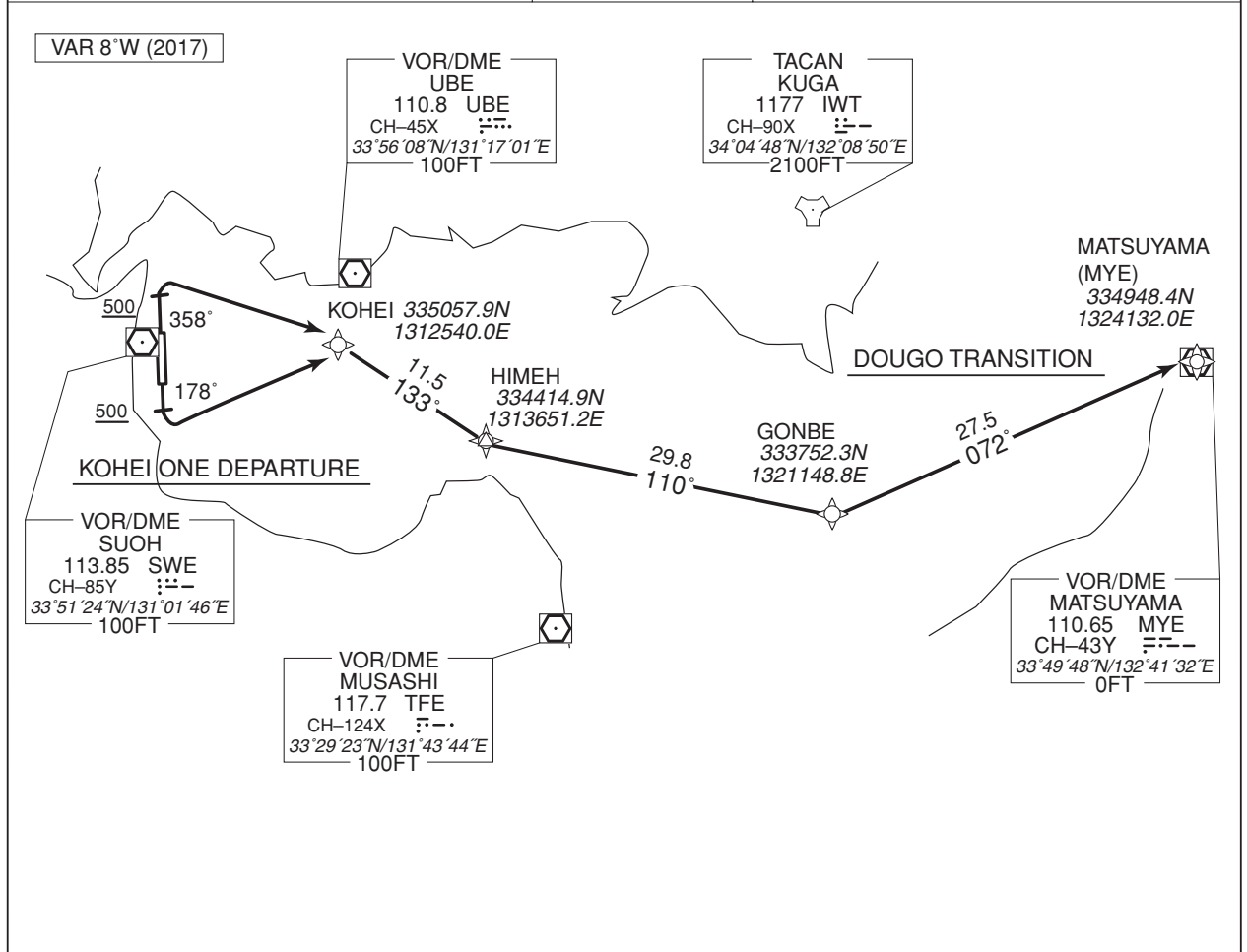

KOHEI ONE DEPARTURE
 RWY18 : Climb on HDG178° at or above 500FT, turn left direct to KOHEI.
 RWY36 : Climb on HDG358° at or above 500FT, turn right direct to KOHEI.

Note RWY18: 5.8% climb gradient required up to 500FT due to airspace restrictions only.
 RWY36: 4.0% climb gradient required up to 500FT due to airspace restrictions only.

DOUGO TRANSITION
 From KOHEI, to HIMEH, to GONBE, to MYE.

STANDARD DEPARTURE CHART-INSTRUMENT

RJFR / KITAKYUSHU

RNAV SID and TRANSITION

KOHEI ONE DEPARTURE

RWY18

Serial Number	Path Descriptor	Waypoint Identifier	Fly Over	Course °M(°T)	Magnetic Variation	Distance (NM)	Turn Direction	Altitude (FT)	Speed (KIAS)	Vertical Angle	Navigation Specification
001	VA	—	—	178 (170.4)	-7.5	—	—	+500	—	—	RNAV1
002	DF	KOHEI	—	—	-7.5	—	L	—	—	—	RNAV1

RWY36

Serial Number	Path Descriptor	Waypoint Identifier	Fly Over	Course °M(°T)	Magnetic Variation	Distance (NM)	Turn Direction	Altitude (FT)	Speed (KIAS)	Vertical Angle	Navigation Specification
001	VA	—	—	358 (350.4)	-7.5	—	—	+500	—	—	RNAV1
002	DF	KOHEI	—	—	-7.5	—	R	—	—	—	RNAV1

DOUGO TRANSITION

Serial Number	Path Descriptor	Waypoint Identifier	Fly Over	Course °M(°T)	Magnetic Variation	Distance (NM)	Turn Direction	Altitude (FT)	Speed (KIAS)	Vertical Angle	Navigation Specification
001	IF	KOHEI	—	—	-7.5	—	—	—	—	—	RNAV1
002	TF	HIMEH	—	133 (125.8)	-7.5	11.5	—	—	—	—	RNAV1
003	TF	GONBE	—	110 (102.2)	-7.5	29.8	—	—	—	—	RNAV1
004	TF	MYE	—	072 (064.1)	-7.5	27.5	—	—	—	—	RNAV1

STANDARD DEPARTURE CHART-INSTRUMENT

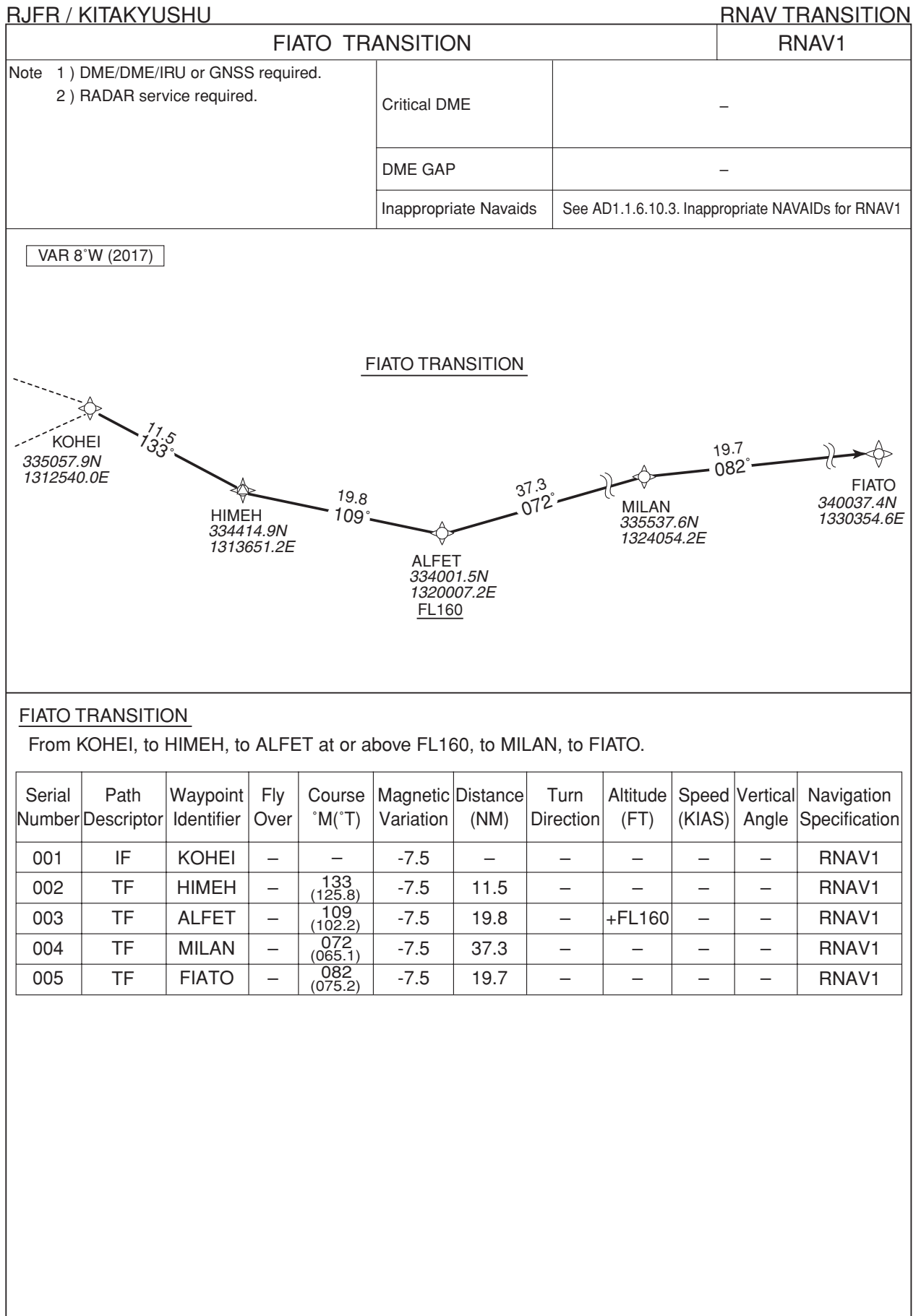

INSTRUMENT APPROACH CHART

RJFR / KITAKYUSHU

RNAV(RNP) RWY18

TSUIKI APP 119.225 – 315.9	GNSS and RF required.	KITAKYUSHU TOWER (1315 – 2245(UTC) KITAKYUSHU REMOTE 118.85 - 126.2 118.85	RADAR AVBL CALL TSUIKI APP
-------------------------------	-----------------------	---	----------------------------------

For uncompensated Baro-VNAV systems, procedure not authorized below -5°C / above 45°C

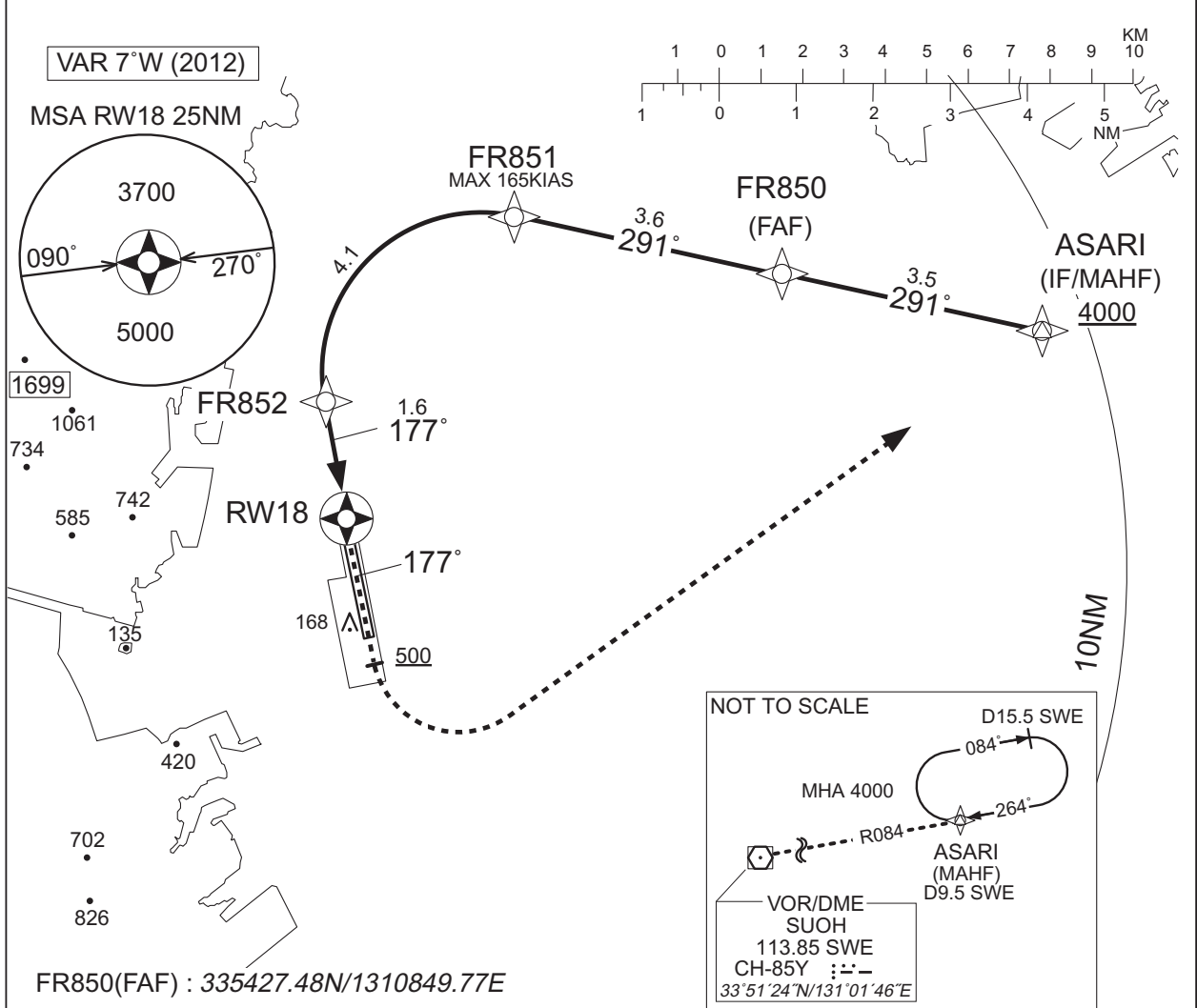

MISSED APPROACH

From RW18 on track 177°, at or above 500FT turn left, direct to ASARI and hold at 4000FT.

Contact TSUIKI APP.

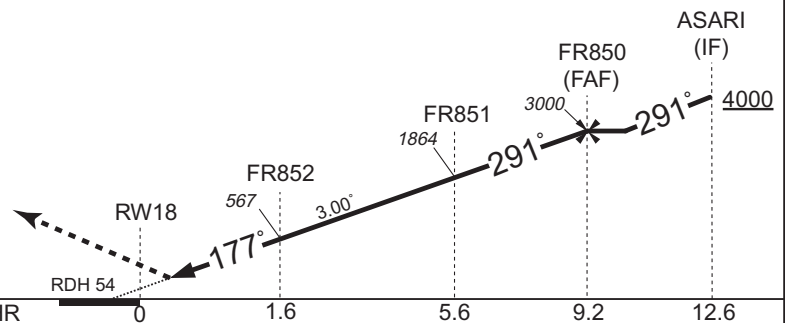

MINIMA		THR elev. 22	AD elev. 21
CAT		RNP 0.30	
	DA(H)	RVR/CMV	
A	-	-	
B	-	-	
C	322(300)	1000	
D		1400	

RNP AR
Special Authorization Required

*Missed APCH climb gradient MNM 5.0%

INSTRUMENT APPROACH CHART

RJFR / KITAKYUSHU

RNAV(RNP) RWY18

RNAV(RNP) RWY18

Coding Table

Serial Number	Path Descriptor	Waypoint Identifier	Fly Over	Course °M(°T)	Magnetic Variation	Distance (NM)	Turn Direction	Altitude (FT)	Speed (KIAS)	VPA/RDH (°/FT)	RNP Value
001	IF	ASARI	—	—	-7.1	—	—	+4000	—	—	—
002	TF	FR850	—	291 (283.6)	-7.1	3.5	—	3000	—	—	1.0
003	TF	FR851	—	291 (283.5)	-7.1	3.6	—	1864	-165	-3.00	0.3
004	RF Center: FRRF1 r=2.06NM	FR852	—	—	-7.1	4.1	L	567	—	-3.00	0.3
005	TF	RW18	Y	177 (170.4)	-7.1	1.6	—	76	—	-3.00/54	0.3
006	FA	—	—	177 (170.4)	-7.1	—	—	+500	—	—	1.0
007	DF	ASARI	—	—	-7.1	—	L	4000	—	—	1.0

Waypoint Coordinates

Waypoint Identifier	Coordinates	RF Arc Center Identifier	Coordinates
ASARI	335338.98N / 1311252.32E	FRRF1	335316.61N / 1310405.62E
FR850	335427.48N / 1310849.77E		
FR851	335517.24N / 1310440.15E		
FR852	335255.76N / 1310139.03E		
RW18	335123.92N / 1310157.83E		

INSTRUMENT APPROACH CHART

RJFR / KITAKYUSHU

RNAV(RNP) RWY36

TSUIKI APP 119.225 – 315.9	GNSS and RF required.	KITAKYUSHU TOWER (1315 – 2245(UTC) KITAKYUSHU REMOTE 118.85 - 126.2 118.85	RADAR AVBL CALL TSUIKI APP
-------------------------------	-----------------------	---	----------------------------------

For uncompensated Baro-VNAV systems, procedure not authorized below -5°C / above 45°C

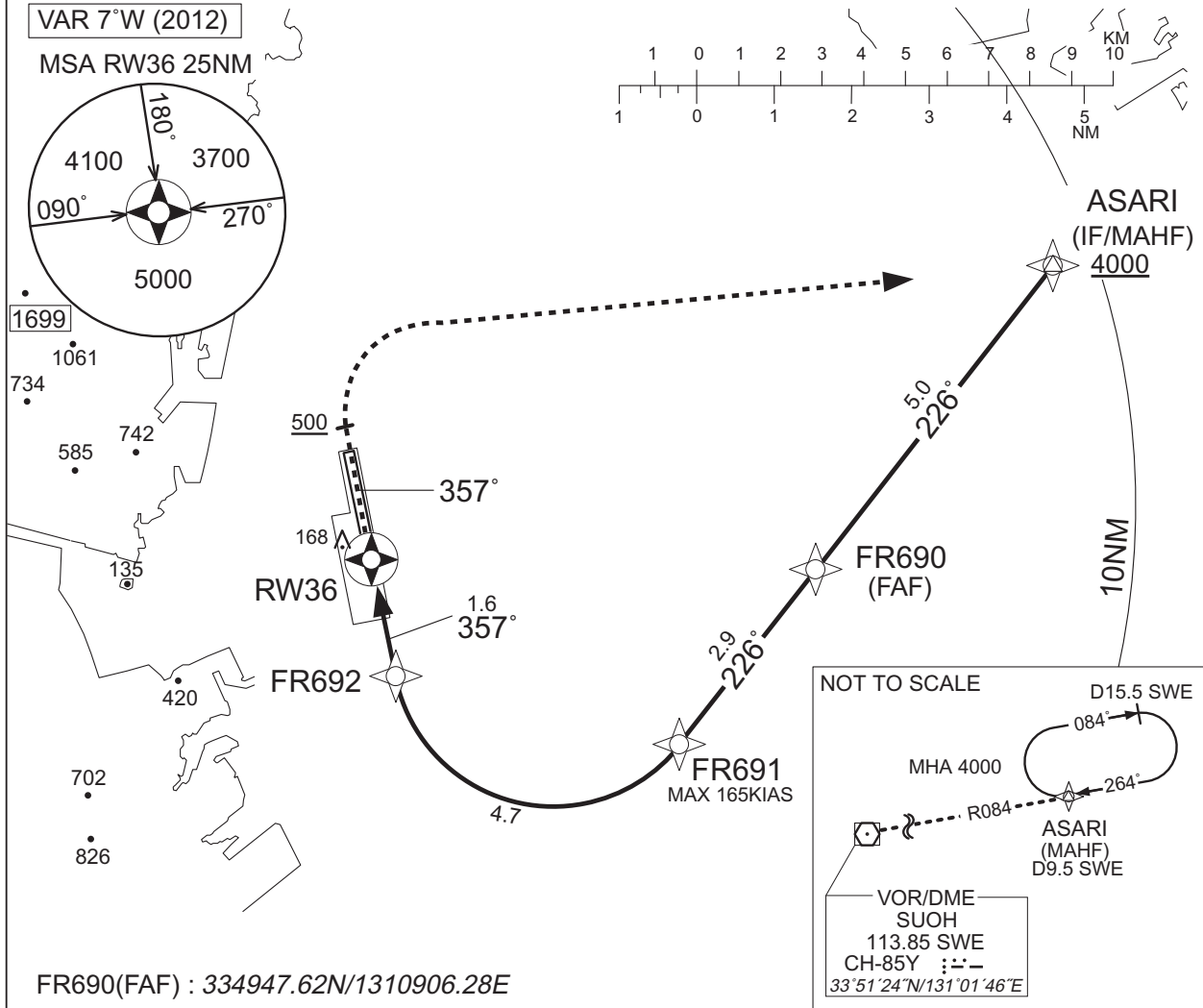

FR690(FAF) : 334947.62N/1310906.28E

MISSED APPROACH

From RW36 on track 357°, at or above 500FT turn right, direct to ASARI and hold at 4000FT.

Contact TSUIKI APP.

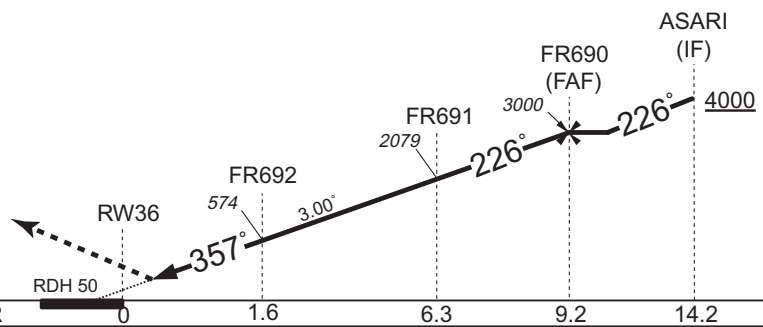

MINIMA		THR elev. 23	AD elev. 21
RNP 0.30			
CAT	DA(H)	CMV	
A	-	-	
B	-	-	
C	329(306)	1400	
D		1600	

RNP AR
Special Authorization Required

*Missed APCH climb gradient MNM 5.0%

INSTRUMENT APPROACH CHART

RJFR / KITAKYUSHU

RNAV(RNP) RWY36

RNAV(RNP) RWY36

Coding Table

Serial Number	Path Descriptor	Waypoint Identifier	Fly Over	Course °M(°T)	Magnetic Variation	Distance (NM)	Turn Direction	Altitude (FT)	Speed (KIAS)	VPA/RDH (°/FT)	RNP Value
001	IF	ASARI	—	—	-7.1	—	—	+4000	—	—	—
002	TF	FR690	—	226 (219.1)	-7.1	5.0	—	3000	—	—	1.0
003	TF	FR691	—	226 (219.0)	-7.1	2.9	—	2079	-165	-3.00	0.3
004	RF Center: FRRF2 r=2.06NM	FR692	—	—	-7.1	4.7	R	574	—	-3.00	0.3
005	TF	RW36	Y	357 (350.4)	-7.1	1.6	—	73	—	-3.00/50	0.3
006	FA	—	—	357 (350.4)	-7.1	—	—	+500	—	—	1.0
007	DF	ASARI	—	—	-7.1	—	R	4000	—	—	1.0

Waypoint Coordinates

Waypoint Identifier	Coordinates	RF Arc Center Identifier	Coordinates
ASARI	335338.98N / 1311252.32E	FRRF2	334851.32N / 1310459.78E
FR690	334947.62N / 1310906.28E		
FR691	334733.05N / 1310655.02E		
FR692	334830.46N / 1310233.32E		
RW36	335004.08N / 1310214.17E		

RJFR / KITAKYUSHU

Minimum Vectoring Altitude CHART

VAR 7°W (2004)

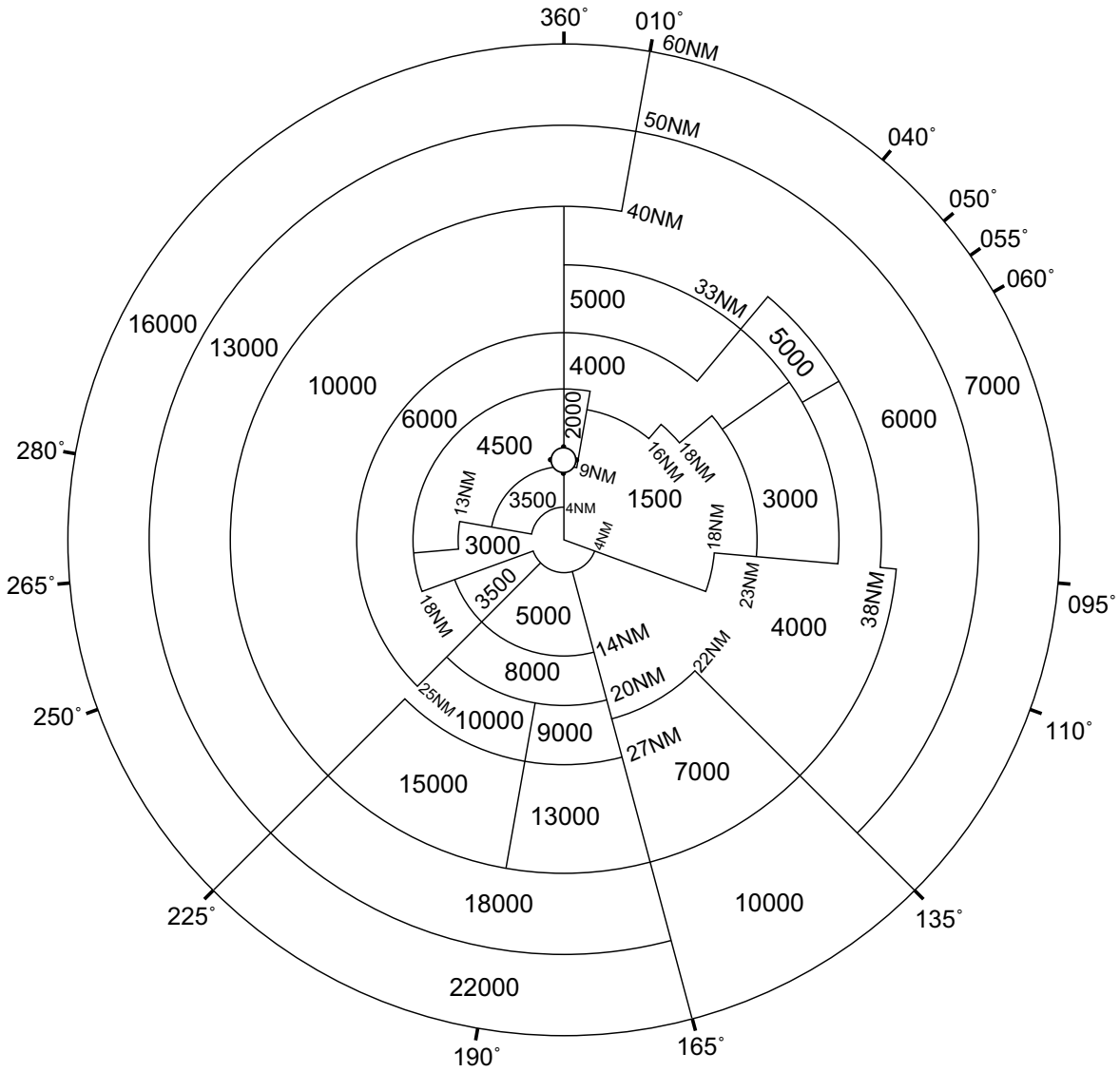

CENTER : 334041N/1310204E (RJFZ RADAR SITE)

STANDARD DEPARTURE CHART - INSTRUMENT

RJFR / KITAKYUSHU

SID

ASARI THREE DEPARTURE

RWY 18 : Climb RWY HDG to 500FT, turn left HDG039°,...

RWY 36 : Climb RWY HDG to 500FT, turn right HDG129°, ...

...to intercept and proceed via SWE R084 to ASARI.

Cross SWE 8.0DME at or above 3000FT.

Note RWY18 : 5.8% climb gradient required up to 500FT due to airspace restrictions only.

RWY36 : 4.0% climb gradient required up to 500FT due to airspace restrictions only.

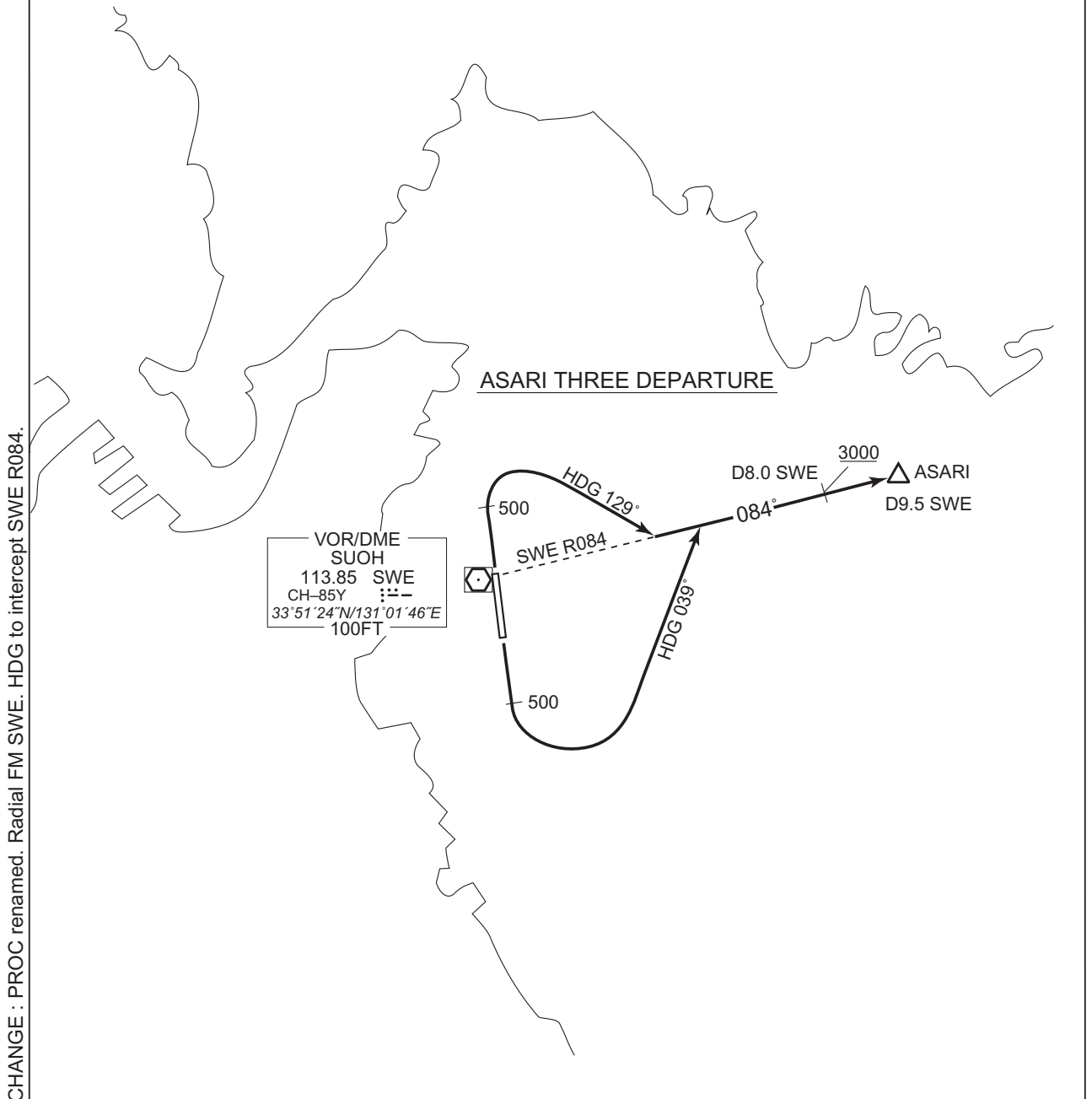

STANDARD DEPARTURE CHART - INSTRUMENT

RJFR / KITAKYUSHU

TRANSITION

MATSUYAMA TRANSITION

From over ASARI, via SWE R084 to intercept and proceed via UBE R133 to HIMEH, via UBE R133 to intercept and proceed via MYE R257 to MYE VOR/DME.

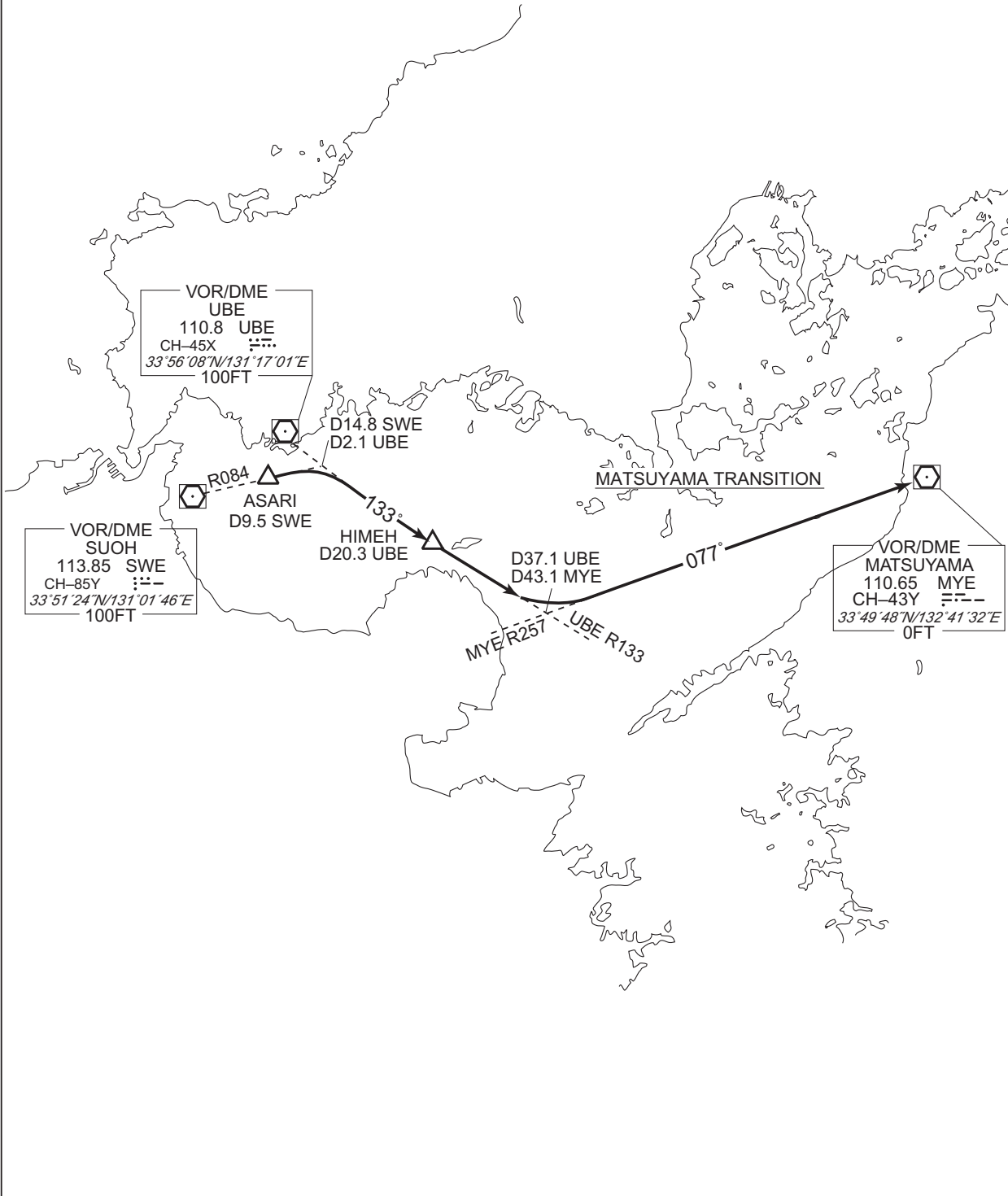

CHANGE : Radial FM SWE.

STANDARD DEPARTURE CHART - INSTRUMENT

RJFR / KITAKYUSHU

TRANSITION

MUSASHI TRANSITION

From over ASARI, via SWE R084 to intercept and proceed via UBE R133 to HIMEH, via TFE R346 to TFE VOR/DME.

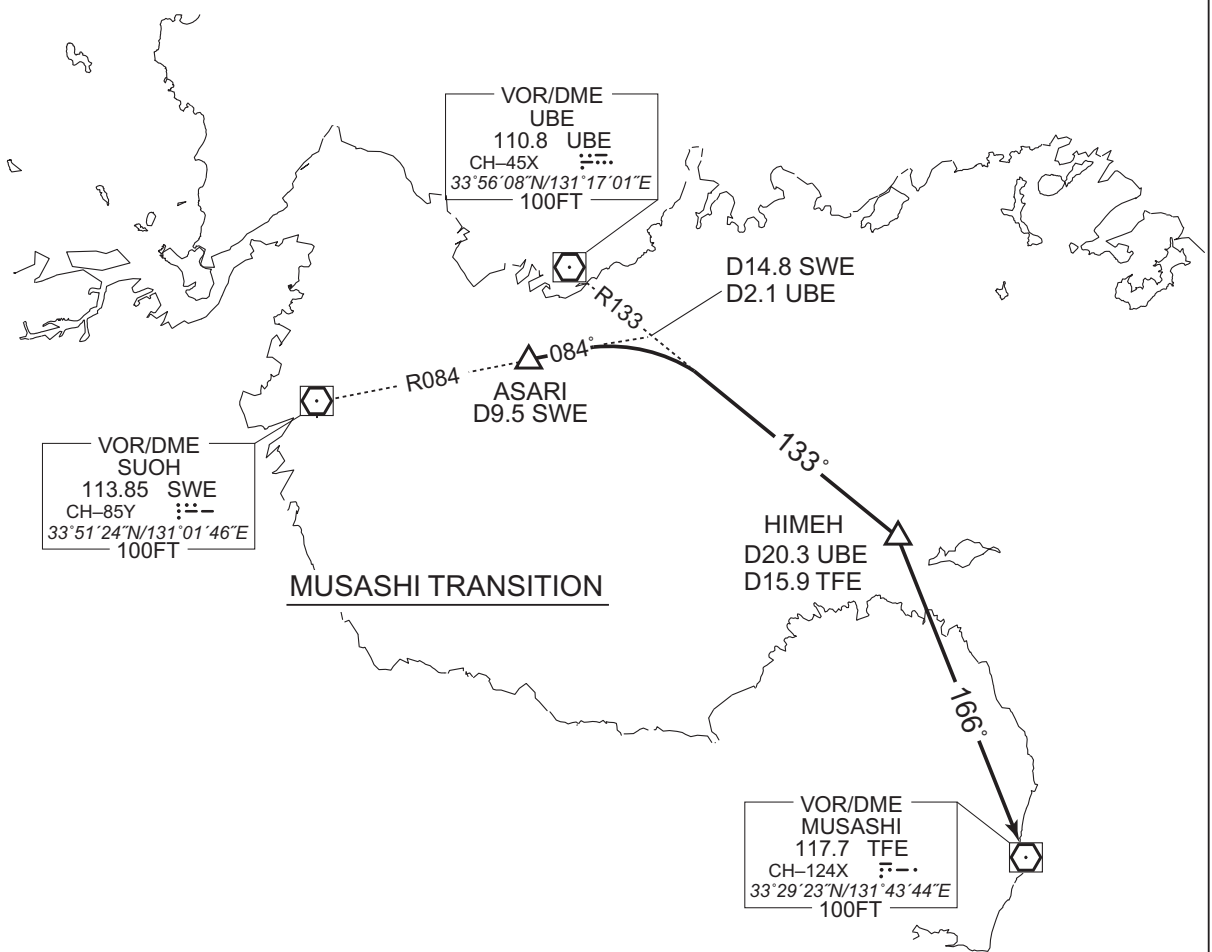

CHANGE : Radial FM SWE.

STANDARD DEPARTURE CHART - INSTRUMENT

RJFR / KITAKYUSHU

SID

ONGHA TWO DEPARTURE

RWY 18 : Climb RWY HDG to 500FT, turn left,...

RWY 36 : Climb RWY HDG to 500FT, turn right,...

...direct to SWE VOR/DME, proceed via SWE R259 to ONGHA.

Cross SWE VOR/DME at or above 3000FT.

Note RWY18 : 5.8% climb gradient required up to 500FT due to airspace restrictions only.

RWY36 : 4.0% climb gradient required up to 500FT due to airspace restrictions only.

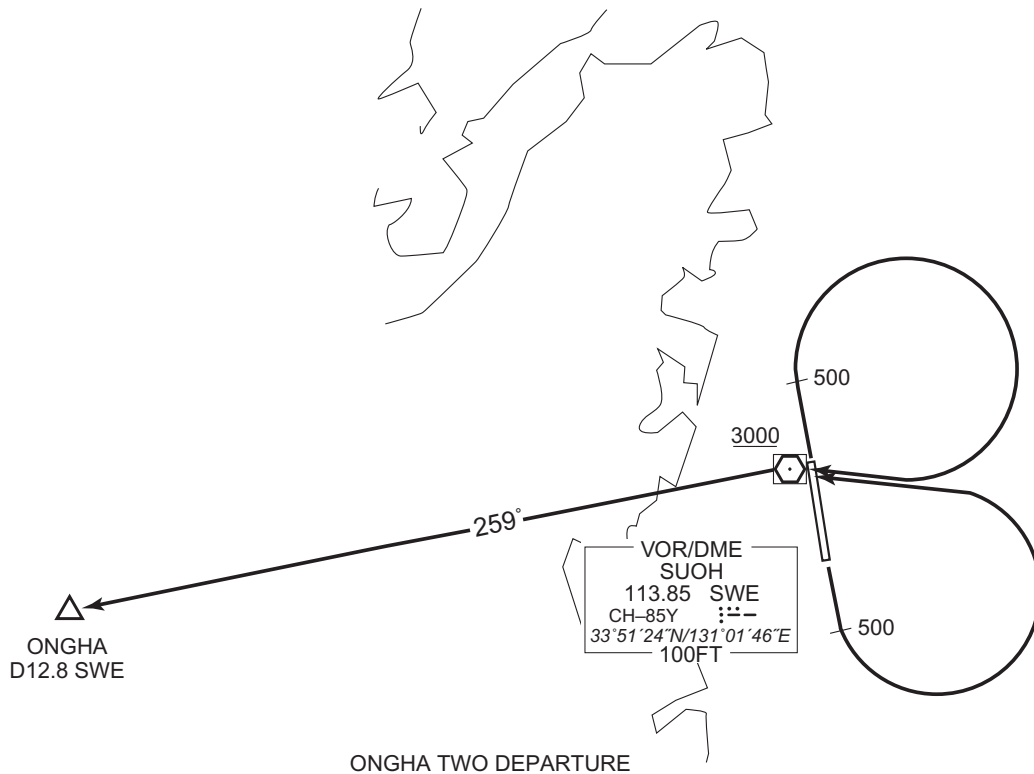

CHANGE : PROC renamed. Radial FM SWE.

INSTRUMENT APPROACH CHART

RJFR / KITAKYUSHU

ILS Z or LOC Z RWY 18

TSUIKI APP 119.225 – 315.9	ILS – LOC 109.15 IKQ 018° ILS-GP 331.25 ILS-DME CH-28Y	KITAKYUSHU TOWER (1315 – 2245(UTC)) KITAKYUSHU REMOTE 118.85	RADAR AVBL CALL TSUIKI APP
-------------------------------	---	--	----------------------------------

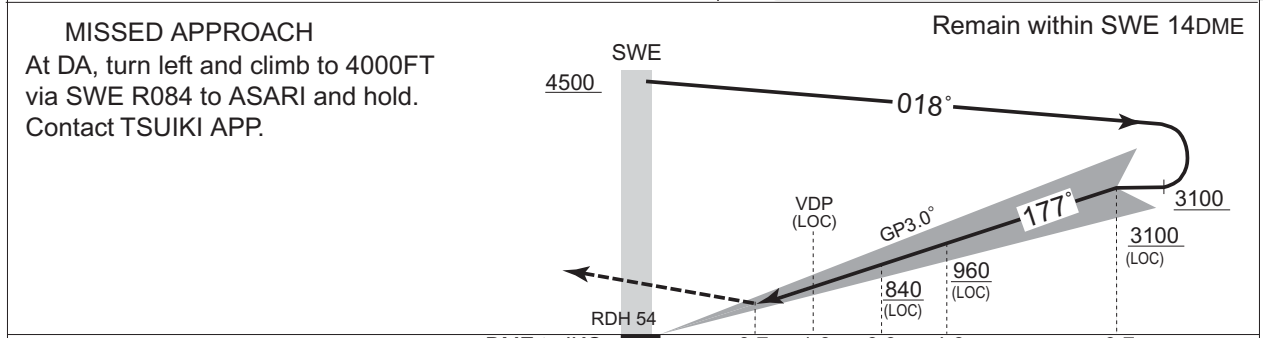
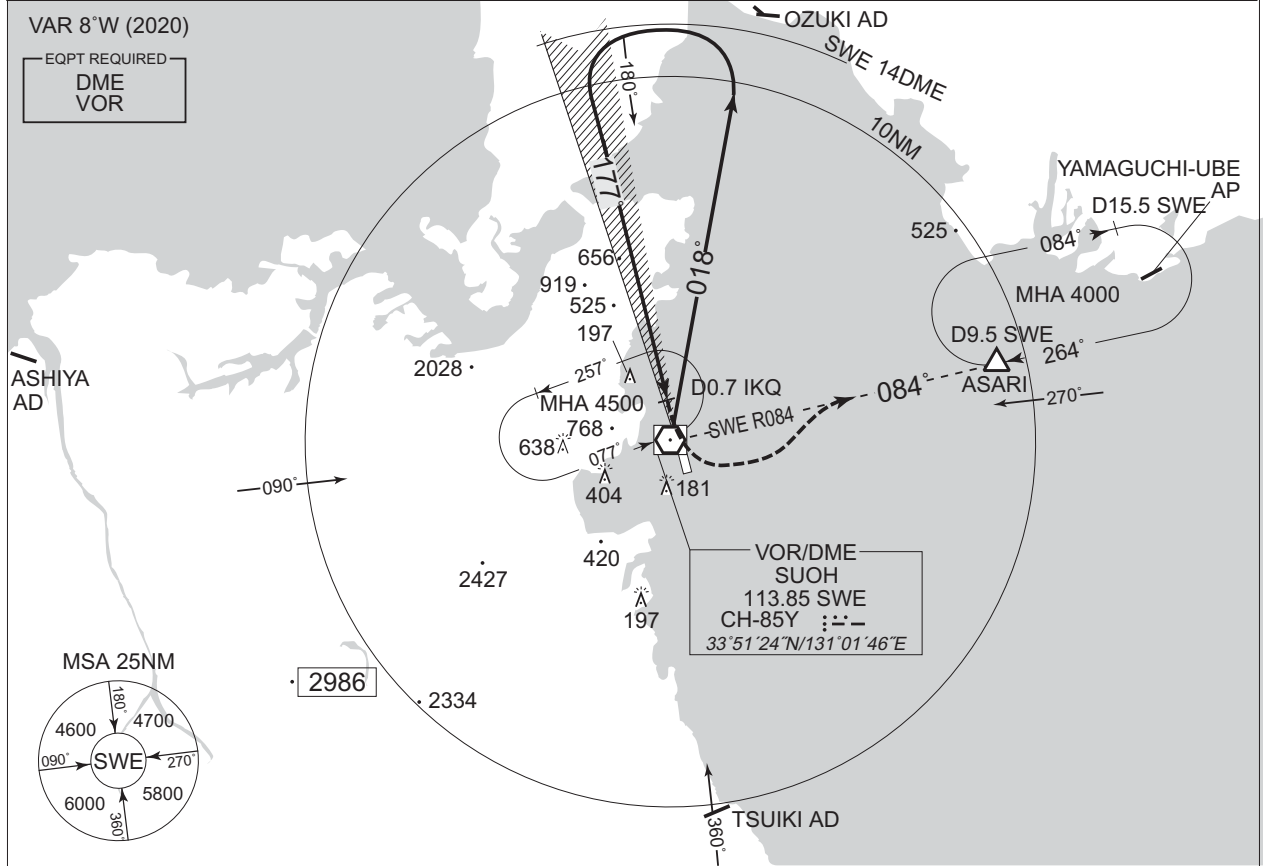

At DA, turn left and climb to 4000FT via SWE R084 to ASARI and hold. Contact TSUIKI APP.

MINIMA		THR elev. 22		AD elev. 21		
CAT	CAT I		LOC		CIRCLING	
	DA(H)	RVR/CMV	MDA(H)	RVR/CMV	MDA(H) VIS	
A	222 (200)	550	500 (479)	1000	500 (479)	1600
B				1200		
C				1600	580 (559)	3200
D						

Circling to East side of RWY only.

CHANGE: GP angle added.

INSTRUMENT APPROACH CHART

RJFR / KITAKYUSHU

LOC Y RWY 18

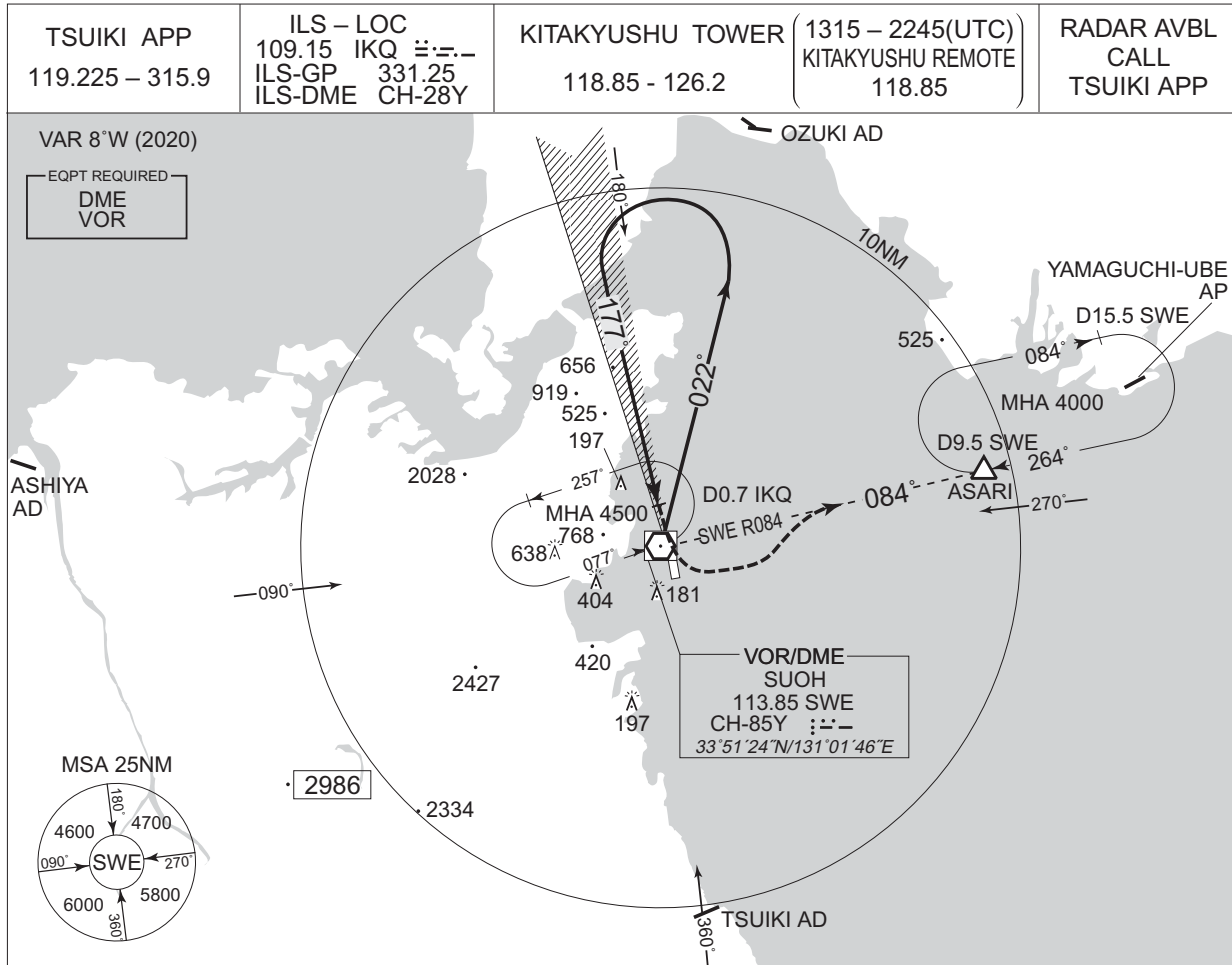

CHANGE : PROC renamed. VAR. MSA. Radial FM SWE.

MISSED APPROACH
At IKQ 0.7DME, turn left and climb to 4000FT via SWE R084 to ASARI and hold.
Contact TSUIKI APP.

Remain within SWE 10DME

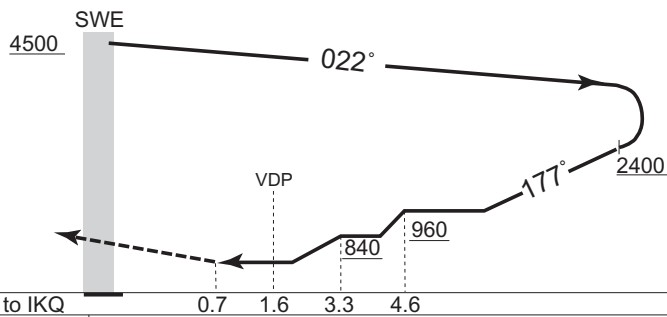

MINIMA		THR elev. 22	AD elev. 21	
CAT	MDA(H)	RVR/CMV	CIRCLING	
			MDA(H)	VIS
A	500 (479)	1000	500 (479)	1600
B		1200		2400
C		1600	580 (559)	3200
D				

Circling to East side of RWY only.

INSTRUMENT APPROACH CHART

RJFR / KITAKYUSHU

VOR RWY 18

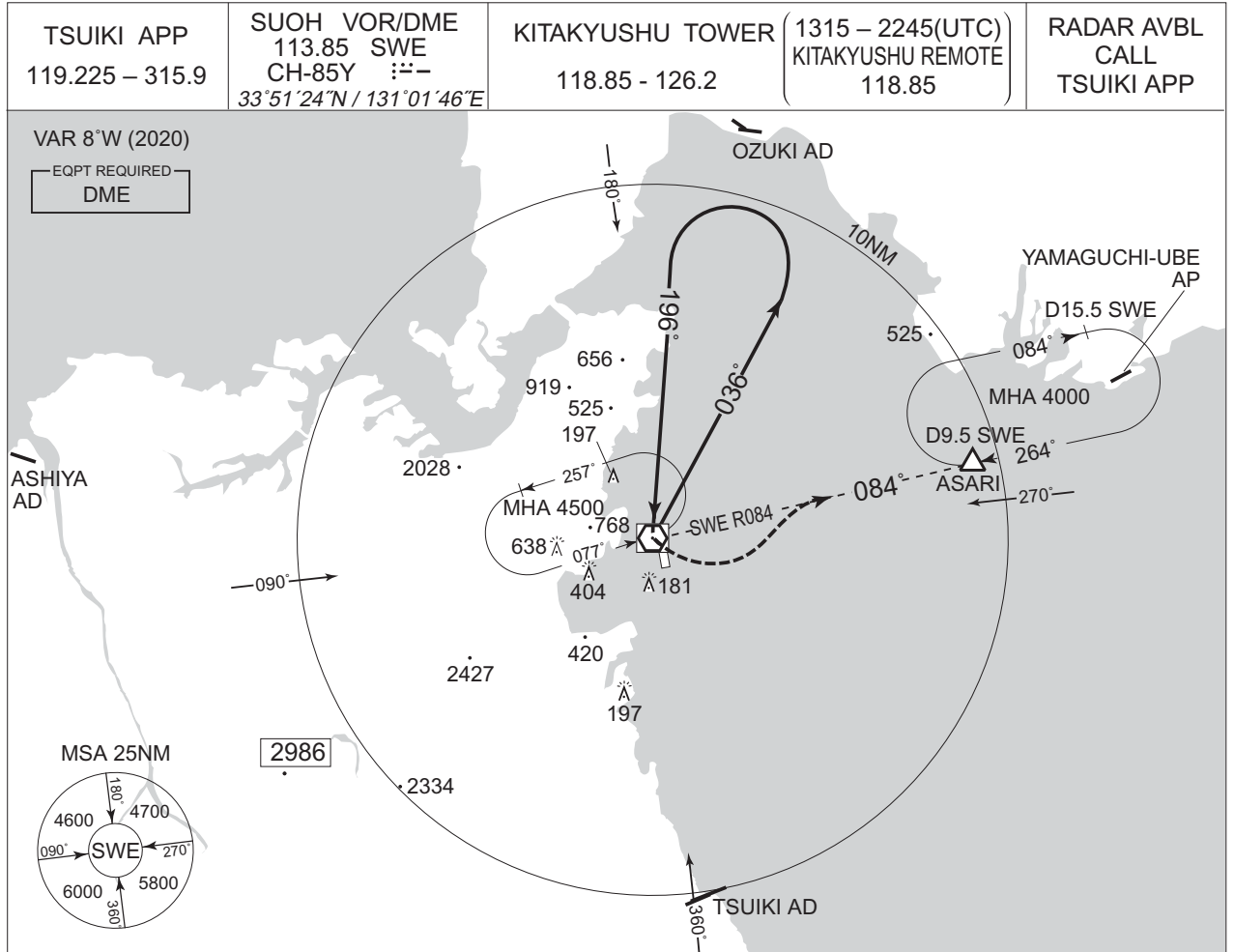

CHANGE : PROC renamed. VAR. MSA. Radial FM SWE.

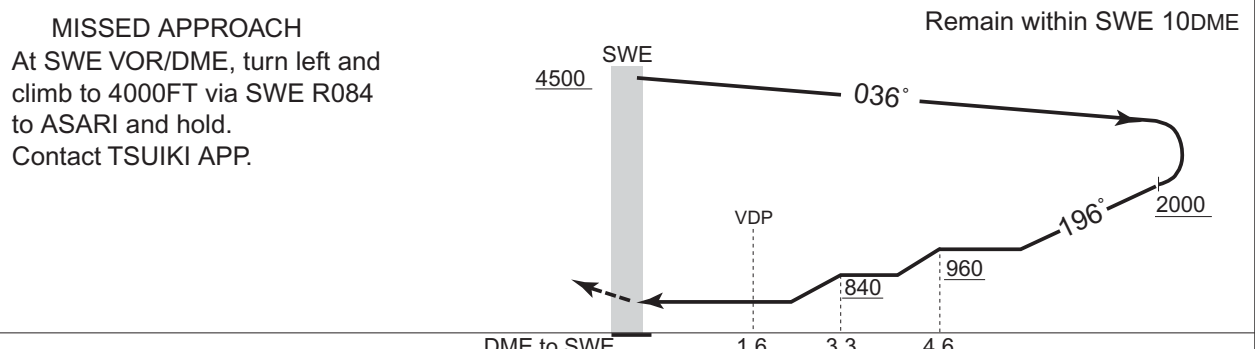

MINIMA		THR elev. 22	AD elev. 21		
CAT			CIRCLING		
	MDA(H)	RVR/CMV	MDA(H)	VIS	
A	500 (479)	1000	500 (479)	1600	
B		1200		580 (559)	2400
C					1600
D					

Circling to East side of RWY only.

INSTRUMENT APPROACH CHART

RJFR / KITAKYUSHU

VOR A

TSUIKI APP 119.225 – 315.9	SUOH VOR/DME 113.85 SWE CH-85Y $\text{---}\text{---}$ 33°51'24"N / 131°01'46"E	KITAKYUSHU TOWER (1315 – 2245(UTC)) KITAKYUSHU REMOTE 118.85	RADAR AVBL CALL TSUIKI APP
-------------------------------	---	--	----------------------------------



MISSED APPROACH
At 1.0DME prior to SWE VOR/DME,
turn left and climb to 4000FT via
SWE R084 to ASARI and hold.
Contact TSUIKI APP.

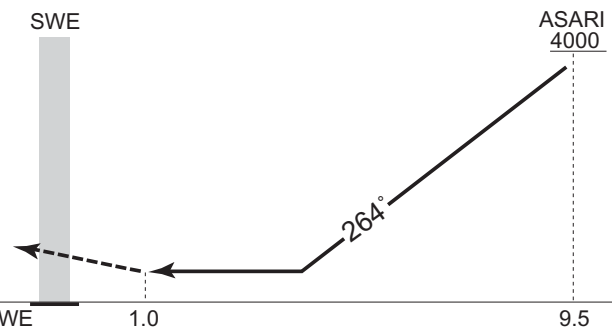

CHANGE : PROC renamed. VAR. MSA. Radial FM SWE.

MINIMA		AD elev. 21
CAT	CIRCLING	
	MDA(H)	VIS
A	1000 (979)	1600
B		2400
C		3200
D		

Circling to East side of RWY only.

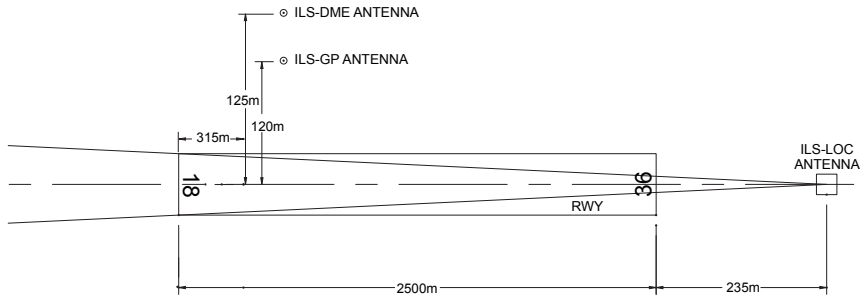
ILS for RWY 18

- REMARKS :
- | | |
|-------------------------|--------------|
| 1. LOC beam BRG(MAG) | 177° |
| 2. HGT of ILS REF datum | 16.5m (54ft) |
| 3. GP Angle | 3.0° |
| 4. ELEV of ILS-DME | 14m (45.9ft) |

