

AD 2 AERODROMES

RJEC AD 2.1 AERODROME LOCATION INDICATOR AND NAME

RJEC - ASAHIKAWA

RJEC AD 2.2 AERODROME GEOGRAPHICAL AND ADMINISTRATIVE DATA

1	ARP coordinates and site at AD	434015N/1422651E 154° / 1.25km from RWY16 THR
2	Direction and distance from (city)	7nm SSE from Asahikawa city
3	Elevation/ Reference temperature	690ft / 27°C(2004-2008)
4	Geoid undulation at AD ELEV PSN	105ft
5	MAG VAR/ Annual change	9°(2008) / -
6	AD Administration, address, telephone, telefax, telex, AFS, e-mail and/or Web-site addresses	Hokkaido Airports Co.,Ltd. Asahikawa Airport Office 15-96 Higashi-2-sen, Higashi-Kagura-cho, Kamikawa-gun, Hokkaido TEL:0166-83-2200 FAX:0166-83-3643 e-MAIL:hap-akj@hokkaido-airports.co.jp
7	Types of traffic permitted(IFR/VFR)	IFR/VFR
8	Remarks	Nil

RJEC AD 2.3 OPERATIONAL HOURS

1	AD Administration	2300 - 1200
2	Customs and immigration	Customs: 2330-0815 Immigration: INTL SKED FLT hours only
3	Health and sanitation	Quarantine(human): 2330-0815 Quarantine(animal, plant): INTL SKED FLT hours only
4	AIS Briefing Office	Nil
5	ATS Reporting Office(ARO)	Nil
6	MET Briefing Office	H24 (NEW CHITOSE)
7	ATS	2300 - 1200
8	Fuelling	2300 - 1200
9	Handling	2300 - 1200
10	Security	2300 - 1200
11	De-icing	Nil
12	Remarks	Nil

**RJEC AD 2.4 HANDLING SERVICES AND FACILITIES**

1	Cargo-handling facilities	A full range of cargo handling equipment is available up to B747-400 aircraft.
2	Fuel/ oil types	Fuel grades : JET A-1
3	Fuelling facilities/ capacity	Fuel truck refueling / Ask AD administration
4	De-icing facilities	Nil
5	Hangar space for visiting aircraft	Nil
6	Repair facilities for visiting aircraft	Nil
7	Remarks	Nil

**RJEC AD 2.5 PASSENGER FACILITIES**

1	Hotels	Nil
2	Restaurants	At airport
3	Transportation	Buses, taxi
4	Medical facilities	Nil
5	Bank and Post Office	At airport(ATM only)
6	Tourist Office	Nil
7	Remarks	Nil

**RJEC AD 2.6 RESCUE AND FIRE FIGHTING SERVICES**

1	AD category for fire fighting	CAT9
2	Rescue equipment	Chemical fire fighting truck x 3, Water-supply truck, Rescue and foam solution transport truck, Emergency medical equipments conveyance truck
3	Capability for removal of disabled aircraft	Ask AD administration
4	Remarks	Nil

**RJEC AD 2.7 SEASONAL AVAILABILITY-CLEARING**

1	Types of clearing equipment	Snow removal equipments: Sweeper x 7, Snowplow x 4, Rotary x 3, Grader x 2, Tractor-shovel x 3
2	Clearance priorities	(1) RWY 16/34, TWY T1, T5 (2) TWY T2 - T4, Apron
3	Remarks	Seasonal availability : All seasons

**RJEC AD 2.8 APRONS, TAXIWAYS AND CHECK LOCATIONS DATA**

1	Apron surface and strength	Spot NR1, 2, 3, 4, 5 : Surface : cement concrete, Strength : PCN 74/R/B/X/T Spot NR11, 12, 13, 14, 15 : Surface : cement concrete, Strength : PCN 11/R/B/Y/T
2	Taxiway width, surface and strength	T1 - T3, T5 ,A1 ,P1 ,P2 ,P5 : Width : 30m, Surface : asphalt-concrete, Strength : PCN 89/F/C/X/T T4, A2, P3, P4 : Width : 30m, Surface : asphalt-concrete, Strength : PCN 79/F/B/X/T
3	ACL and elevation	Not available
4	VOR checkpoints	Not available
5	INS checkpoints	Spot NR 1: 434018.01N/1422709.88E 2: 434016.16N/1422710.69E 3: 434014.59N/1422712.16E 4: 434012.59N/1422713.10E 5: 434010.62N/1422714.70E
6	Remarks	Nil

**RJEC AD 2.9 SURFACE MOVEMENT GUIDANCE AND CONTROL SYSTEM AND MARKINGS**

1	Use of aircraft stand ID signs, TWY guide lines and Visual docking/ parking guidance system of aircraft stands	ACFT stand identification signs installed as appropriate. ACFT stand taxi lane :Spot NR 1, 2, 3, 4, 5, 11, 12, 13, 14, 15
2	RWY and TWY markings and LGT	RWY: RWY16/34 (Marking) RWY designation, RWY CL, RWY THR, TDZ, RWY side stripe, Aiming point (LGT) RCLL, REDL, RTHL, RENL, RTZL(RWY34), WBAR, RWY DIST marker LGT  TWY: (Marking) TWY CL, TWY side stripe (LGT) TWY edge LGT, TWY CL LGT (Other than A1,A2), RWY guard LGT(T1-T5), Taxiing guidance sign (as appropriate)
3	Stop bars	Nil
4	Remarks	(Marking) Overrun area (LGT) Apron flood LGT

**RJEC AD 2.10 AERODROME OBSTACLES**

■ In Area2 See Obstacle data

■ In Area3 To be developed

## RJEC AD 2.11 METEOROLOGICAL INFORMATION PROVIDED

1	Associated MET Office	NEW CHITOSE
2	Hours of service MET Office outside hours	H24 (NEW CHITOSE)
3	Office responsible for TAF preparation Periods of validity	NEW CHITOSE 30 HoursNEW CHITOSE
4	Trend forecast Interval of issuance	Nil
5	Briefing/ consultation provided	Briefing is available upon inquiry at NEW CHITOSE
6	Flight documentation Language(s) used	C En
7	Charts and other information available for briefing or consultation	S <sub>6</sub> , U <sub>85</sub> , U <sub>7</sub> , U <sub>5</sub> , U <sub>3</sub> , U <sub>25</sub> , U <sub>2</sub> /T <sub>r</sub> , P <sub>s</sub> , P <sub>5</sub> , P <sub>3</sub> , P <sub>25</sub> , P <sub>SWE</sub> , P <sub>SWF</sub> , P <sub>SWG</sub> , P <sub>SWI</sub> , P <sub>SWM</sub> , P <sub>SW</sub> (domestic), E, C, W <sub>E</sub> , W <sub>F</sub> , W <sub>G</sub> , W <sub>I</sub> , W, N
8	Supplementary equipment available for providing information	Nil
9	ATS units provided with information	TWR
10	Additional information(limitation of service, etc.)	Nil

## RJEC AD 2.12 RUNWAY PHYSICAL CHARACTERISTICS

Designations RWY NR	TRUE BRG	Dimensions of RWY(M)	Strength(PCN) and surface of RWY	THR coordinates THR geoid undulation	THR elevation and highest elevation of TDZ of precision APP RWY
1	2	3	4	5	6
16	154.17°	2500×60	PCN 89/F/C/X/T Asphalt Concrete	434051.04N/1422626.96E 105.2ft	THR ELEV: 660ft
34	334.17°	2500×60	PCN 89/F/C/X/T Asphalt Concrete	433938.12N/1422715.59E 105.3ft	THR ELEV: 721ft TDZ ELEV: 717.7ft
Slope of RWY	Strip Dimensions(M)	RESA (Overrun) Dimensions(M)	Remarks		
7	10	11	14		
See AD2.24 AD CHART	2620×300  2620×300	135 × (MNM:226 MAX:300)*  190 × (MNM:220 MAX:300)*	RWY Grooving:2500×60m		
*For detail, ask airport administrator					

## RJEC AD 2.13 DECLARED DISTANCES

RWY Designator	TORA (m)	TODA (m)	ASDA (m)	LDA (m)	Remarks
1	2	3	4	5	6
16	2500	2500	2500	2500	Nil
34	2500	2500	2500	2500	Nil

**RJEC AD 2.14 APPROACH AND RUNWAY LIGHTING**

RWY Designator	APCH LGT type LEN INTST	RTHL Color WBAR	PAPI (VASIS) Angle DIST FM THR MEHT	RTZL LEN	RCLL LEN Spacing Color INTST	REDL LEN Spacing Color INTST	RENL Color WBAR	STWL LEN Color
1	2	3	4	5	6	7	8	9
16	SALS (*1) 420m LIH	Green Green	PAPI 3.0°/LEFT 400.2m 74ft	Nil	2,500m 30m Coded color (White/Red) LIH	2,500m 60m Coded color (White/Yellow) LIH	Red	Nil (*2)
34	PALS (CAT I) 900m LIH	Green Green	PAPI 3.0°/LEFT 499.2m 66ft	900m	2,500m 30m Coded color (White/Red) LIH	2,500m 60m Coded color (White/Yellow) LIH	Red	Nil (*2)
Remarks								
10								
SALS with APCH LGT beacon(906m and 596m FM RWY THR)(*1) Over run area edge LGT(LEN:60m,Color:Red)(*2)								

**RJEC AD 2.15 OTHER LIGHTING, SECONDARY POWER SUPPLY**

1	ABN/IBN location, characteristics and hours of operation	ABN: 434013N/1422718E, White/Green EV4.3sec,HO
2	LDI location and LGT Anemometer location and LGT	LDI:Nil Anemometer: RWY16:300m from RWY16 THR, LGTD RWY34: 430m from RWY34 THR, LGTD
3	TWY edge and center line lighting	TWY edge and center line lights installed, see AD2.9
4	Secondary power supply/ switch-over time	Within 1sec : REDL, RTHL, RENL, WBAR, RCLL, Overrun area edge LGT Within 15sec: Other LGT
5	Remarks	WDI LGT

**RJEC AD 2.16 HELICOPTER LANDING AREA**

Nil
-----

## RJEC AD 2.17 ATS AIRSPACE

Designation and lateral limits		Vertical limits (ft)	Airspace classification	ATS unit call sign Language	Remarks
1		2	3	4	6
Daisetsu CTR	Area within a radius of 5nm(9km) of Asahikawa / RJEC ARP (43°40'N 142°27'E)	4,000 or below (Exclude the area of Asahikawa Control Zone)	D	Daisetsu Tower En	

## RJEC AD 2.18 ATS COMMUNICATION FACILITIES

Service designation	Call sign	Frequency	Hours of operation	Remarks
1	2	3	4	5
TWR	Daisetsu Tower	118.55MHz(1) 126.2MHz 121.5MHz(E) 243.0MHz(E)	2300 - 1200	(1)Primary

## RJEC AD 2.19 RADIO NAVIGATION AND LANDING AIDS

Type of aid (VOR declination)	ID	Frequency	Hours of operation	Position of transmitting antenna coordinates	Elevation of DME transmitting antenna	Remarks
1	2	3	4	5	6	7
VOR (9°W/2018)	AWE	113.5MHz	H24	434002.15N/ 1422724.65E		VOR/DME Unusable: 080°-090° beyond 35nm BLW 9000ft.  VOR Unusable: 090°-110° beyond 35nm BLW 10000ft. 110°-130° beyond 30nm BLW 10000ft. 130°-170° beyond 35nm BLW 10000ft.
DME	AWE	1169MHz (CH-82X)	H24	434002.15N/ 1422724.65E	769ft	DME Unusable: 090°-110° beyond 25nm BLW 10000ft. 110°-170° beyond 30nm BLW 10000ft. 220°-230° beyond 30nm BLW 6000ft. 230°-240° beyond 35nm BLW 6000ft. 240°-260° beyond 20nm BLW 6000ft. 260°-290° beyond 35nm BLW 7000ft.
ILS-LOC 34	IAW	110.5MHz	2300 - 1200	434057.88N/ 1422622.40E		LOC: 235m(771ft) away FM RWY16 THR, BRG (MAG) 343°.
ILS-GP 34	-	329.6MHz	2300 - 1200	433947.05N/ 1422703.34E		GP: 368m(1207ft) inside FM RWY 34 THR, 126m(413ft) W of RCL. HGT of ILS Ref datum 16.5m. Angle 3.0°
ILS-DME 34	IAW	1003MHz (CH-42X)	2300 - 1200	433947.34N/ 1422702.97E	727ft	DME: 379m(1243ft) inside FM RWY 34 THR, 130m(427ft) W of RCL.
MSAS		1575.42MHz	H24			Transmitting antennas are satellite based

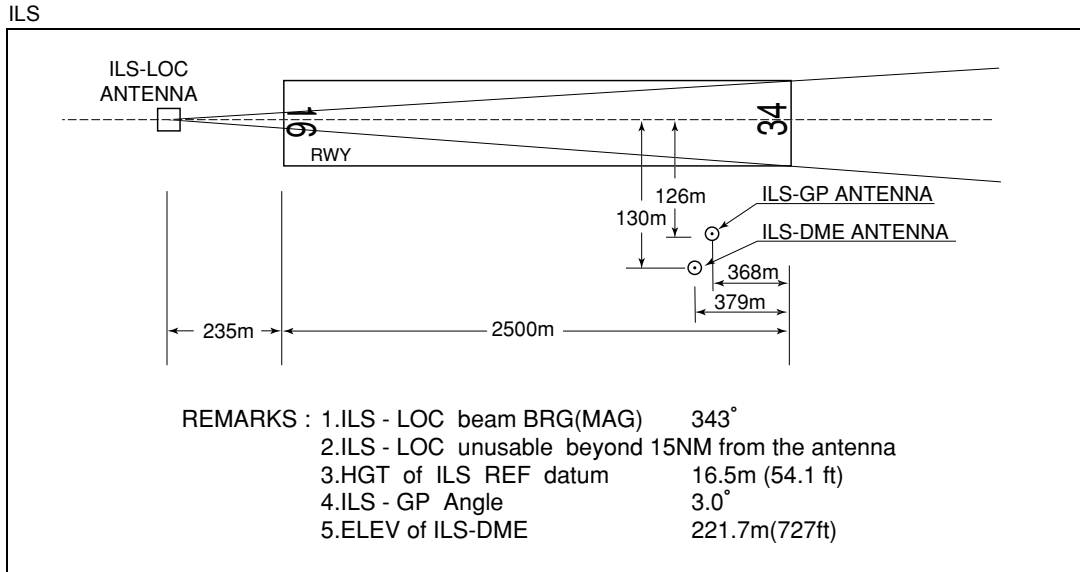

**RJEC AD 2.20 LOCAL TRAFFIC REGULATIONS**

1. Airport regulations

PPR  
 Prior permission is required for transient aircraft due to parking congestion except scheduled and/or emergency flight.  
 Tel : Hokkaido Airports Co., Ltd. Asahikawa Airport Office 0166-83-2200

2. Taxiing to and from stands

Nil

3. Parking area for small aircraft(General aviation)

Nil

4. Parking area for helicopters

Nil

5. Apron - taxiing during winter conditions

Nil

6. Taxiing - limitations

1.Wing tip clearance at the TWY intersection (REF. AD1.1 item 6.8)  
 Wing tip clearance at the TWY intersection between the ACFT holding at the stop marking on the TWY and the other ACFT taxiing behind it are as follows.

When A306 holding at the stop marking on TWY T2,T3 or T4.

Wing span(WS) of ACFT taxiing on TWY P1-P5	WS<=59.8m	59.8m<WS<=76.8 m	WS>76.8m
Wing tip clearance	A*	B*	C*

Legend :  
 A\*:Wing tip clearance >=15m  
 B\*:6.5m<=Wing tip clearance <15m  
 C\*:Wing tip clearance<6.5m

## 7. School and training flights - technical test flights - use of runways

Nil

## 8. Helicopter traffic - limitation

Nil

## 9. Removal of disabled aircraft from runways

Nil

**RJEC AD 2.21 NOISE ABATEMENT PROCEDURES**

Nil

**RJEC AD 2.22 FLIGHT PROCEDURES****1.TAKE OFF MINIMA**

	RWY	ACFT CAT	REDL & RCLL		REDL or RCLL or RCL marking		NIL (DAYTIME ONLY)	
			RVR	VIS	RVR	VIS	RVR	VIS
Multi-Engine ACFT with TKOF ALTN AP FILED	16	A,B,C,D	-	400m	-	400m	-	500m
	34	A,B,C,D	400m	400m	400m	400m	-	500m
Other	16	A,B,C,D	AVBL LDG MINIMA					
	34	A,B,C,D						

**RJEC AD 2.23 ADDITIONAL INFORMATION**

Nil

**RJEC AD 2.24 CHARTS RELATED TO AN AERODROME**

Aerodrome/Heliport Chart  
 Standard Departure Chart - Instrument (KAGRA, ASAHIKAWA REVERSAL)  
 Standard Arrival Chart - Instrument (OSOBA-RNAV)  
 Instrument Approach Chart (ILS Z or LOC Z RWY34)  
 Instrument Approach Chart (ILS Y or LOC Y RWY34)  
 Instrument Approach Chart (VOR A)  
 Instrument Approach Chart (VOR B)  
 Instrument Approach Chart (VOR C)  
 Instrument Approach Chart (RNAV(GNSS) Z RWY16)  
 Instrument Approach Chart (RNAV(RNP) Y RWY16)  
 Other Chart (Visual REP)  
 Other Chart (MVA CHART)



RJEC / ASAHIKAWA

AD CHART

CHANGE : ACFT Stand Lead-in Lines for spot 1 and 2

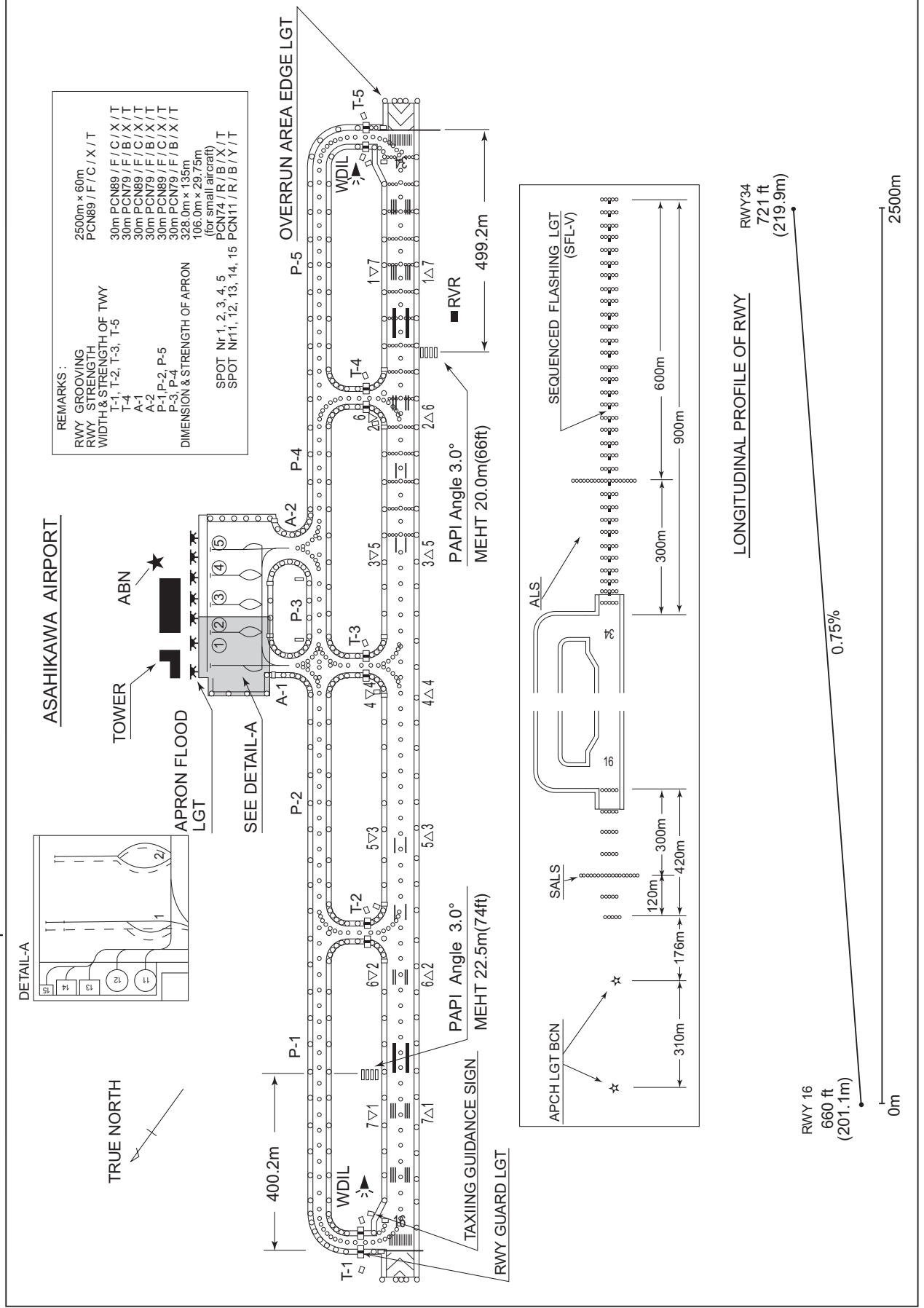

STANDARD ARRIVAL CHART-INSTRUMENT

RJEC / ASAHIKAWA

RNAV STAR RWY16

OSOBA ARRIVAL

Basic RNP1

Note GNSS required.

VAR 10° W(2017)

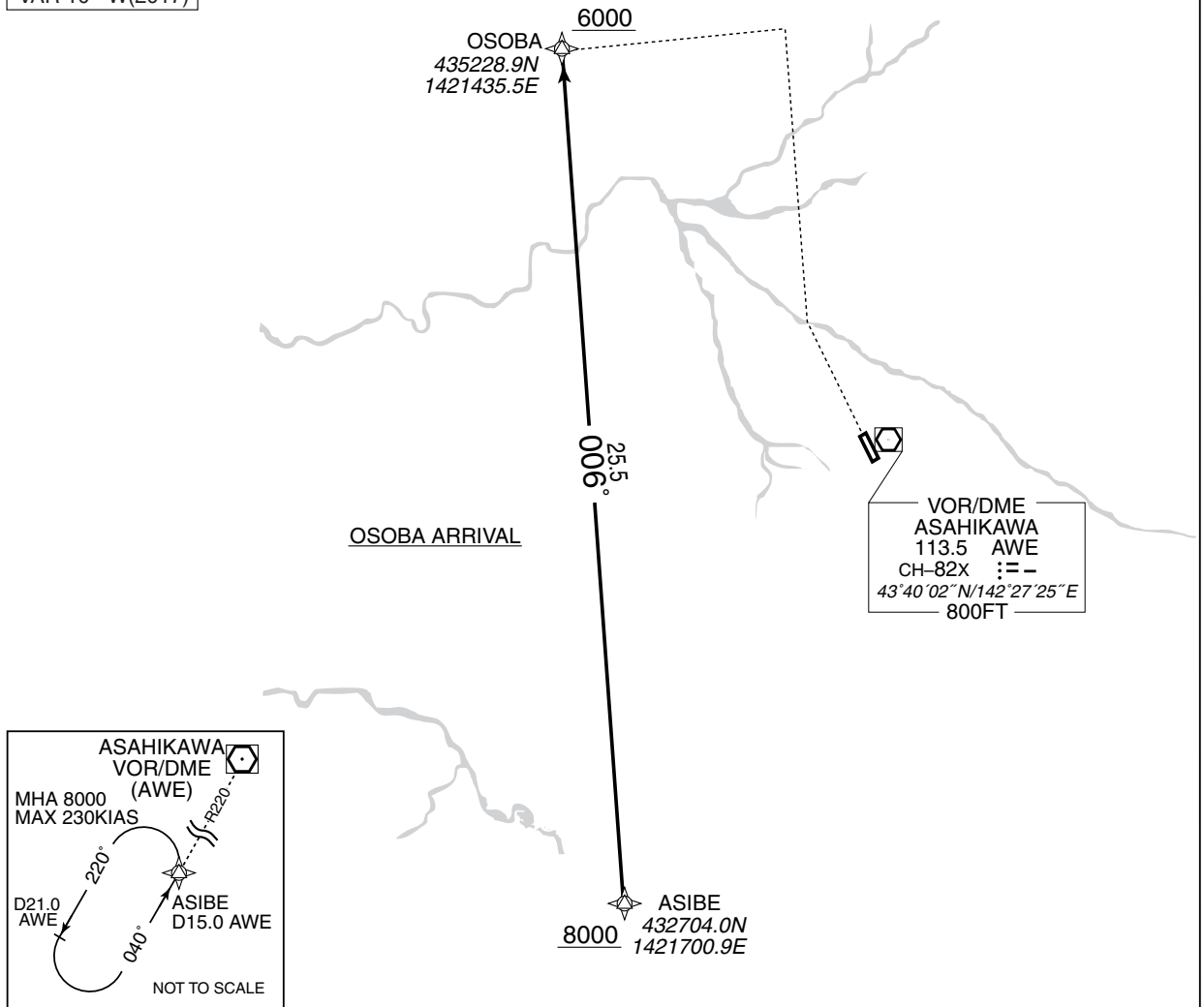

OSOBA ARRIVAL

From ASIBE at or above 8000FT, to OSOBA at or above 6000FT.

Serial Number	Path Descriptor	Waypoint Identifier	Fly Over	Course °M(°T)	Magnetic Variation	Distance (NM)	Turn Direction	Altitude (FT)	Speed (KIAS)	Vertical Angle	Navigation Specification
001	IF	ASIBE	-	-	-9.5	-	-	+8000	-	-	Basic RNP1
002	TF	OSOBA	-	006 (356.1)	-9.5	25.5	-	+6000	-	-	Basic RNP1

INSTRUMENT APPROACH CHART

RJEC / ASAHIKAWA

RNAV(GNSS) Z RWY16

SAPPORO CONTROL 132.6 – 255.2 134.25 – 260.4	1. DME/DME RNP0.3 not authorized. 2. RNP0.3 required. 3. GNSS required.	DAISETSU TOWER 118.55 – 126.2	NO RADAR
----------------------------------------------------	-------------------------------------------------------------------------------	----------------------------------	----------

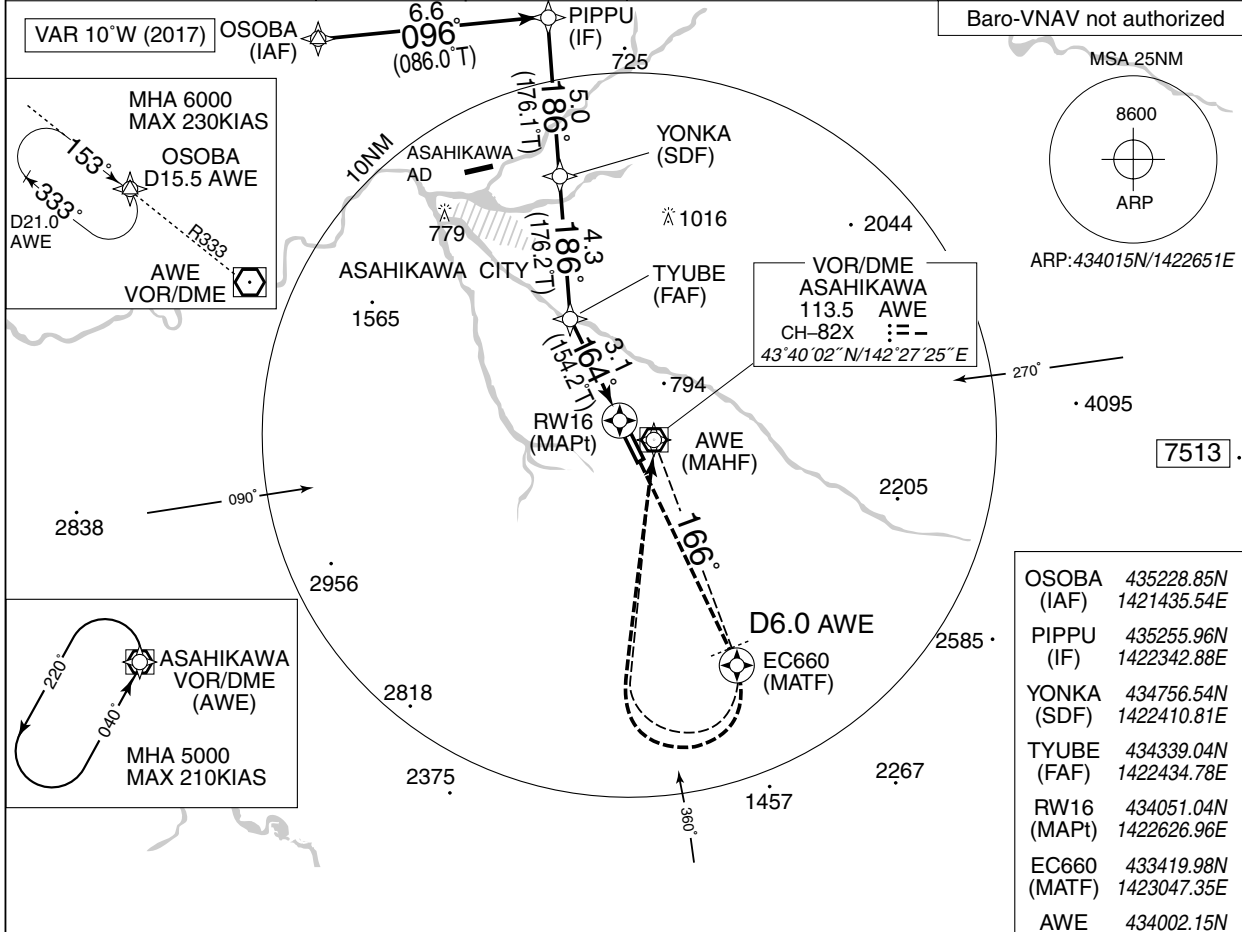

NM to Next Fix	FAF	3	2	1	MAPt
ALT (3.0° APCH Path)	1700	1664	1346	1027	-

OSOBA (IAF)	435228.85N 1421435.54E
PIPPU (IF)	435255.96N 1422342.88E
YONKA (SDF)	434756.54N 1422410.81E
TYUBE (FAF)	434339.04N 1422434.78E
RW16 (MAPt)	434051.04N 1422626.96E
EC660 (MATF)	433419.98N 1423047.35E
AWE (MAHF)	434002.15N 1422724.65E

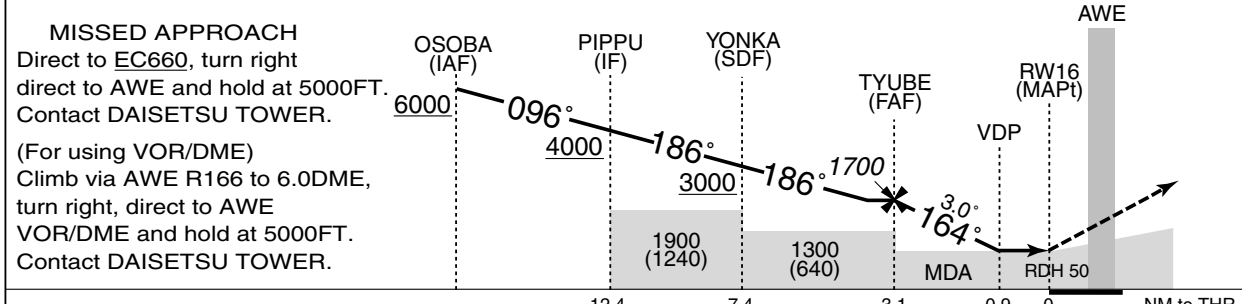

MISSED APPROACH  
Direct to EC660, turn right direct to AWE and hold at 5000FT. Contact DAISETSU TOWER.  
(For using VOR/DME)  
Climb via AWE R166 to 6.0DME, turn right, direct to AWE VOR/DME and hold at 5000FT. Contact DAISETSU TOWER.

Missed APCH climb gradient MNM 3.1%

MINIMA		THR elev. 660		AD elev. 690		
CAT	LNAV/VNAV		LNAV		CIRCLING	
	DA(H)	CMV	MDA(H)	CMV	MDA(H)	VIS
A	Not applicable	1000 (340)	1000 (340)	1200	1280 (590)	1600
B				1300	1330 (640)	
C				1400	1560 (870)	2400
D				1600		

MINIMA with Missed APCH climb gradient of 2.5% are not established.

RJEC / ASAHIKAWA

Minimum Vectoring Altitude CHART

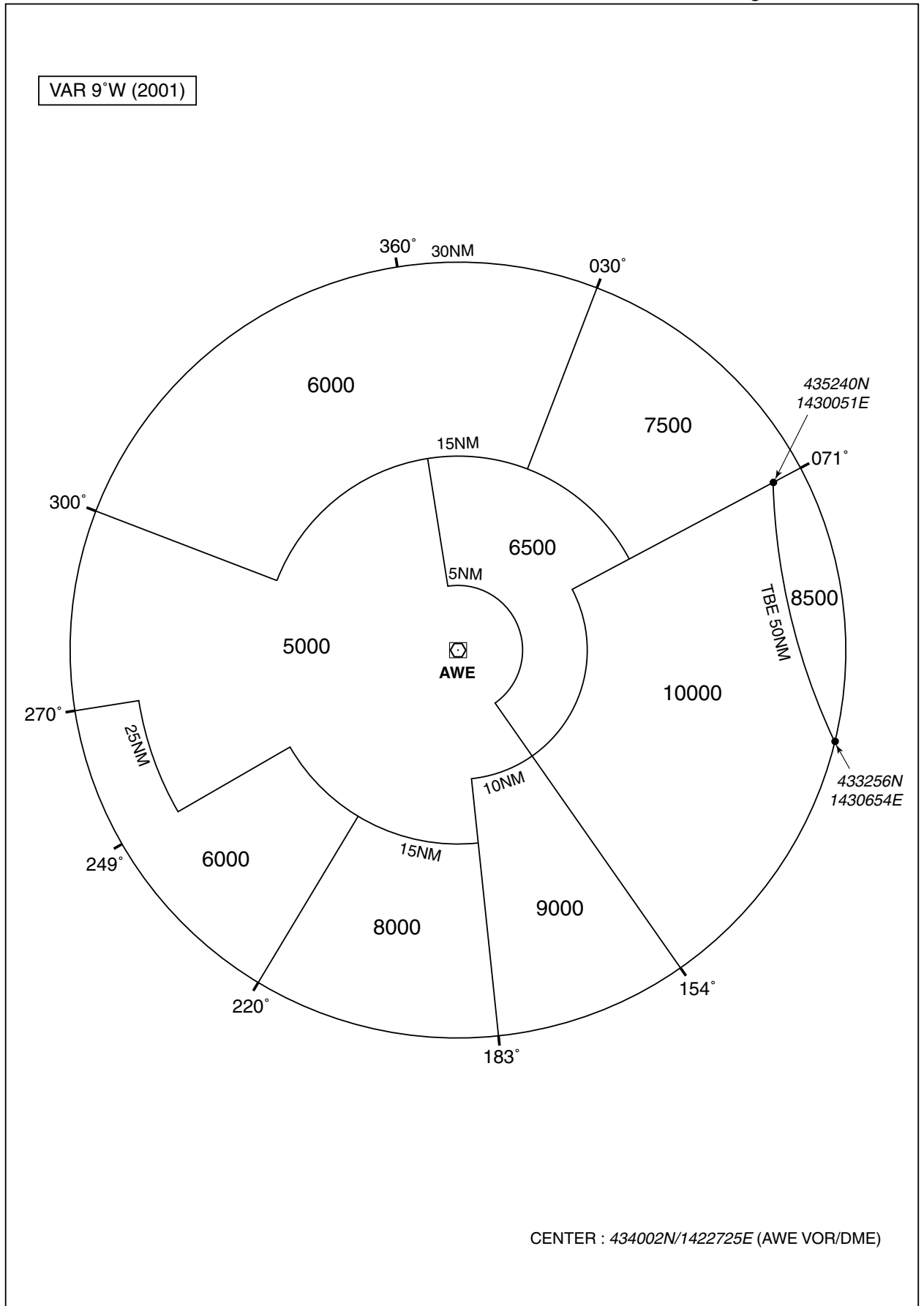

**INTENTIONALLY LEFT BLANK**

INSTRUMENT APPROACH CHART

RJEC / ASAHIKAWA

➔ RNAV(RNP) Y RWY16

SAPPORO CONTROL 132.6 – 255.2 134.25 – 260.4	GNSS and RF required.	DAISETSU TOWER 118.55 – 126.2	NO RADAR
----------------------------------------------------	-----------------------	----------------------------------	----------

For uncompensated Baro-VNAV systems, procedure not authorized below -30°C / above 45°C

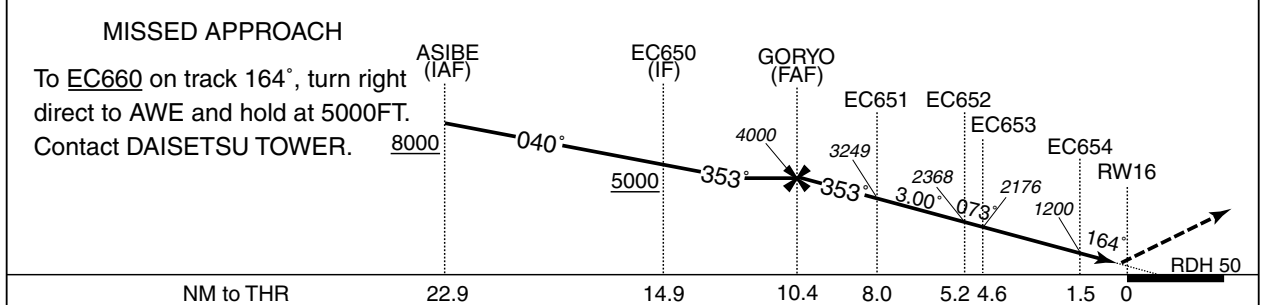
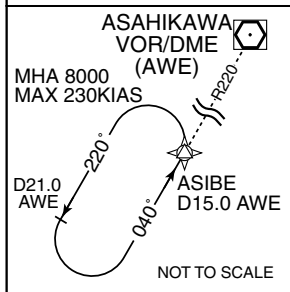
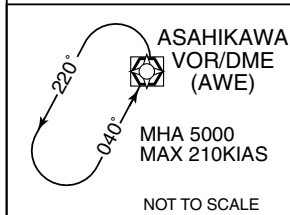
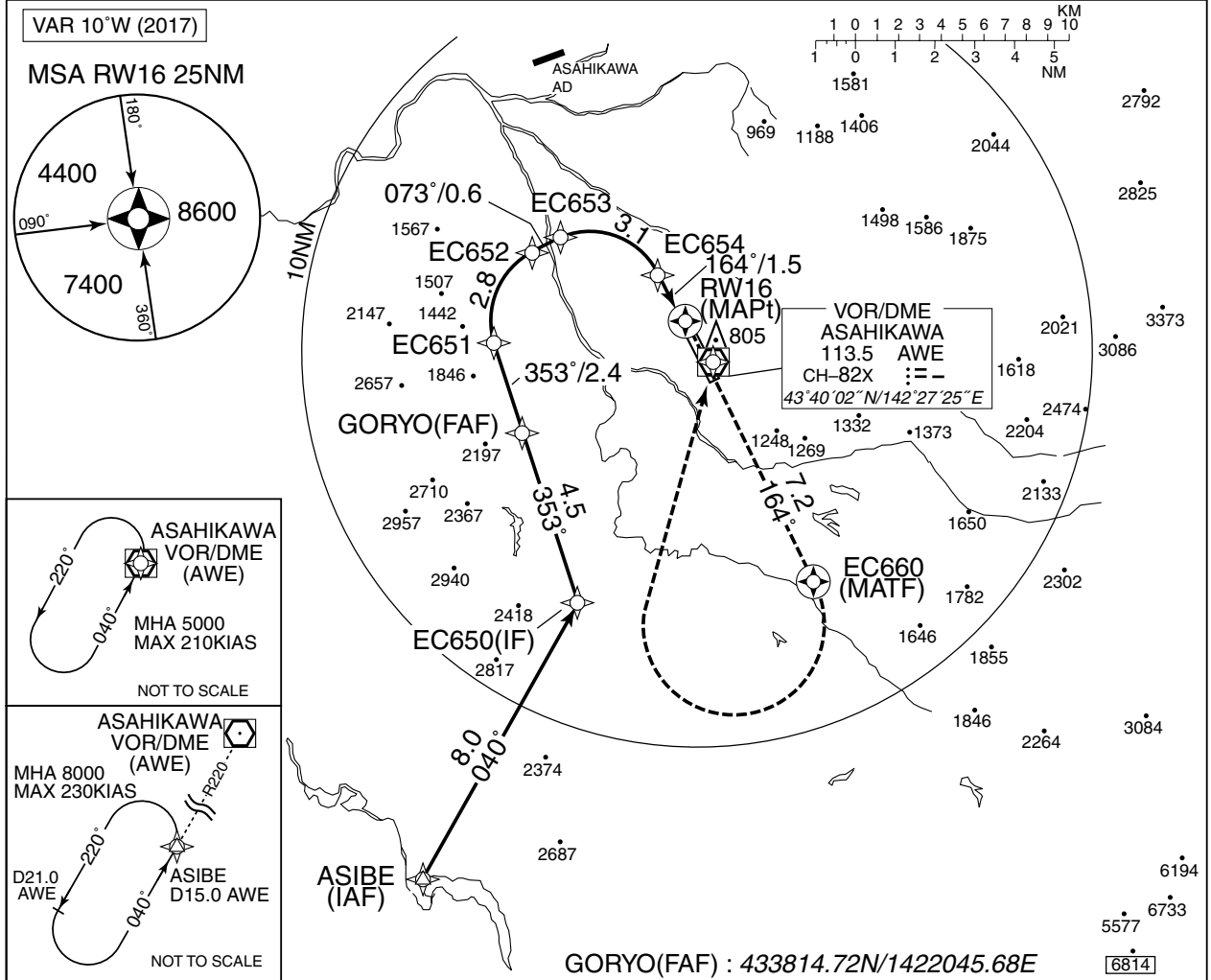

MISSED APCH climb gradient MNM 3.0%

MINIMA	THR elev.660	AD elev.690
RNP 0.30		
CAT	DA(H)	CMV
A	-	-
B	-	-
C	960 (300)	1400
D	-	-

**RNP AR**  
 Special Authorization Required

MINIMA with Missed APCH climb gradient of 2.5% are not established.

## INSTRUMENT APPROACH CHART

RJEC / ASAHIKAWA

➔ RNAV(RNP) Y RWY16

RNAV (RNP) Y RWY16Coding Table

Serial Number	Path Descriptor	Waypoint Identifier	Fly Over	Course *M(T)	Magnetic Variation	Distance (NM)	Turn Direction	Altitude (FT)	Speed (KIAS)	VPA/RDH (°/FT)	RNP Value
001	IF	ASIBE	-	-	-9.5	-	-	+8000	-	-	-
002	TF	EC650	-	040 (030.1)	-9.5	8.0	-	+5000	-	-	1.0
003	TF	GORYO	-	353 (343.1)	-9.5	4.5	-	4000	-	-	1.0
004	TF	EC651	-	353 (343.0)	-9.5	2.4	-	3249	-	-3.00	0.30
005	RF Center: ECRF1 r=1.98NM	EC652	-	-	-9.5	2.8	R	2368	-	-3.00	0.30
006	TF	EC653	-	073 (063.0)	-9.5	0.6	-	2176	-	-3.00	0.30
007	RF Center: ECRF2 r=1.93NM	EC654	-	-	-9.5	3.1	R	1200	-	-3.00	0.30
008	TF	RW16	Y	164 (154.2)	-9.5	1.5	-	710	-	-3.00/50	0.30
009	CF	EC660	Y	164 (154.2)	-9.5	7.2	-	-	-	-	1.0
010	DF	AWE	-	-	-9.5	-	R	5000	-	-	1.0

Waypoint Coordinates

Waypoint Identifier	Coordinates	RF Arc Center Identifier	Coordinates
ASIBE	432703.98N/1421700.93E	ECRF1	434104.78N/1422225.25E
EC650	433359.28N/1422233.14E	ECRF2	434123.69N/1422307.68E
GORYO	433814.72N/1422045.68E		
EC651	434030.03N/1421948.65E		
EC652	434250.78N/1422111.17E		
EC653	434307.07N/1422155.45E		
EC654	434214.29N/1422531.40E		
RW16	434051.04N/1422626.96E		
EC660	433419.98N/1423047.35E		
AWE	434002.15N/1422724.65E		

STANDARD DEPARTURE CHART-INSTRUMENT

RJEC / ASAHIKAWA

SID

KAGRA FOUR DEPARTURE

RWY16 : Climb RWY HDG to 1600FT, turn left,...

RWY34 : Climb via AWE R337 to 2.3DME, turn right,...

...direct to AWE VOR/DME, via AWE R283 to KAGRA.

Cross AWE VOR/DME at or above 4000FT, cross KAGRA at or above 5000FT.

Note RWY16 : 5.3% climb gradient required up to 1600FT.

OBST ALT 1247FT located at 2.0NM 146° FM end of RWY16.

RWY34 : 5.0% climb gradient required up to 1000FT.

OBST ALT 696FT located at 1.4NM 021° FM end of RWY34.

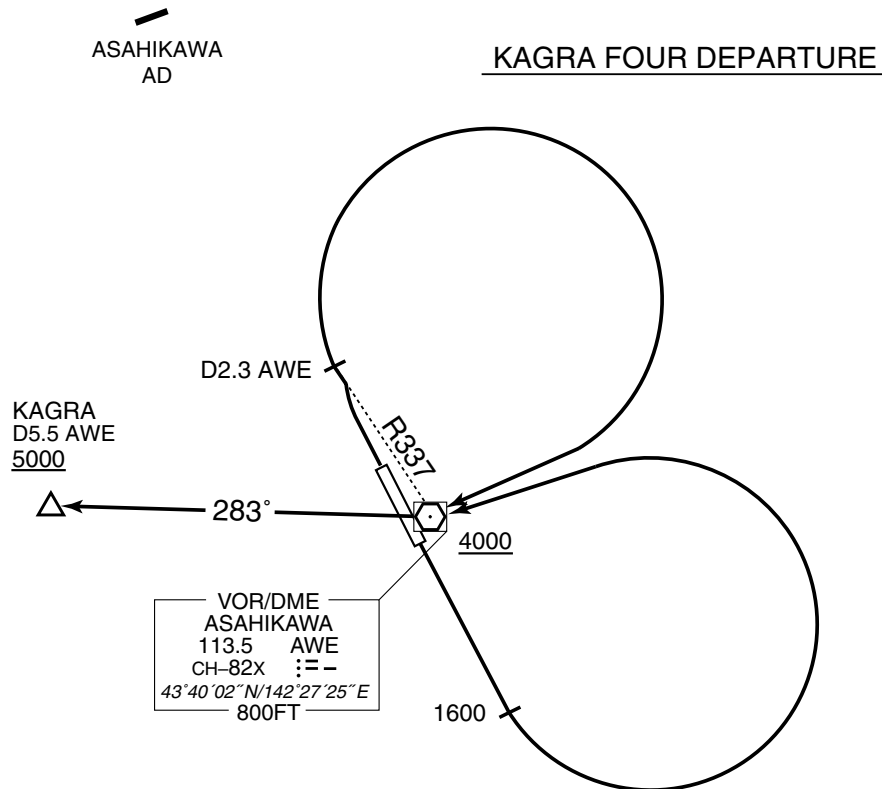



STANDARD DEPARTURE CHART-INSTRUMENT

RJEC / ASAHIKAWA

SID

ASAHIKAWA REVERSAL FIVE DEPARTURE

RWY16 : Climb RWY HDG to 1600FT, turn left HDG320° to intercept and proceed ...

RWY34 : Climb via AWE R337 to 2.3DME, turn right,...

... via AWE R005 to 8.5DME, turn right, direct to AWE VOR/DME.

Cross AWE VOR/DME at or above 5000FT (8000FT for East bound).

Note RWY16 : 5.3% climb gradient required up to 1600FT.

OBST ALT 1247FT located at 2.0NM 146° FM end of RWY16.

ASAHIKAWA REVERSAL FIVE DEPARTURE

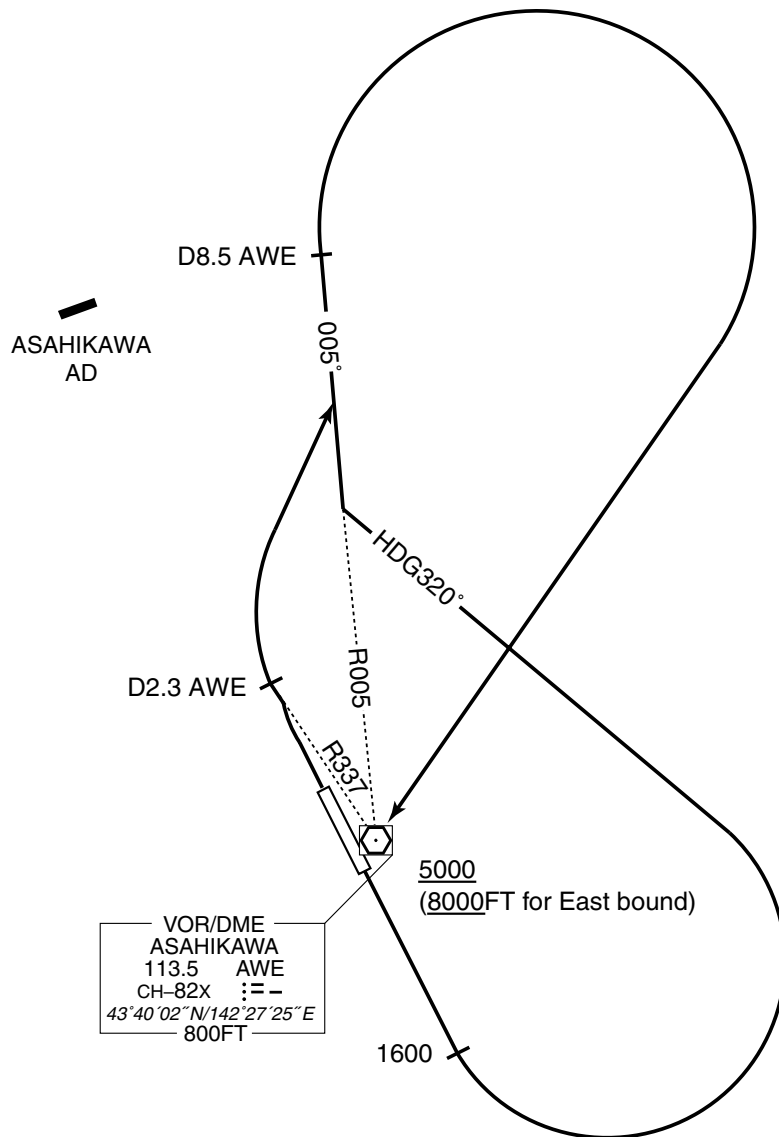

INSTRUMENT APPROACH CHART

RJEC / ASAHIKAWA ILS Z or LOC Z RWY34

SAPPORO CONTROL 132.6 – 255.2 134.25 – 260.4	ILS-LOC 110.5 IAW ::- ILS-GP 329.6 ILS-DME CH-42X	DAISETSU TOWER 118.55 – 126.2	NO RADAR
----------------------------------------------------	------------------------------------------------------------	----------------------------------	----------

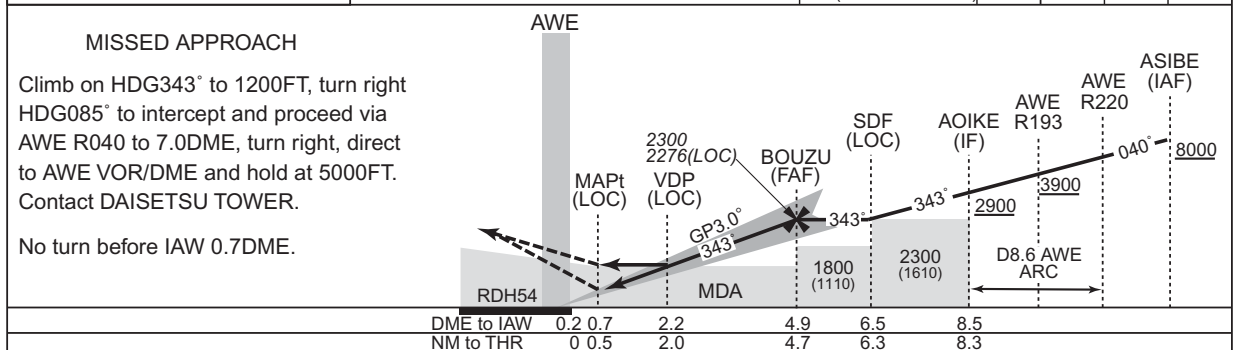
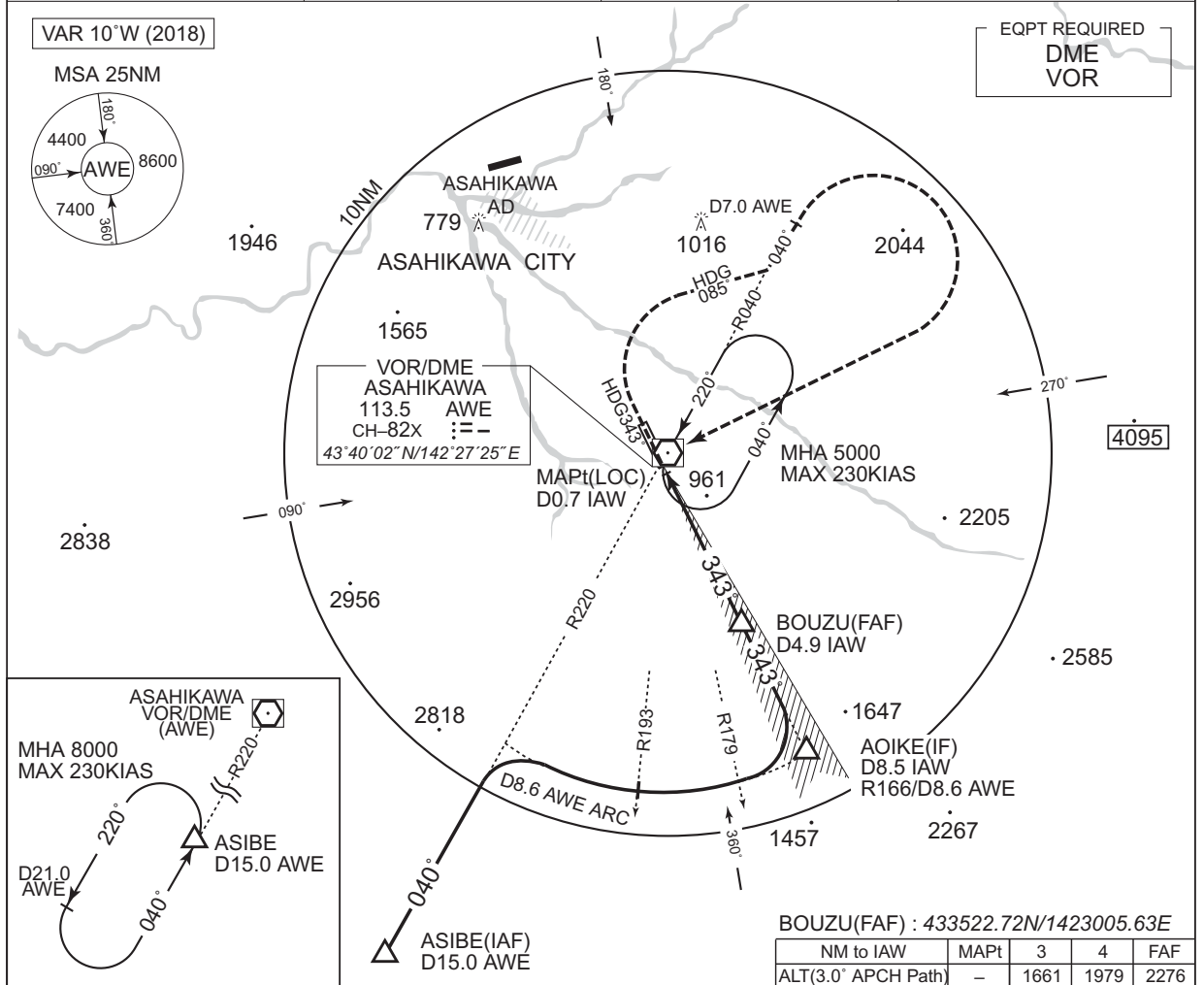

CHANGE: GP angle added.

Missed APCH climb gradient MNM 5.0%

CAT	CAT I		LOC		CIRCLING	
	DA(H)	RVR/CMV	MDA(H)	RVR/CMV	MDA(H)	VIS
A	921(200)	550	1370(680)	1200	1370(680)	1600
B				1400		
C				1560(870)	2400	
D				1800	3200	

MINIMA with Missed APCH climb gradient of 2.5% are not established.

INSTRUMENT APPROACH CHART

RJEC / ASAHIKAWA

ILS Y or LOC Y RWY34

SAPPORO CONTROL 132.6 – 255.2 134.25 – 260.4	ILS-LOC 110.5 IAW :≡- ILS-GP 329.6 ILS-DME CH-42X	DAISETSU TOWER 118.55 – 126.2	NO RADAR
----------------------------------------------------	------------------------------------------------------------	----------------------------------	----------

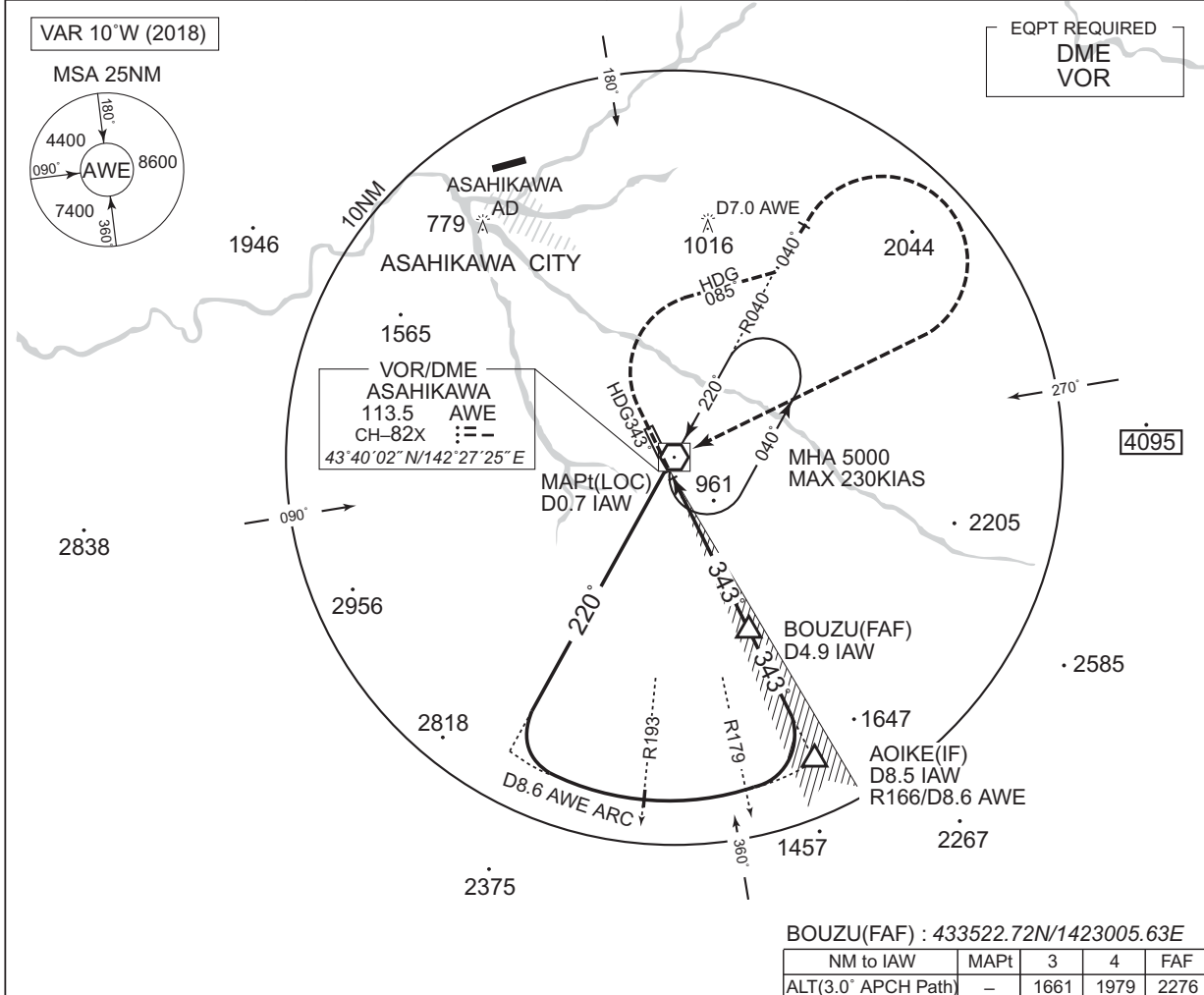

MISSED APPROACH

Climb on HDG343° to 1200FT, turn right HDG085° to intercept and proceed via AWE R040 to 7.0DME, turn right, direct to AWE VOR/DME and hold at 5000FT. Contact DAISETSU TOWER.

No turn before IAW 0.7DME.

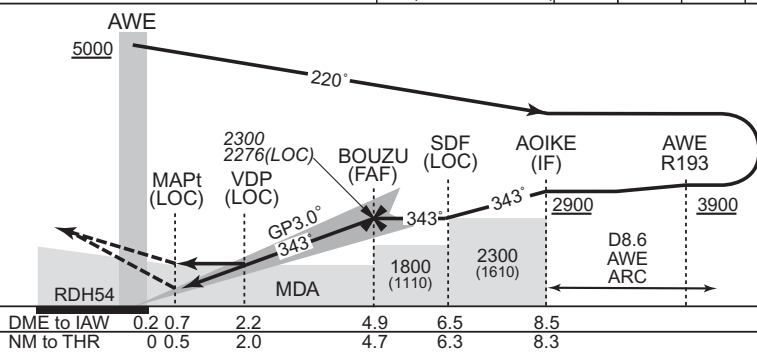

Missed APCH climb gradient MNM 5.0%

MINIMA		THR elev. 721		AD elev. 690		
CAT	CAT I		LOC		CIRCLING	
	DA(H)	RVR/CMV	MDA(H)	RVR/CMV	MDA(H)	VIS
A	921(200)	550	1370(680)	1200	1370(680)	1600
B				1400		
C				1560(870)	2400	
D						3200

MINIMA with Missed APCH climb gradient of 2.5% are not established.

CHANGE: GP angle added.

INSTRUMENT APPROACH CHART

RJEC / ASAHIKAWA

VOR A

SAPPORO CONTROL 132.6 – 255.2 134.25 – 260.4	ASAHIKAWA VOR/DME 113.5 AWE CH-82X :- 43°40'02"N / 142°27'25"E	DAISETSU TOWER 118.55 – 126.2	NO RADAR
----------------------------------------------------	-------------------------------------------------------------------------	----------------------------------	----------

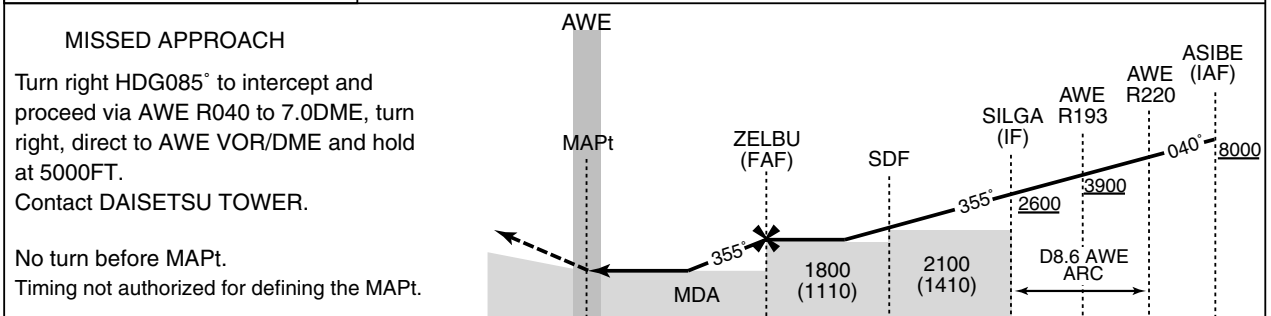
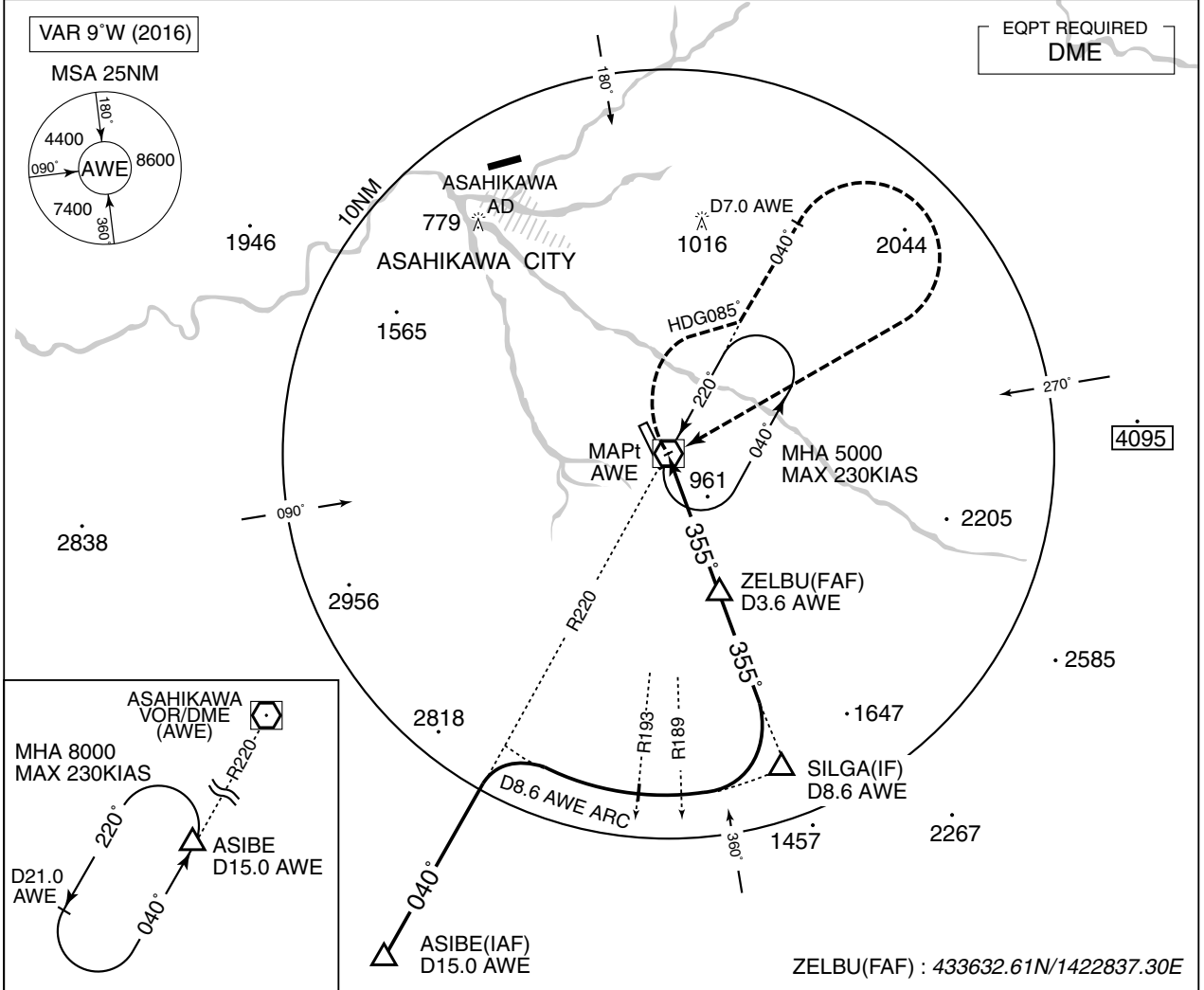

Missed APCH climb gradient MNM 5.0%

MINIMA		AD elev. 690
CAT	CIRCLING	
	MDA(H)	VIS
A	1460(770)	1600
B	1560(870)	2400
C		3200
D		

MINIMA with Missed APCH climb gradient of 2.5% are not established.

INSTRUMENT APPROACH CHART

RJEC / ASAHIKAWA

VOR B

SAPPORO CONTROL 132.6 – 255.2 134.25 – 260.4	ASAHIKAWA VOR/DME 113.5 AWE CH-82X :=-- 43°40'02"N / 142°27'25"E	DAISETSU TOWER 118.55 – 126.2	NO RADAR
----------------------------------------------------	---------------------------------------------------------------------------	----------------------------------	----------

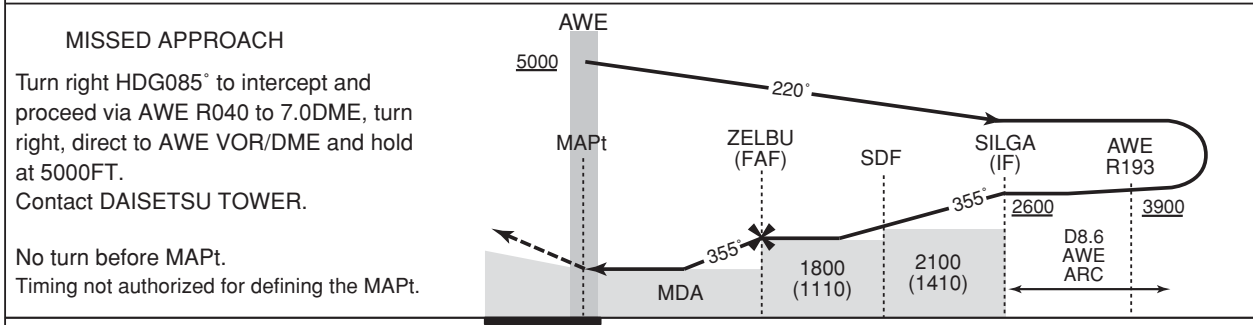
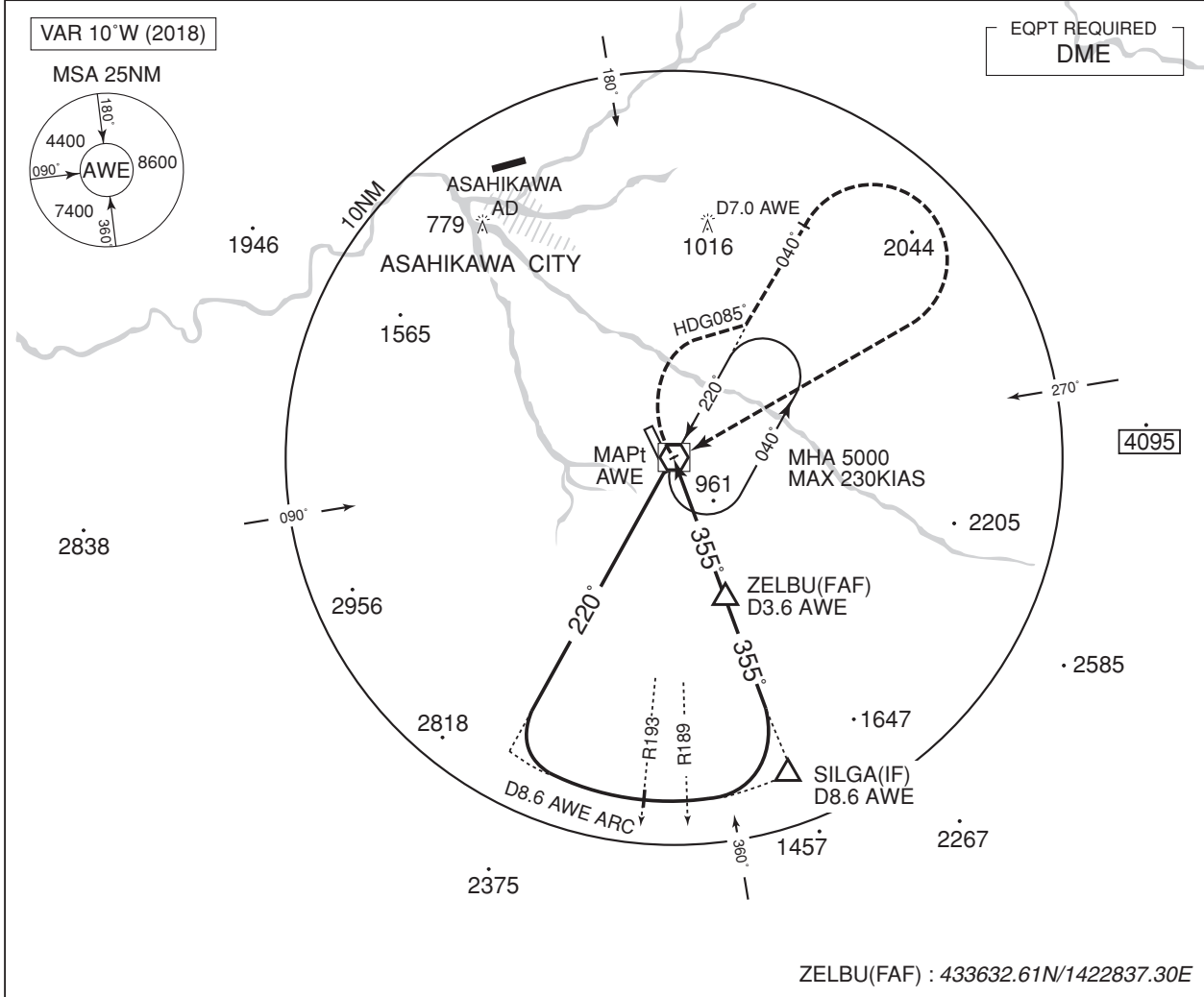

Missed APCH climb gradient MNM 5.0%

MINIMA		AD elev. 690
CAT	CIRCLING	
	MDA(H)	VIS
A	1460(770)	1600
B	1560(870)	2400
C		3200
D		

MINIMA with Missed APCH climb gradient of 2.5% are not established.

CHANGE : VAR

INSTRUMENT APPROACH CHART

RJEC / ASAHIKAWA

VOR C

SAPPORO CONTROL 132.6 – 255.2 134.25 – 260.4	ASAHIKAWA VOR/DME 113.5 AWE CH-82X :=- 43°40'02"N / 142°27'25"E	DAISETSU TOWER 118.55 – 126.2	NO RADAR
----------------------------------------------------	--------------------------------------------------------------------------	----------------------------------	----------

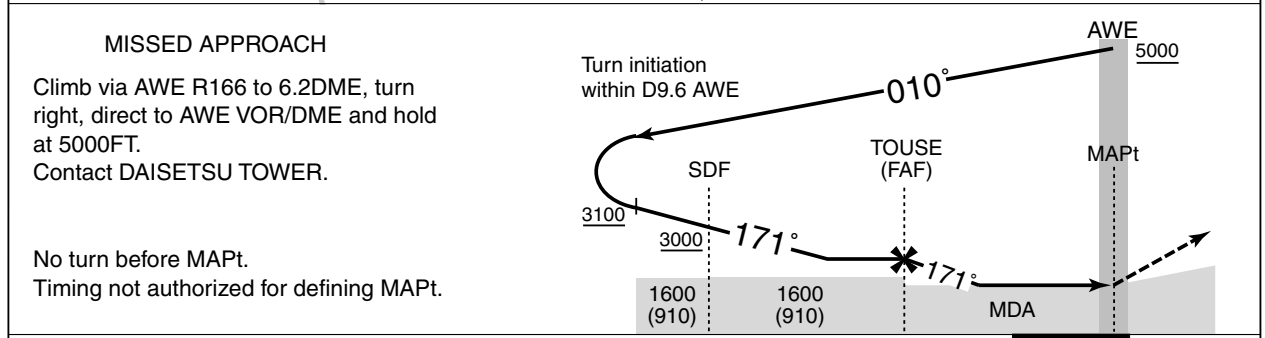
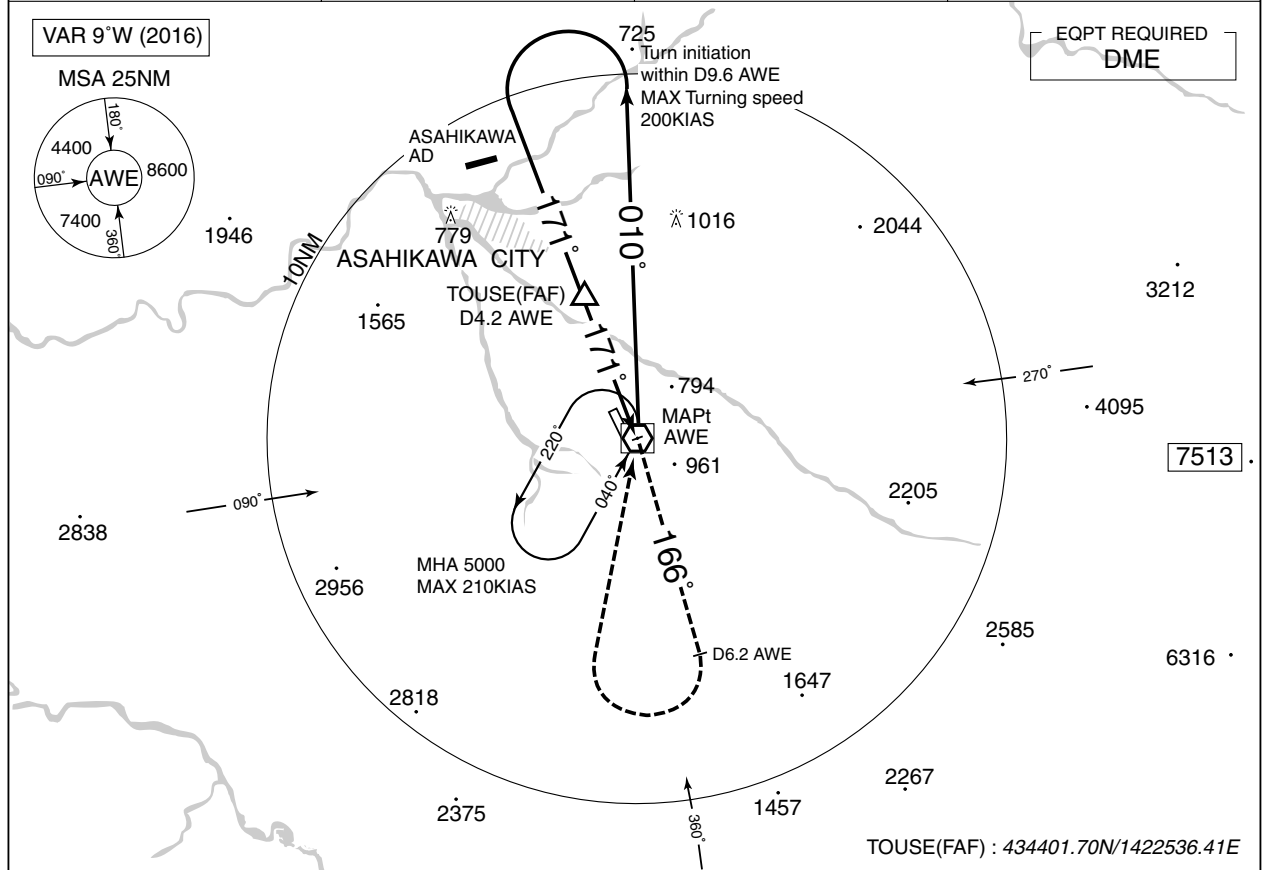

MINIMA		AD elev. 690
CAT	CIRCLING	
	MDA(H)	VIS
A	1330 (640)	1600
B		
C	1560 (870)	2400
D		3200



RJEC / ASAHIKAWA

Visual REP

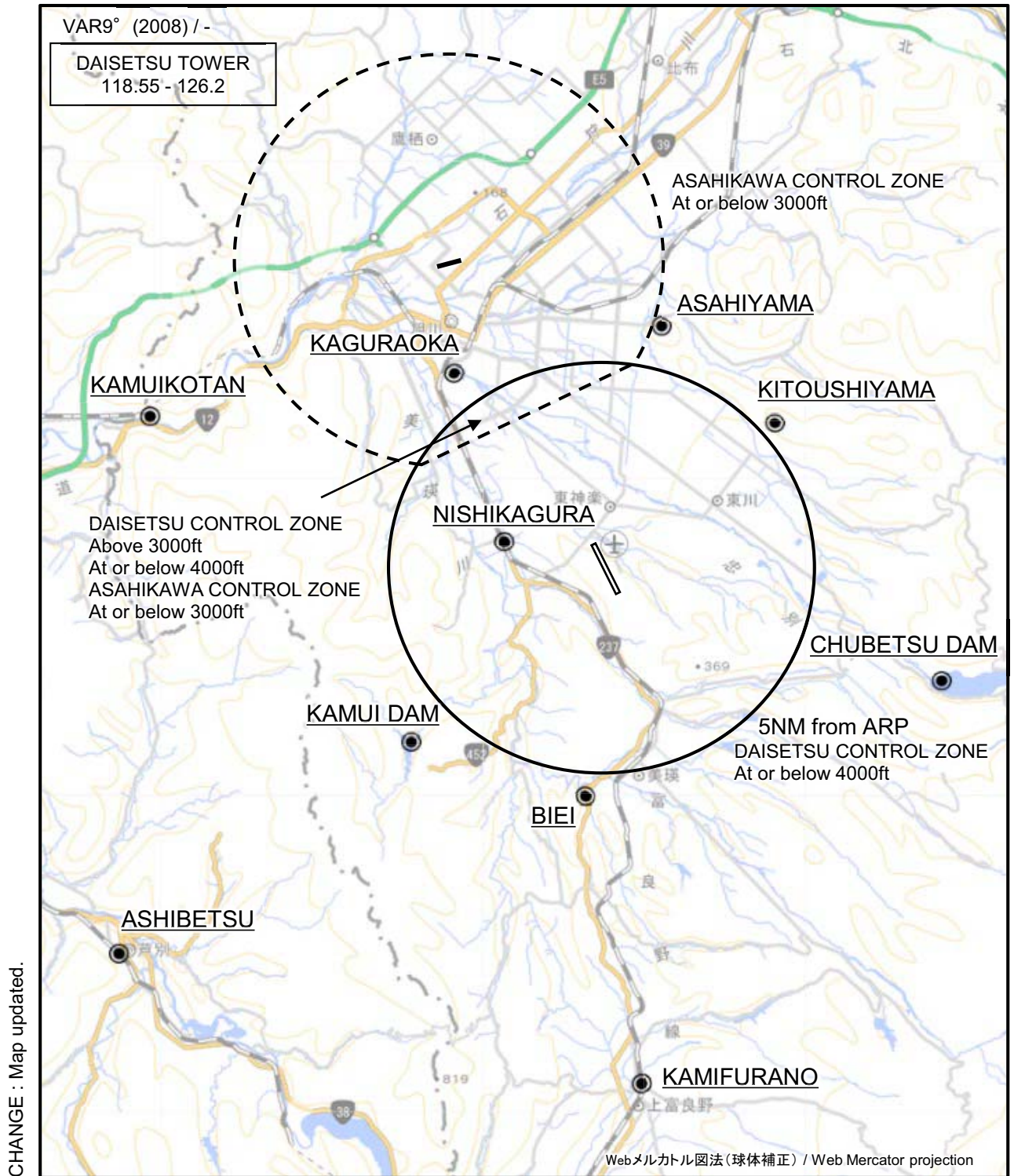

※図中に標高を示す数字がある場合、単位はメートル(m)である。The unit of measurement used to express elevation is meter(m).

RJEC / ASAHIKAWA

Visual REP

Call sign	BRG / DIST from ARP	Remarks
旭山 Asahiyama	014°T / 6.0NM	旭山動物園 Zoo
神楽岡 Kaguraoka	324°T / 5.9NM	神楽岡公園 Park
神居古潭 Kamuikotan	289°T / 11.3NM	橋 Bridge
岐登牛山 Kitoushiyama	049°T / 5.4NM	スキー場 Ski ground
西神楽 Nishikagura	286°T / 2.4NM	JR駅 Station
忠別ダム Chubetsu dam	108°T / 8.5NM	ダム Dam
神居ダム Kamui dam	227°T / 6.2NM	ダム Dam
美瑛 Biei	184°T / 5.5NM	道路(大曲) Road
芦別 Ashibetsu	231°T / 14.7NM	JR駅 Station
上富良野 Kamifurano	176°T / 12.4NM	JR駅 Station

CHANGE : BRG/DIST from ARP.



ASAHIKAWA AP

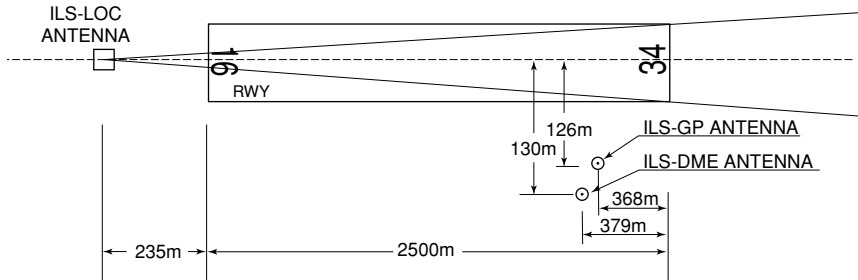

- REMARKS :
- |                                                   |                 |
|---------------------------------------------------|-----------------|
| 1.ILS - LOC beam BRG(MAG)                         | 343°            |
| 2.ILS - LOC unusable beyond 15NM from the antenna |                 |
| 3.HGT of ILS REF datum                            | 16.5m (54.1 ft) |
| 4.ILS - GP Angle                                  | 3.0°            |
| 5.ELEV of ILS-DME                                 | 221.7m(727ft)   |